

N-Channel Enhancement Mode Power MOSFET

Description

The G1K3N10G uses advanced trench technology to provide excellent $R_{DS(ON)}$, low gate charge. It can be used in a wide variety of applications.

General Features

- V_{DS} 100V
- I_D (at $V_{GS} = 10V$) 5A
- $R_{DS(ON)}$ (at $V_{GS} = 10V$) < 130mΩ
- $R_{DS(ON)}$ (at $V_{GS} = 4.5V$) < 150mΩ
- 100% Avalanche Tested
- RoHS Compliant

Application

- Power switch
- DC/DC converters

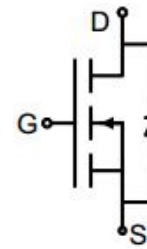

Schematic diagram

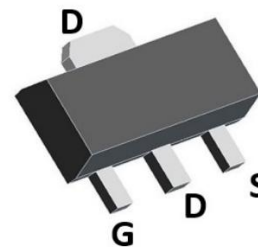

SOT-89

Ordering Information

Device	Package	Marking	Packaging
G1K3N10G	SOT-89	G1K3N10	1000pcs/Carton

Absolute Maximum Ratings $T_C = 25^\circ C$, unless otherwise noted

Parameter	Symbol	Value	Unit
Drain-Source Voltage	V_{DS}	100	V
Continuous Drain Current	I_D	5	A
Pulsed Drain Current (note1)	I_{DM}	20	A
Gate-Source Voltage	V_{GS}	± 20	V
Power Dissipation	P_D	1.5	W
Operating Junction and Storage Temperature Range	T_J, T_{stg}	-55 To 150	$^\circ C$

Thermal Resistance

Parameter	Symbol	Value	Unit
Thermal Resistance, Junction-to-Ambient	R_{thJA}	83	$^\circ C/W$

Specifications $T_J = 25^\circ\text{C}$, unless otherwise noted						
Parameter	Symbol	Test Conditions	Value			Unit
			Min.	Typ.	Max.	
Static Parameters						
Drain-Source Breakdown Voltage	$V_{(BR)DSS}$	$V_{GS} = 0V, I_D = 250\mu A$	100	--	--	V
Zero Gate Voltage Drain Current	I_{DSS}	$V_{DS} = 100V, V_{GS} = 0V$	--	--	1	μA
Gate-Source Leakage	I_{GSS}	$V_{GS} = \pm 20V$	--	--	± 100	nA
Gate-Source Threshold Voltage	$V_{GS(th)}$	$V_{DS} = V_{GS}, I_D = 250\mu A$	1	1.6	2	V
Drain-Source On-Resistance	$R_{DS(on)}$	$V_{GS} = 10V, I_D = 5A$	--	110	130	m Ω
		$V_{GS} = 4.5V, I_D = 5A$	--	120	150	
Forward Transconductance	g_{FS}	$V_{GS} = 5V, I_D = 5A$	--	7	--	S
Dynamic Parameters						
Input Capacitance	C_{iss}	$V_{GS} = 0V,$ $V_{DS} = 50V,$ $f = 1.0\text{MHz}$	--	644	--	pF
Output Capacitance	C_{oss}		--	25	--	
Reverse Transfer Capacitance	C_{rss}		--	14	--	
Total Gate Charge	Q_g	$V_{DD} = 50V,$ $I_D = 5A,$ $V_{GS} = 10V$	--	20	--	nC
Gate-Source Charge	Q_{gs}		--	2.1	--	
Gate-Drain Charge	Q_{gd}		--	3.3	--	
Turn-on Delay Time	$t_{d(on)}$	$V_{DD} = 50V,$ $I_D = 5A,$ $R_G = 3\Omega$	--	6	--	ns
Turn-on Rise Time	t_r		--	4	--	
Turn-off Delay Time	$t_{d(off)}$		--	20	--	
Turn-off Fall Time	t_f		--	4	--	
Drain-Source Body Diode Characteristics						
Continuous Body Diode Current	I_S	$T_C = 25^\circ\text{C}$	--	--	5	A
Body Diode Voltage	V_{SD}	$T_J = 25^\circ\text{C}, I_{SD} = 5A, V_{GS} = 0V$	--	--	1.2	V
Reverse Recovery Charge	Q_{rr}	$I_F = 5A, V_{GS} = 0V$ $di/dt=100A/us$	--	11	--	nC
Reverse Recovery Time	T_{rr}		--	22	--	ns

Notes

1. Repetitive Rating: Pulse width limited by maximum junction temperature
2. Identical low side and high side switch with identical R_G

Gate Charge Test Circuit



Switch Time Test Circuit



EAS Test Circuit



Typical Characteristics $T_J = 25^\circ\text{C}$, unless otherwise noted

Figure 1. Output Characteristics

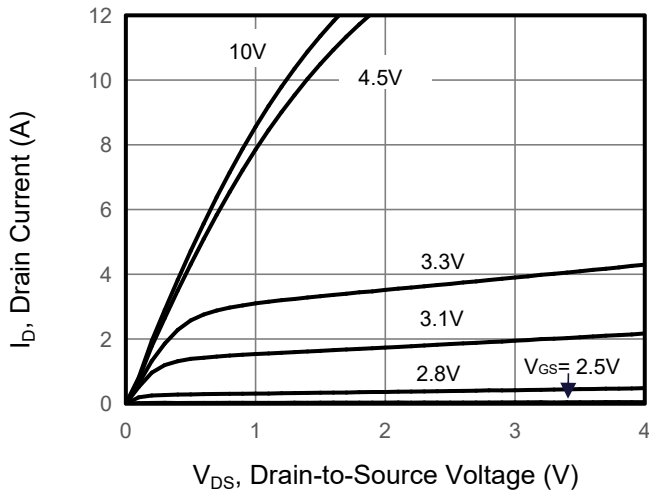

Figure 2. Transfer Characteristics

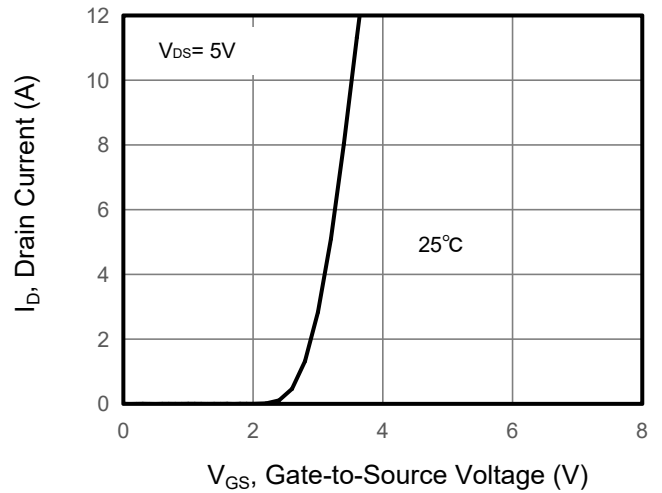

Figure 3. Drain Source On Resistance

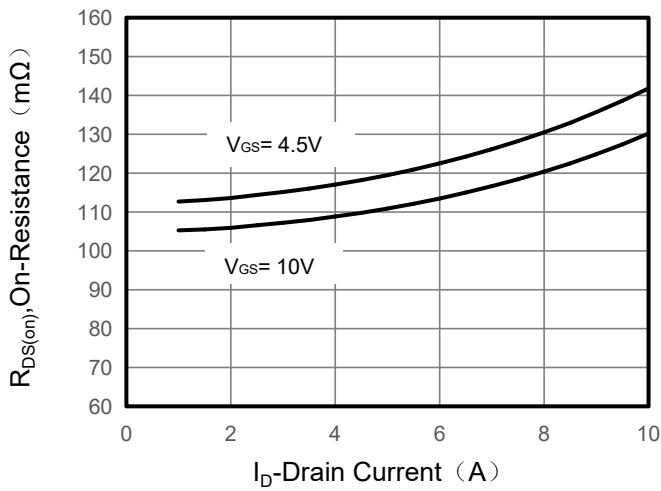

Figure 4. Gate Charge

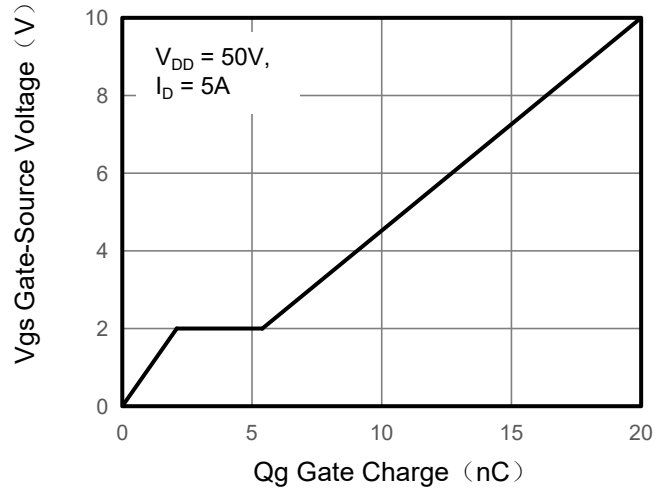

Figure 5. Capacitance

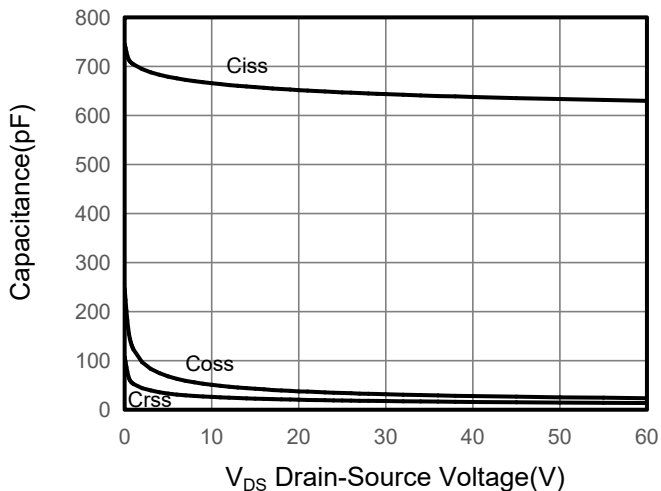
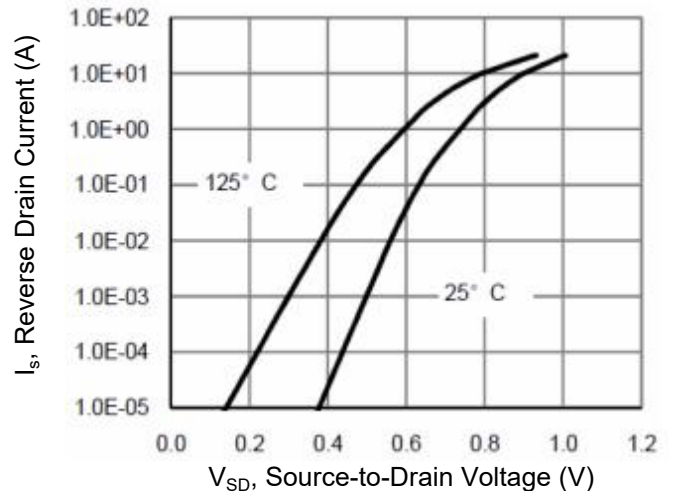

Figure 6. Source-Drain Diode Forward



Typical Characteristics $T_J = 25^\circ\text{C}$, unless otherwise noted

Figure 7. Drain-Source On-Resistance

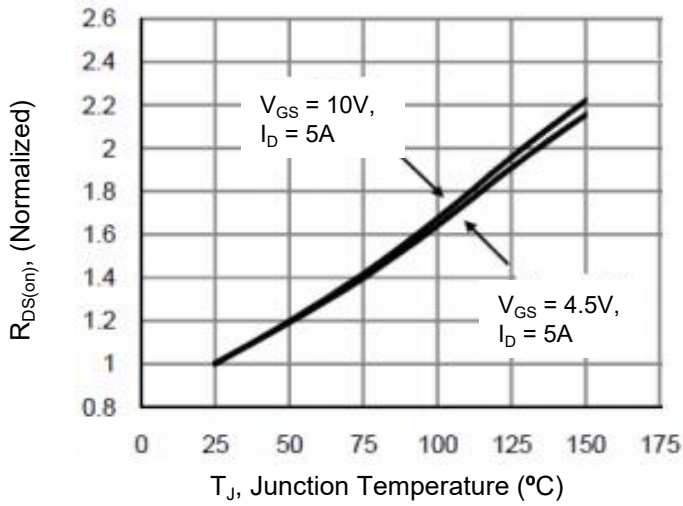

Figure 8. Safe Operation Area

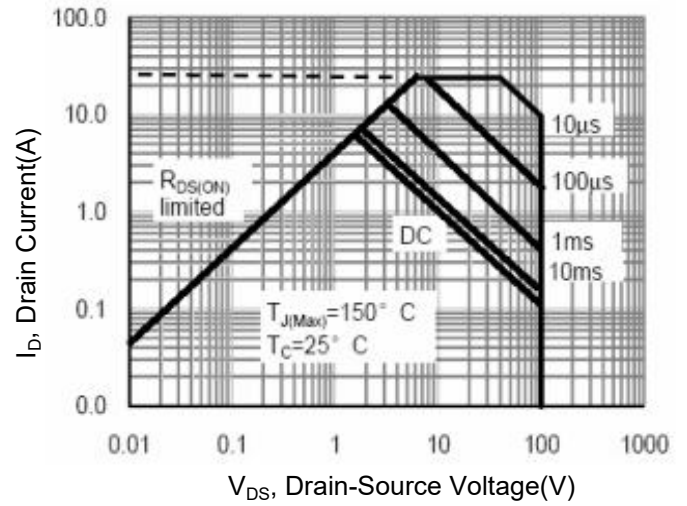
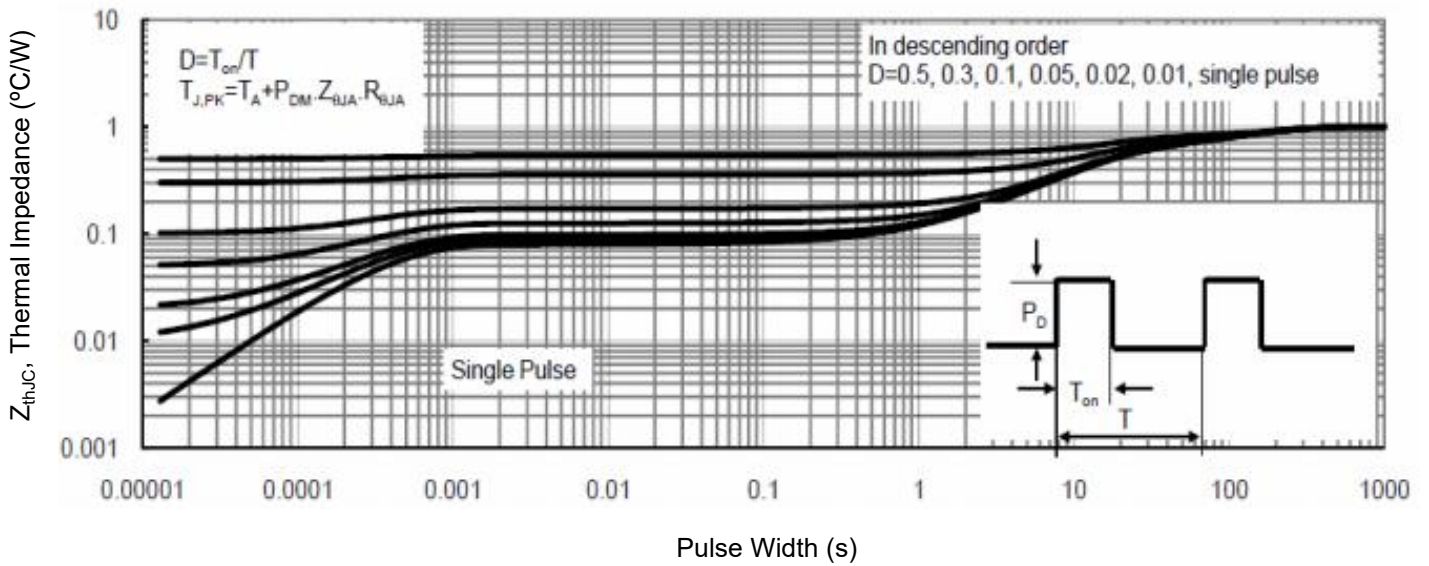
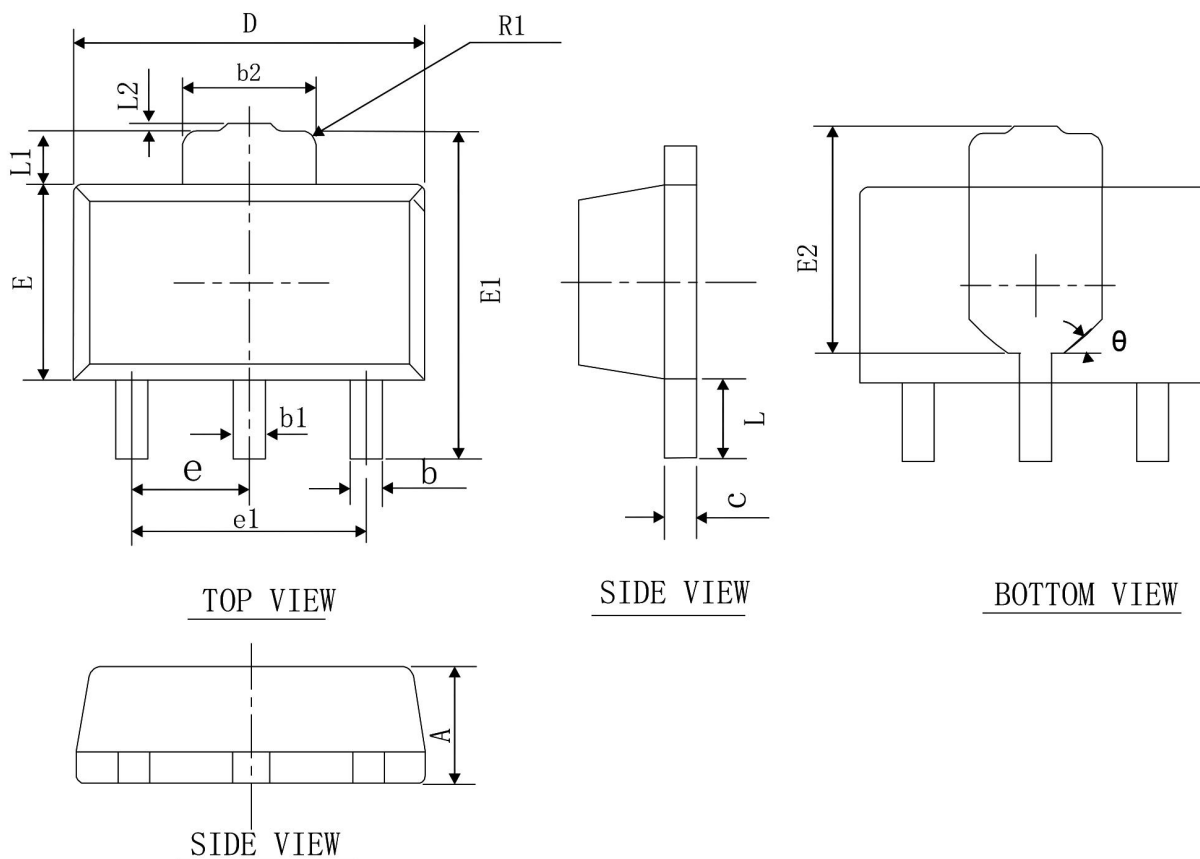

Figure 9. Normalized Maximum Transient Thermal Impedance



SOT-89 Package Information



SYMBOL	MIN	NOM	MAX
A	1.40	1.50	1.60
b	0.36	0.40	0.50
b1	0.44	0.48	0.58
b2	1.60	1.70	1.80
c	0.35	0.40	0.45
D	4.40	4.50	4.60
E	2.40	2.50	2.60
E1	4.00	4.20	4.40
E2	2.65	2.85	3.05
e1	2.80	3.00	3.20
L	0.90	1.00	1.10
L1	0.60	0.70	0.80
L2	0.075 REF		
R1	0.2 BSC		
θ	45° TYP		
e	1.5 BSC		