

# HD FL Series

Indoor / Outdoor Lighting



45W

## Features

- Dual heat dissipation of the lamp body.
- IP64 Waterproof Rating.
- Beam Angle: 180°
- Efficiency up to 125 lumens per watt
- Combined heat sink reserve gaps for more ventilation area.
- No fixture to replace, easy installation.
- Large heat sink, no fan.

## Input Voltage

- 100-277Vac 50/60Hz



## Advantages

- No lighting shadow, more luminance uniformity.
- Isolated aluminum heat sink for increased airflow.
- Suitable for totally enclosed fixtures.
- More than 15% LED compared with general corn bulb in market.

## Recommended Use

- Replacement lamps for outdoor pole/ arm - mounted decorative luminaires (Type B).



# HD FL Series

Indoor / Outdoor Lighting

| HD FL Series Corn Bulbs |                         |
|-------------------------|-------------------------|
| SKU #                   | 151009                  |
| MODEL #                 | BLT-CLW07-045WA-CA1-50K |
| CONSUMPTION             | 45W                     |
| LUMEN                   | 5400lm                  |

## Specifications

|                   |                     |
|-------------------|---------------------|
| COLOR TEMPERATURE | 5000K               |
| VIEWING ANGLE     | 180°                |
| INPUT VOLTAGE     | VAC 100-277 50/60Hz |
| POWER FACTOR      | >0.9                |
| BASE TYPE         | E39                 |
| WATERPROOF RATING | IP64                |
| LIFESPAN          | 50,000hrs           |

## Fixture Specifications

|               |              |
|---------------|--------------|
| LED BRAND     | Samsung      |
| LED TYPE      | SMD2835      |
| LED QUANTITY  | 126 PCS      |
| HOUSING       | PC +Aluminum |
| HOUSING COLOR | Any Colors   |
| COVER         | Clear        |

CORRELATED  
COLOR TEMPERATURE  
(CCT)

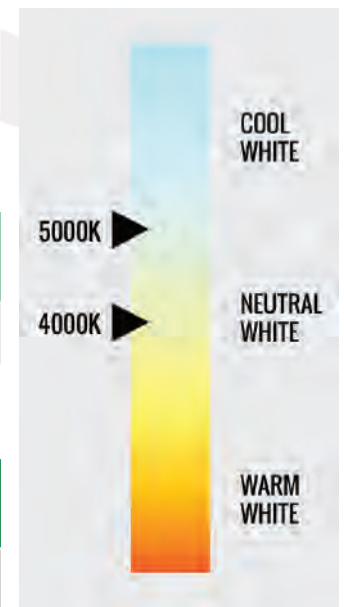

## Others

| OPERATING TEMPRATURE | APPLICATION      | CRI | BEAM ANGLE | DIMMABLE |
|----------------------|------------------|-----|------------|----------|
| -40°F TO 113°F       | Indoor / Outdoor | >80 | 180°       | No       |

## Warranty & Qualification

| WARRANTY       | UL LISTED | DLC |
|----------------|-----------|-----|
| 5 Year Limited | Yes       | Yes |

Due to continuous product improvement, information in this document is subject to change.

Revision Date: 12/04/2018

1939 Parker Ct Suite C Stone Mountain, GA 30087 | Phone: (866) 786-1117 |

[www.beyondledtechnology.com](http://www.beyondledtechnology.com)

# HD FL Series

## Indoor / Outdoor Lighting

### Package

| BOX TYPE  | SIZE                | QTY / CARTON | WEIGHT / CARTON | GROSS WEIGHT / CARTON |
|-----------|---------------------|--------------|-----------------|-----------------------|
| Inner Box | 12.2" x 4.7" x 4.7" | 1 PC         | 1.68 lbs        | 2.1 lbs               |
| Outer Box | 19.5" x 15" x 13"   | 12 PCS       | 20.3 lbs        | 26.9 lbs              |

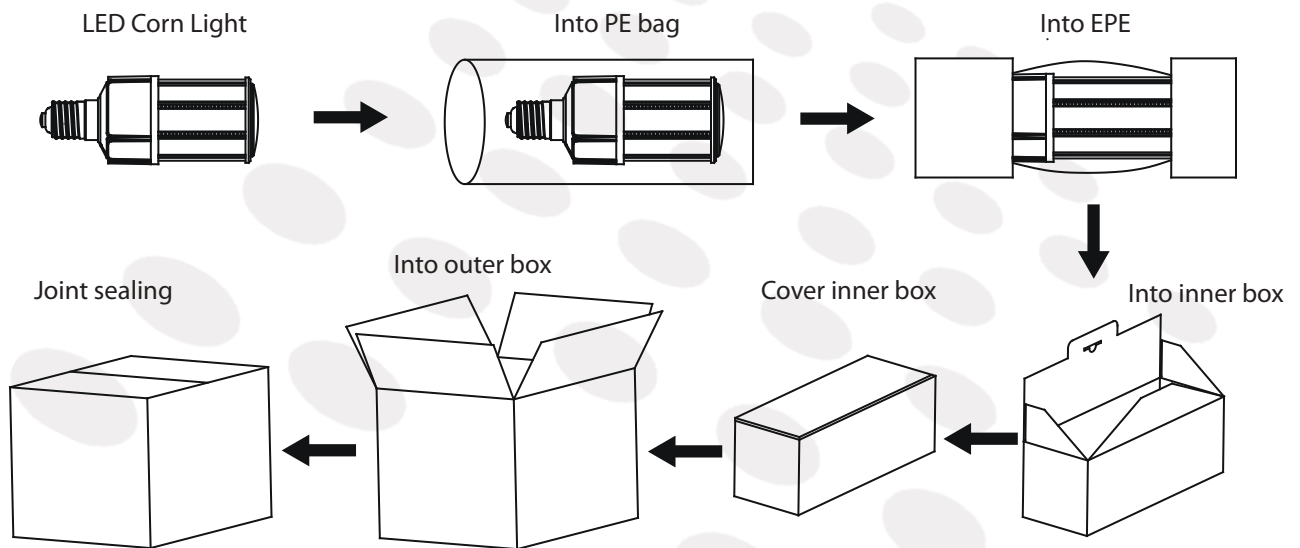

### Troubleshooting

- If the light flickers, turn off the power and turn it on again in 3 minutes. If this problem persists, please call agencies to assist.
- If item does not seem to be working, please recheck the connection.

### Notice for User

- Please turn off power before installation or changing assembly
- The input voltage and lamps should be matched. After connecting the power line, please make sure the wiring section is insulated.
- Make sure to remove or bypass the ballast in the fixtures before installing the lamps.
- Suitable for damp locations. Do not use with dimmers
- Suitable for use in enclosed luminaires, min. lamp compartment dimensions: 15.7" x 7.9" x 7.9" Inches.
- Licensed electrician installation ONLY.

### Dimensions

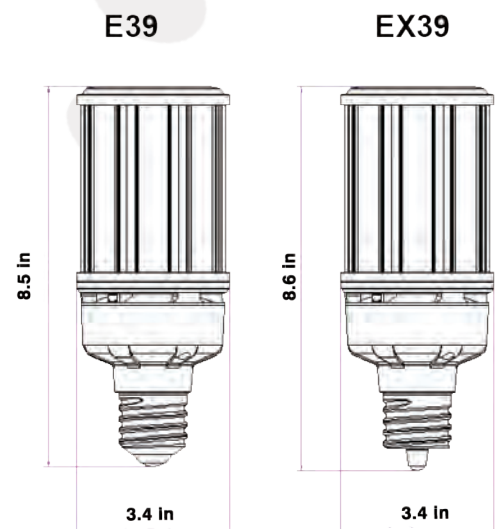

Due to continuous product improvement, information in this document is subject to change.

Revision Date: 12/04/2018

1939 Parker Ct Suite C Stone Mountain, GA 30087 | Phone: (866) 786-1117 |

[www.beyondledtechnology.com](http://www.beyondledtechnology.com)

# HD FL Series

Indoor / Outdoor Lighting

## Installation Guide

For safety, all power MUST be disconnected prior to removal of existing lamps and installation of LED Corn Bulb.

**WARNING:** Failure to disconnect power could result in serious injury or death. It is the end user's responsibility to consult a licensed electrician and check all local building codes before installation. Risk of fire. Fixtures are rated for use in 100-277Vac, 50-60HZ. Protected circuit and 90°C rated supply Risk of cut. The enclosed product may have sharp edges. Wear gloves to prevent cuts when handling, removing, installing, and maintaining.



Replace CFL

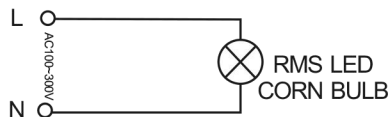
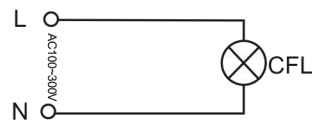

Replace HID

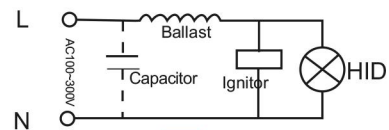

Inductive Ballast

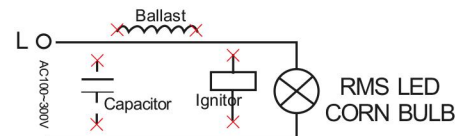

Due to continuous product improvement, information in this document is subject to change.

Revision Date: 01/16/2019

1939 Parker Ct Suite C Stone Mountain, GA 30087 | Phone: (866) 786-1117 |

[www.beyondledtechnology.com](http://www.beyondledtechnology.com)

# HD FL Series

Indoor / Outdoor Lighting

## Light Distribution Testing Parameters

| Photometric Results            |           |                                    |            |
|--------------------------------|-----------|------------------------------------|------------|
| <b>IES Classification</b>      | Type IV   | <b>Longitudinal Classification</b> | Short      |
| <b>Total Rated Lamp Lumens</b> | 5189.1 lm | <b>Measurement Flux</b>            | 5189.1 lm  |
| <b>Efficiency</b>              | 100%      | <b>Downward Ratio</b>              | 81%        |
| <b>Upward Ratio</b>            | 19%       | <b>Luminaire Efficacy Rating</b>   | 114.78     |
| <b>Central Intensity</b>       | 184.9 cd  | <b>Max Intensity</b>               | 1072.79 cd |
| <b>Pos of Max Intensity</b>    | H45 V70   |                                    |            |

\* The testing data comes from the product in luminaires.

Luminous Intensity Distribution Curve

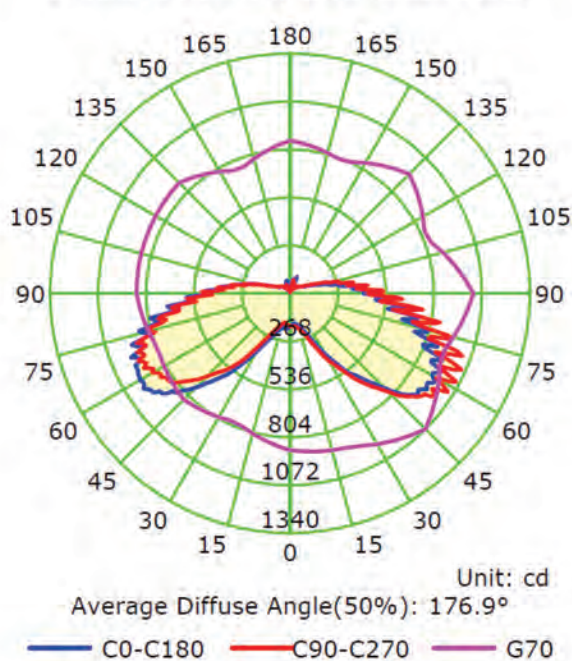

The Average Illuminance Effective Figure

