



MAX5974A Evaluation Kit

Evaluates: MAX5974A

General Description

The MAX5974A evaluation kit (EV kit) is a fully assembled and tested surface-mount circuit board featuring the MAX5974A active-clamped, spread-spectrum, current-mode PWM controller for Power-over-Ethernet (PoE) powered device (PD) applications. The EV kit is a compact and low-cost design used in Power-over-LAN (PoLAN) applications requiring DC power from an Ethernet network port for PDs such as IP phones, wireless access nodes, and security cameras.

The EV kit features a galvanically isolated 25W, 600kHz switching frequency forward DC-DC converter using the IC. The circuit achieves high efficiency up to 92% ($V_{IN} = +42V$) using a coupled-inductor forward DC-DC converter topology. The surface-mount transformer provides up to +1650V galvanic isolation for the output. The EV kit output voltage is configured for +5V and provides up to 4.7A load current.

The EV kit includes the MAX5969B IEEE® 802.3af/at-compliant network PD interface-controller IC, which provides PD detection signature, PD classification signature, in-rush current control, and undervoltage lockout (UVLO).

The EV kit circuit receives its power from IEEE 802.3af/at-compliant power-sourcing equipment (PSE). The PSE provides the required -30V to -57V DC power over an unshielded twisted-pair Ethernet network cable to the EV kit's RJ45 MagJack®. The EV kit features a 1 x 1Gb RJ45 MagJack and two full-bridge diodes for separating the DC power provided by an endspan or midspan Ethernet system.

The EV kit circuit can also be powered by a +37V to +57V wall-adaptor power source applied at the PWR+ and PWR- PCB pads. When a wall-adaptor power source is detected, it takes precedence over the PSE source, allowing the wall adapter to power the EV kit.

Warning: The EV kit is designed to operate with high voltages. Dangerous voltages are present on this EV kit and on equipment connected to it. Users who power up this EV kit or power the sources connected to it must be careful to follow safety procedures appropriately to work with high-voltage electrical equipment.

Under severe fault or failure conditions, this EV kit may dissipate large amounts of power that could result in the mechanical ejection of a component or of component debris at high velocity. Operate this kit with care to avoid possible personal injury.

IEEE is a registered service mark of the Institute of Electrical and Electronics Engineers, Inc.

MagJack is a registered trademark of Bel Fuse Inc.

Features

- ◆ IEEE 802.3af/at-Compliant PD Interface Circuit
- ◆ -30V to -57V Input Range
- ◆ Demonstrates an Isolated 23.5W Coupled-Inductor Forward DC-DC Converter
- ◆ 92% Efficiency (MAX5974A DC-DC Circuitry)
- ◆ Isolated +5V Output at 4.7A
- ◆ PD Detection and Configurable Classification Signatures
- ◆ 2-Event Classification or Wall-Adapter Detect Output
- ◆ In-Rush Current Limit of 180mA (max)
- ◆ Internal UVLO at +16V
- ◆ Evaluates Endspan and Midspan Ethernet Systems
- ◆ Simplified Wall-Adapter Interface
- ◆ Proven PCB Layout
- ◆ Fully Assembled and Tested

Ordering Information

PART	TYPE
MAX5974AEVKIT#	EV Kit

#Denotes RoHS compliant.



MAX5974A Evaluation Kit

Evaluates: MAX5974A

Component List

DESIGNATION	QTY	DESCRIPTION
C1	1	10pF $\pm 5\%$, 50V COG ceramic capacitor (0603) Murata GRM1885C1H100H
C2	1	0.1 μ F $\pm 10\%$, 100V X7R ceramic capacitor (1206) KEMET C1206C104K1RACTU
C3	1	0.056 μ F $\pm 10\%$, 16V X7R ceramic capacitor (0402) Murata GRM155R61C104K
C4	1	22 μ F $\pm 10\%$, 25V X7R ceramic capacitor (1210) Murata GRM32ER61E226K
C5	1	0.047 μ F $\pm 10\%$, 50V X7R ceramic capacitor (0603) Murata GRM188R71H473K
C6	1	1 μ F $\pm 10\%$, 100V X7R ceramic capacitor (1210) AVX 1210C105KAT9A
C7	1	33 μ F $\pm 20\%$, 63V aluminum electrolytic capacitor (8.3mm x 8.3mm) Panasonic EEE1JA330P
C8–C11	4	47 μ F $\pm 10\%$, 16V X5R ceramic capacitors (1210) Murata GRM32ER61C476K
C12	1	0.1 μ F $\pm 10\%$, 50V X7R ceramic capacitor (0603) Murata GRM188R71H104K
C13	1	0.1 μ F $\pm 10\%$, 100V X7S ceramic capacitor (0603) TDK C1608X7S2A104K
C14	1	0.01 μ F $\pm 10\%$, 25V X5R ceramic capacitor (0402) AVX 04023D103KAT2A
C15	1	0.047 μ F $\pm 10\%$, 16V X5R ceramic capacitor (0402) TDK C1005X7R1C473K
C16	1	1500pF $\pm 10\%$, 50V X7R ceramic capacitor (0402) Murata GRM155R71H152K
C17	1	0.01 μ F $\pm 10\%$, 250V X7R ceramic capacitor (1206) KEMET 12062C103KARACT4

DESIGNATION	QTY	DESCRIPTION
C18	1	2200pF $\pm 10\%$, 250V AC X7R ceramic capacitor (2220) Murata GA355QR7GF222KW0IL
C22	1	1000pF $\pm 10\%$, 1500V X7R ceramic capacitor (1210) AVX LD10SC102KAB1A
C24	1	330pF $\pm 10\%$, 50V X7R ceramic capacitor (0402) Murata GRM155R71H331K
D1, D2	2	200V, 1A bridge rectifiers (MiniDIP) Diodes Inc. HD01-T
D3	1	58V, 600W transient voltage suppressor (SMB) Diodes Inc. SMBJ58A (Top Mark: NG)
D4, D5, D8, D10	4	100mA, 80V diodes (SOD323) Diodes Inc. 1N4148WS
D7	1	100V, 2A Schottky diode (SMB) Diodes Inc. B2100-13-F
D11	01	Not installed, zener diode
GND, 5V	2	Binding posts
J1	1	Modular jack assembly, side entry, 8 position
N1, N2	2	25V, 20A n-channel MOSFETs (PowerPak, 8 SO) Vishay SiR412DP
N3	1	150V, 4.1A n-channel MOSFET (8 SO) Fairchild FDS86242
N4	1	150V, -0.42V p-channel MOSFET (6 SC70) Vishay Si1411DH
Q1	0	Not installed, transistor (SOT23)
Q2	1	30V, 100mA pnp transistor (SOT23)
R1, R8	2	30.1k Ω $\pm 1\%$ resistors (0603)
R2	1	69.8k Ω $\pm 1\%$ resistor (0603)
R3	1	54.9k Ω $\pm 1\%$ resistor (0402)
R4	1	30.9 Ω $\pm 1\%$ resistor (0805)
R5	1	59.0k Ω $\pm 1\%$ resistor (0603)
R6	1	16.9k Ω $\pm 1\%$ resistor (0402)

MAX5974A Evaluation Kit

Component List (continued)

DESIGNATION	QTY	DESCRIPTION
R7, R26	2	499Ω ±1% resistors (0402)
R9, R27	2	100kΩ ±1% resistors (0402)
R10	1	2kΩ ±1% resistor (0402)
R11	1	10kΩ ±1% resistor (0402)
R12, R13	2	10Ω ±5% resistors (0805)
R14	1	24.9kΩ ±1% resistor (0603)
R15	1	14.7kΩ ±1% resistor (0402)
R16	1	0Ω ±5% resistor (0402)
R17	0	Not installed, resistor (0402)
R18	1	4.02kΩ ±1% resistor (0402)
R19, R23	2	10Ω ±5% resistors (0603)
R20	1	10kΩ ±1% resistor (0603)
R21, R25	2	0.33Ω ±1%, 1/4 W resistors (1206)
R28	1	49.9kΩ ±1% resistor (0402)
R38, R39, R44, R45	0	Not installed, resistors (0603)
R40–R43	4	75Ω ±5% resistors (0603)
R46	1	0Ω ±5% resistor (0603)
R47	1	1MΩ ±5% resistor (0603)
R49	1	100Ω ±1% resistor (0402)

DESIGNATION	QTY	DESCRIPTION
R50	1	10Ω ±1% resistor (1206)
RJ45	1	RJ45 MagJack 1G-Ethernet, 802.3af/at standard Bel Fuse Inc. 0826-1X1T-GH-F
T1	1	26W forward transformer (EP10) Cooper Bussmann CTX03-18774
T2	1	Transformer (EP8) Cooper Bussmann CTX03-18775
TP1	1	Small red test point
TP2	1	Small black test point
U1	1	Active-clamp PWM controller (16 TQFN-EP) Maxim MAX5974AETE+ (Top Mark: AHY)
U2	1	IEEE802.3at-powered device interface controller (10 TDFN-EP) Maxim MAX5969BETB+
—	1	PCB: MAX5974A EVALUATION KIT

Evaluates: MAX5974A

Component Suppliers

SUPPLIER	PHONE	WEBSITE
AVX Corporation	843-946-0238	www.avxcorp.com
Bel Fuse Inc.	201-432-0463	www.belfuse.com
Cooper Bussmann	916-941-1117	www.cooperet.com
Diodes Incorporated	805-446-4800	www.diodes.com
Fairchild Semiconductor	888-522-5372	www.fairchildsemi.com
KEMET Corp.	864-963-6300	www.kemet.com
Murata Electronics North America, Inc.	770-436-1300	www.murata-northamerica.com
Panasonic Corp	800-344-2112	www.panasonic.com
TDK Corp.	847-803-6100	www.component.tdk.com
Vishay	402-563-6866	www.vishay.com

Note: Indicate that you are using the MAX5974A when contacting these component suppliers.

MAX5974A Evaluation Kit

Quick Start

Required Equipment

- MAX5974A EV kit
- IEEE 802.3af/at-compliant PSE and Category 5e Ethernet network cable
- -48V, 1A-capable DC power supply
- Voltmeter

Hardware Connections

The EV kit is fully assembled and tested. Follow the steps below to verify board operation. **Caution: Do not turn on the power supply until all connections are completed.**

- 1) Use one of the following methods to power the EV kit:
 - **If network connectivity is required:** Connect a Category 5e Ethernet network cable from the EV kit input port RJ45 MagJack connector (RJ45) to the corresponding PSE Ethernet LAN connection to provide power to the EV kit. A modular RJ45 jack (J1) provides an interface with the Ethernet data signals only.
 - **If network connectivity is not required:** Connect a -48V DC power supply between the VDD and VSS pads on the EV kit. Connect the power-supply positive terminal to the VDD pad and the negative terminal to the VSS pad.
- 2) Activate the PSE power supply or turn on the external DC power supply.
- 3) Using a voltmeter, verify that the EV kit provides approximately +5V across the +5V and GND PCB pads. GND is galvanically isolated from the EV kit's input VDD and VSS pads.

Detailed Description of Hardware

The MAX5974A EV kit is a fully assembled and tested surface-mount circuit board that evaluates the MAX5974A active-clamped, spread-spectrum, current-mode PWM controller. The EV kit features a powered Ethernet port, a data-only Ethernet port, and a MAX5969B IEEE 802.3af/at-compliant network PD interface-controller IC.

The EV kit is a galvanically isolated 25W DC-DC converter using the active-clamped, current-mode PWM controller in a forward, coupled-inductor feedback topology. The EV kit receives power from an IEEE 802.3af/at-compliant PSE and a UTP cable connected to the EV kit's RJ45 MagJack. The EV kit uses a 1 x 1Gb RJ45 MagJack and two diode-bridge power rectifiers (D1, D2) to separate the -57V DC power sent by the PSE. The EV kit accepts power from an endspan or midspan PSE network configuration. The EV kit also provides an RJ45 jack (J1) for interfacing to the Ethernet data signals. PCB pads VDD and VSS are available for powering the EV kit if network connectivity is not required.

The EV kit output voltage is configured for +5V and provides up to 4.7A output current while achieving up to 92% efficiency. Transformer T1 provides up to +1650V galvanic isolation for the output. Transformer T2 is used for providing the operating voltage at the device's IN input and for coupled-inductor feedback control for setting the output voltage using resistors R3, R11, and R49. Current-sense resistors R21 and R25 limit the peak current through transistor N3 and primary transformer T1. PCB pad D11 is available for clamping the IC IN input when driving the EN input using an external source. Capacitor C17 and transistor N4 form a clamping network that protects transformer T1 against saturation, due to reverse current, by monitoring the voltage across the device's CS input during auxiliary driver N4's off time.

The EV kit also demonstrates the full PD functionality of the device, such as PD detection signature, PD classification signature, in-rush current control, and UVLO. Resistors R14 and R4 set the PD detection signature and the PD classification signature, respectively.

The EV kit circuit accepts power from a wall-adaptor DC power source. When a +37V to +57V wall-adaptor power source is applied at the PWR+ and PWR- PCB pads, it takes precedence over the PSE source, allowing the wall adapter to power the EV kit circuit. When applying a valid voltage source between the PWR+ and PWR- PCB pads, the MAX5969B's internal isolation switch disconnects VSS from RTN, which allows the wall adapter to supply power to the EV kit.

MAX5974A Evaluation Kit

PD Classification Signature

The EV kit is configured for a Class 4 (12.95W to 25.5W) PD classification by resistor R4. To reconfigure the PD classification, replace surface-mount 0805 resistor R4. Table 1 lists the PD classification options.

Wall-Adapter Power Source (PWR+, PWR-)

The EV kit can also accept power from a wall-adapter DC power source applied at the PWR+ and PWR- PCB pads. The wall-adapter power-source operating-voltage range must be within +37V to +57V for the EV kit.

When the wall-adapter power source is above +30V, it takes precedence over the PSE source. Once the wall-adapter power source is detected, the MAX5969B's internal isolation switch disconnects VSS from RTN. The wall-adapter power is supplied to VDD (through diode D7) and RTN. Once it takes over, the classification process is disabled. Resistors R27 and R28 are available for adjusting the EV kit wall-adapter voltage for disabling the PSE source.

When the wall-adapter power source is below +21V, the PSE provides power through the device's RTN. Diode D7 prevents the PSE from back-driving the wall-adapter power source when it is below +7V.

Ethernet Data-Signal Interfacing

The EV kit features a modular RJ45 jack (J1) to interface with the Ethernet data signals. J1 is provided for interfacing the EV kit with the Ethernet data signals only. Refer to the RJ45 MagJack data sheet on the Bel Fuse website prior to interfacing the EV kit's J1 modular RJ45 jack with the Ethernet data signals.

Table 1. PD Classification Signature Selection

CLASS	MAXIMUM POWER USED BY PD (W)	RESISTOR R4 (Ω)
0	0.44 to 12.95	615
1	0.44 to 3.84	117
2	3.84 to 6.49	66.5
3	6.49 to 12.95	43.7
4	12.95 to 25.5	30.9
5	> 25.5	22.6

Evaluates: MAX5974A

MAX5974A Evaluation Kit

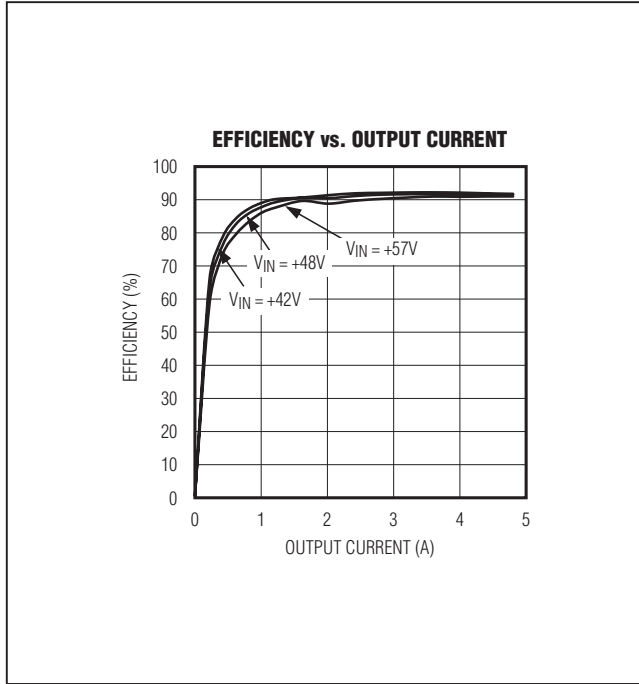

Figure 1. MAX5974A EV Kit Efficiency vs. Output ($V_{IN} = +42V$, $+48V$, and $+57V$)

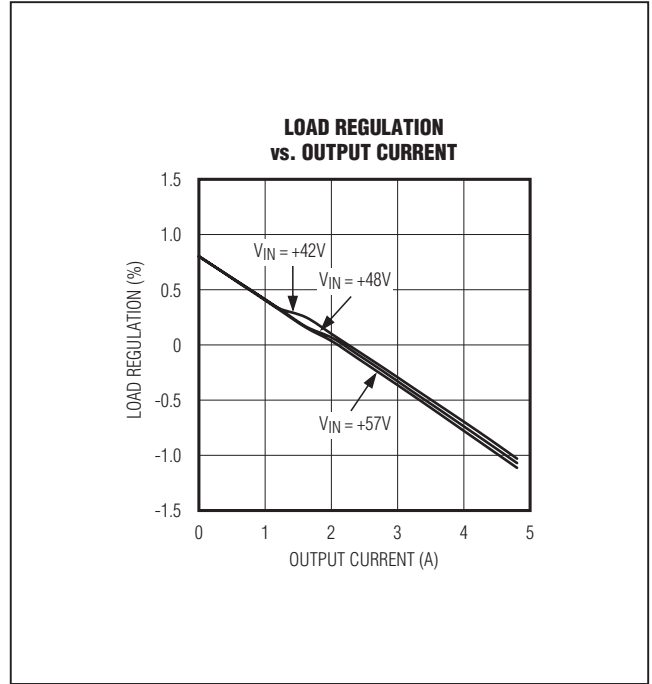

Figure 2. MAX5974A EV Kit Load Regulation vs. Output Current ($V_{IN} = +42V$, $+48V$, and $+57V$)

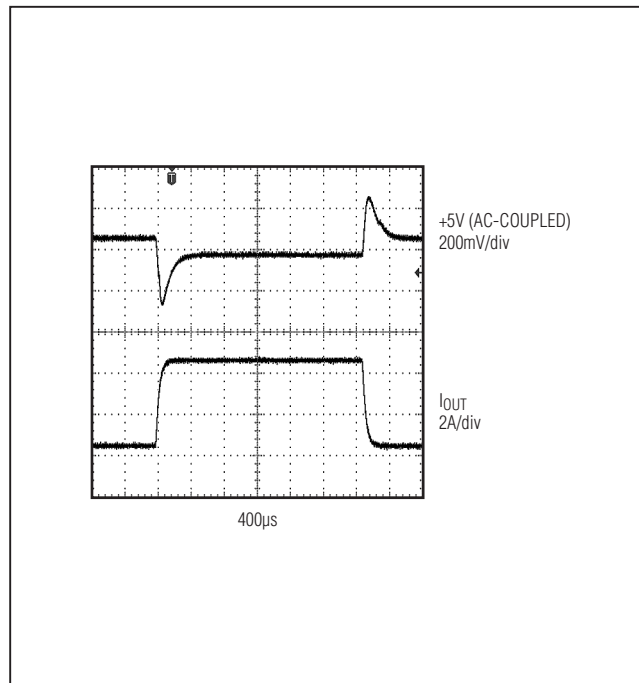

Figure 3. MAX5974A EV Kit Load Transient ($V_{IN} = +57V$)

MAX5974A Evaluation Kit

Evaluates: MAX5974A

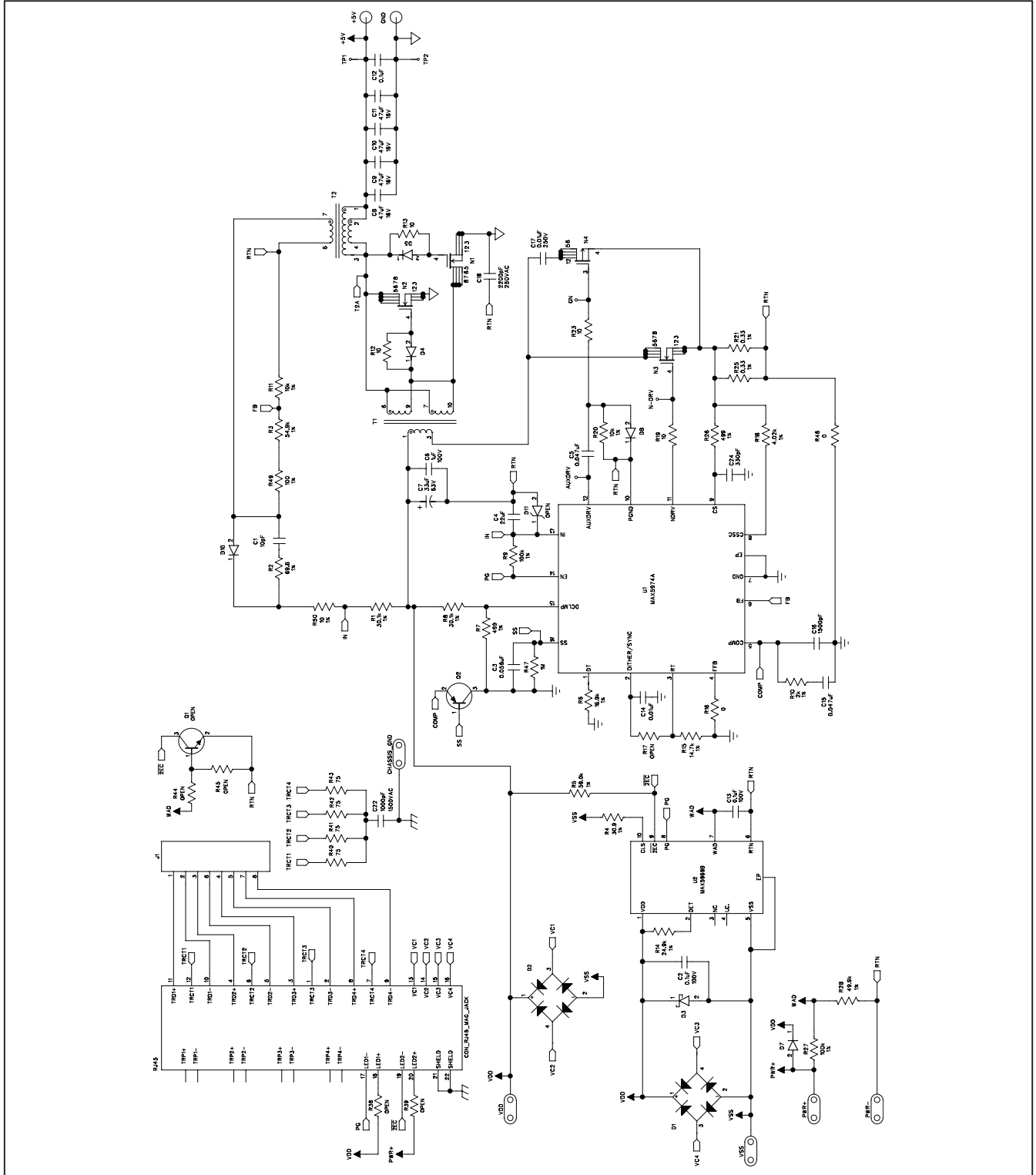

Figure 4. MAX5974A EV Kit Schematic

MAX5974A Evaluation Kit

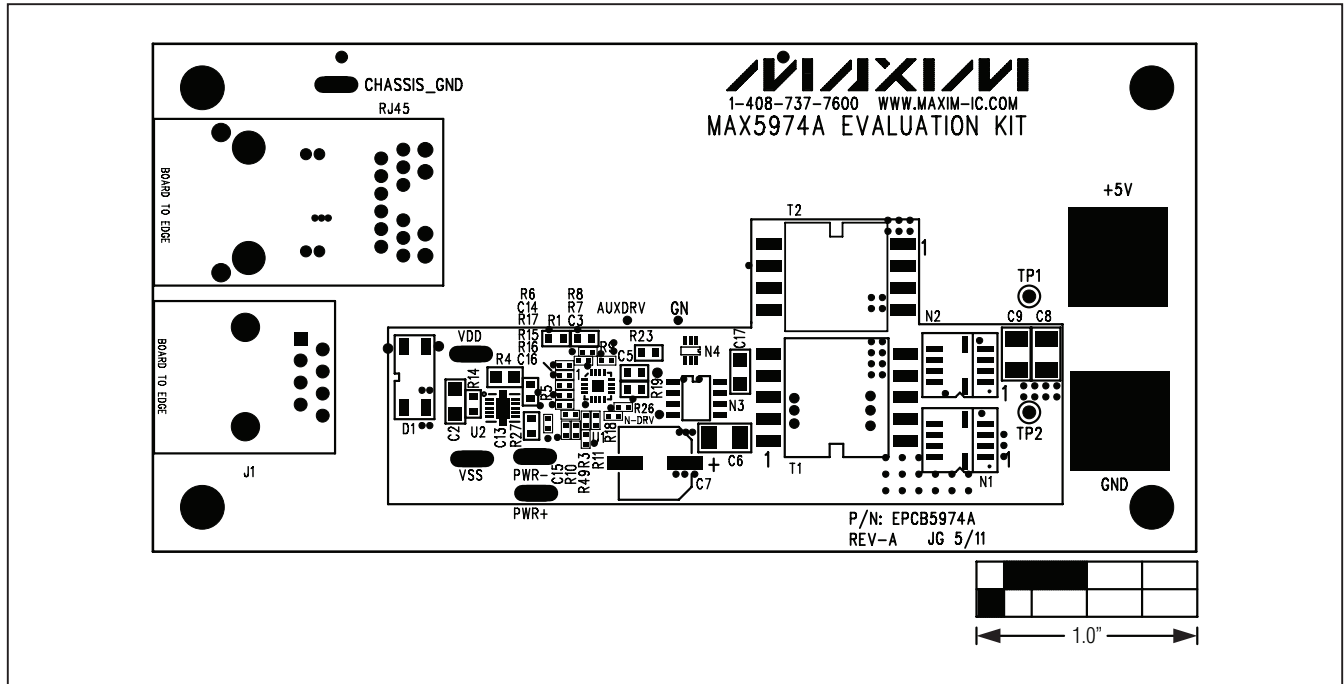

Figure 5. MAX5974A EV Kit Component Placement Guide—Component Side

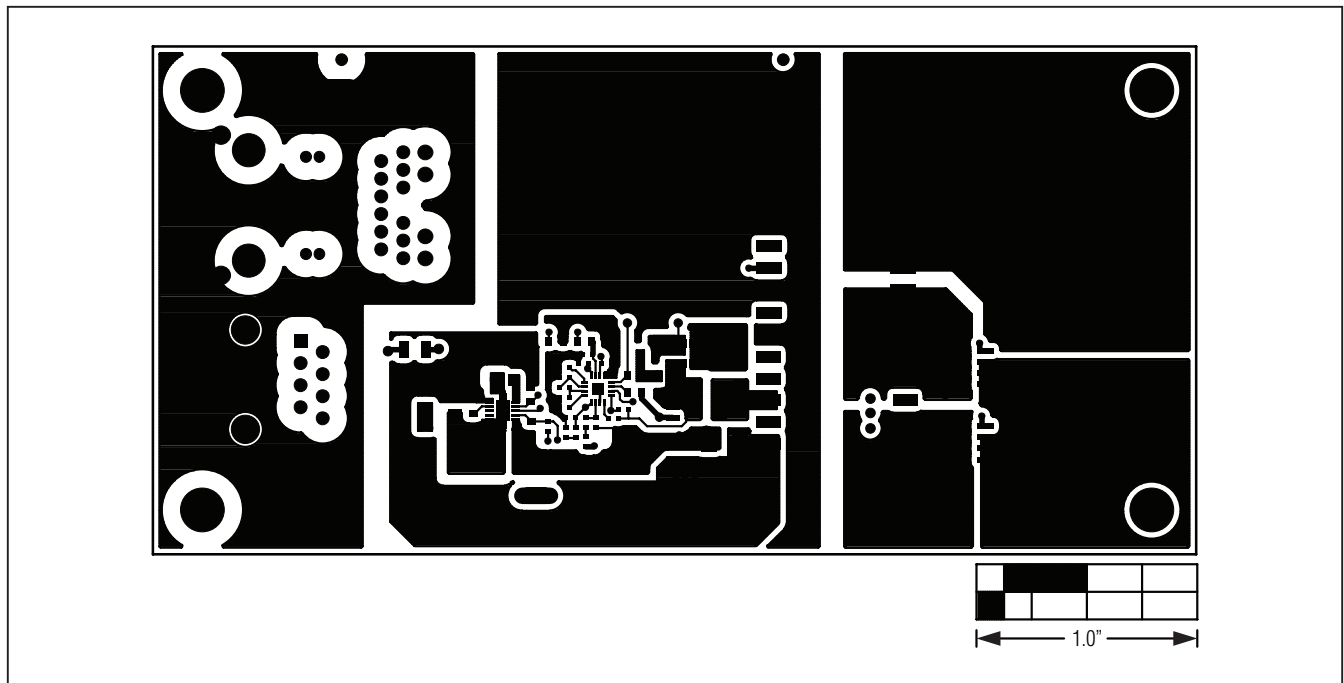

Figure 6. MAX5974A EV Kit PCB Layout—Component Side

MAX5974A Evaluation Kit

Evaluates: MAX5974A

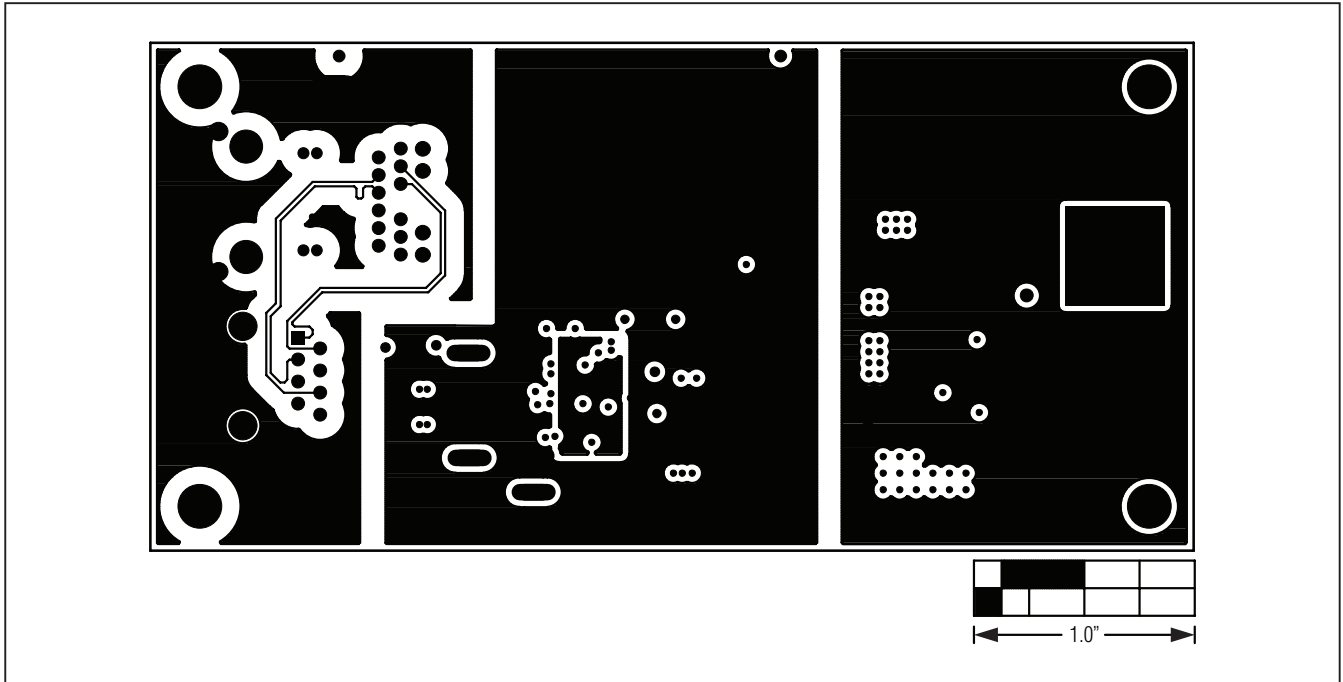

Figure 7. MAX5974A EV Kit PCB Layout—GND Layer 2

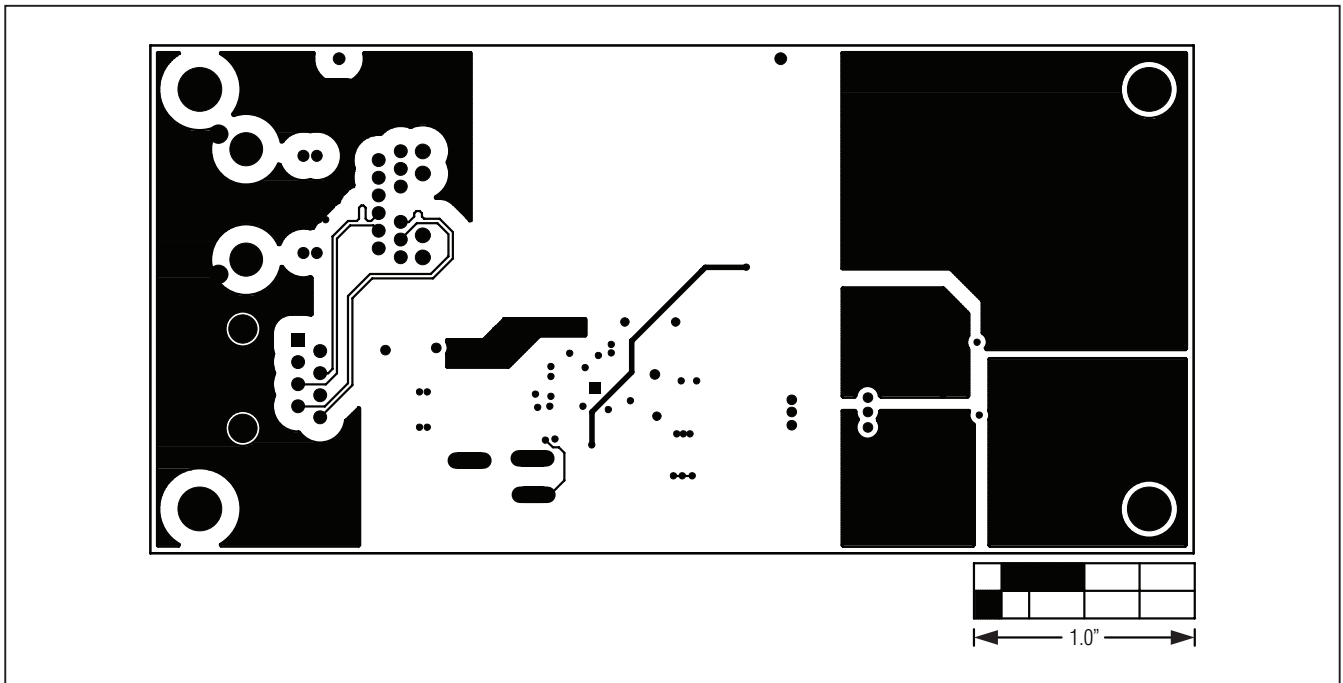

Figure 8. MAX5974A EV Kit PCB Layout—Signal Layer 3

MAX5974A Evaluation Kit

Evaluates: MAX5974A

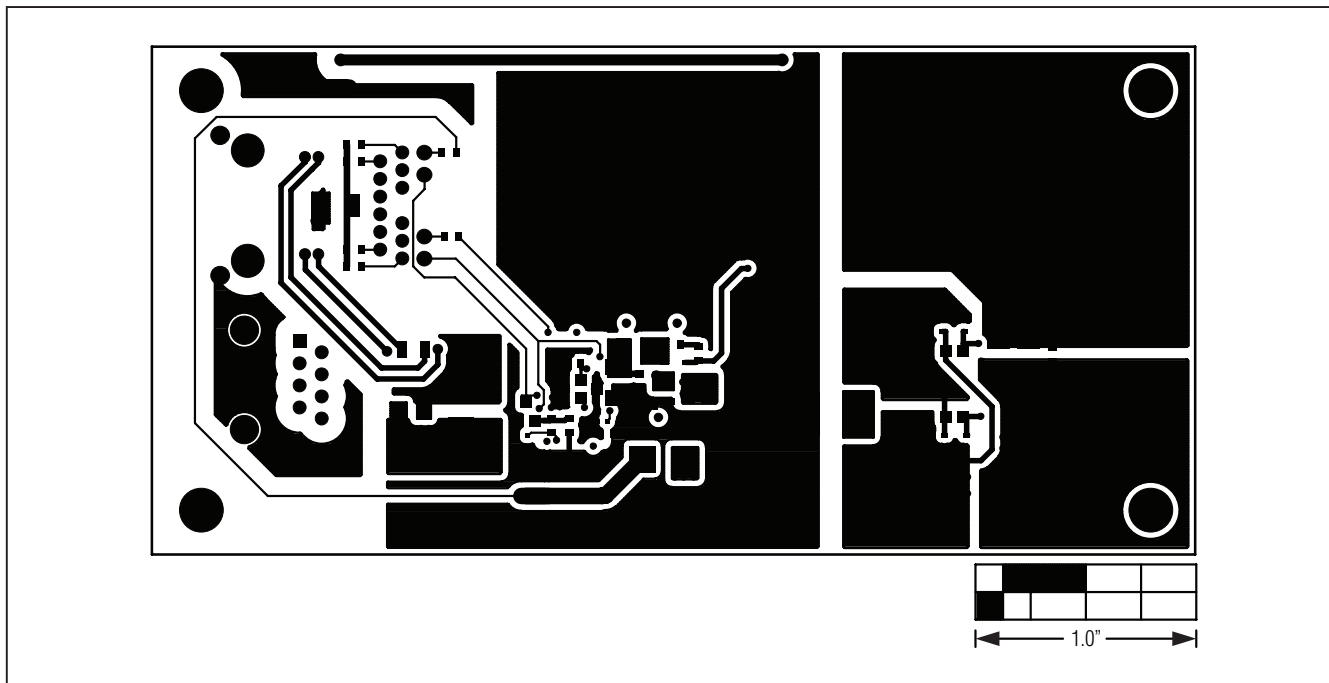

Figure 9. MAX5974A EV Kit PCB Layout—Solder Side

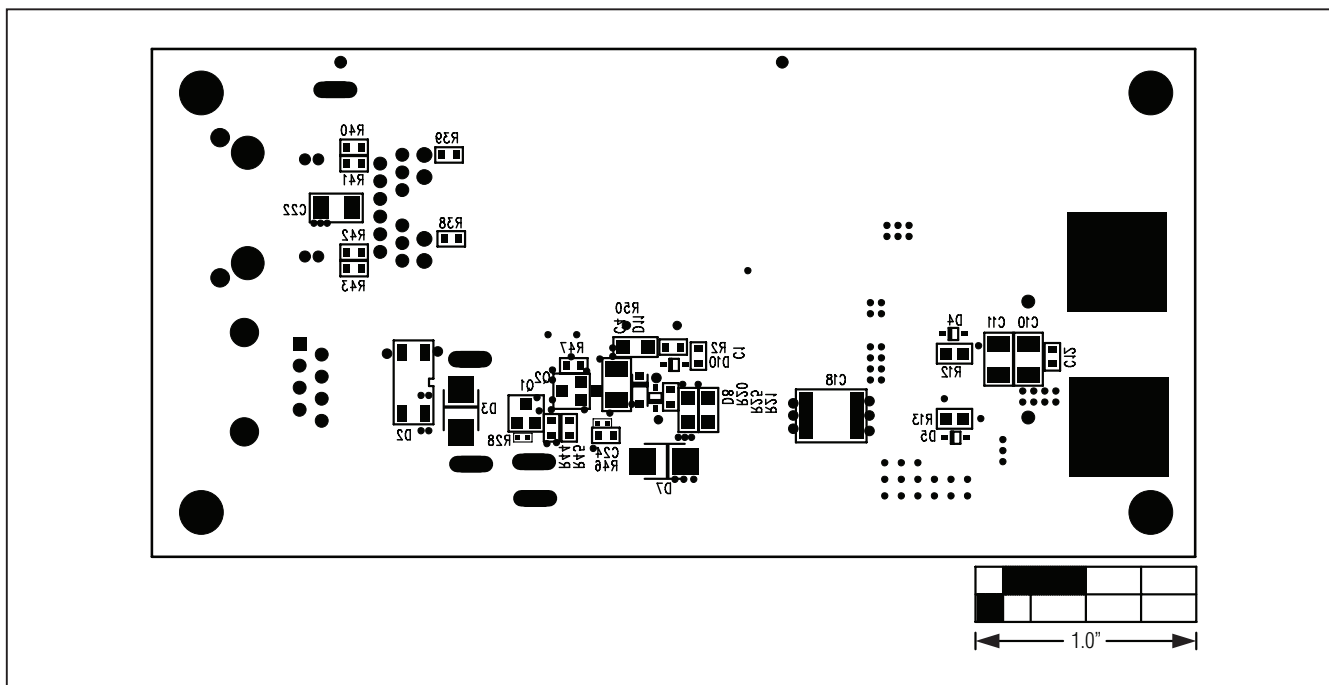

Figure 10. MAX5974A EV Kit Component Placement Guide—Solder Side

MAX5974A Evaluation Kit

Revision History

REVISION NUMBER	REVISION DATE	DESCRIPTION	PAGES CHANGED
0	5/11	Initial release	—

Evaluates: MAX5974A

Maxim cannot assume responsibility for use of any circuitry other than circuitry entirely embodied in a Maxim product. No circuit patent licenses are implied. Maxim reserves the right to change the circuitry and specifications without notice at any time.

Maxim Integrated Products, 120 San Gabriel Drive, Sunnyvale, CA 94086 408-737-7600 _____ 11