

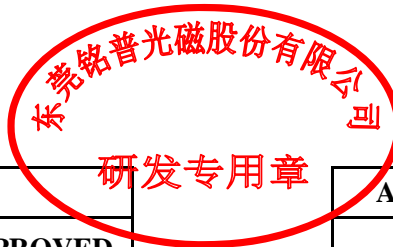



Product Specification for Approval

WE ARE PLEASED IN SUBMITTING OUR SAMPLES WITH SPECIFICATION TO YOU FOR APPROVAL.

CUSTOMER	:		
DESCRIPTION	:	100/1000 BASE-T TRANSFORMER	
MNC P/N	:	G2405CG	
VERSION	:	A0	
CUSTOMER P/N	:		
ISSUED DATE	:	2020/04/27	
PHOTO OF PRODUCT	:		
WEIGHT	:		1.48g
MADE IN	:		CHINA



APPROVED BY MNC			APPROVED BY CUSTOMER
PREPARED BY  研发部 2020-04-27 符晶晶	CHECKED BY  研发部 2020-04-27 肖明华	APPROVED BY  研发部 2020-04-27 何校民	SIGNATURE OR STAMP

1. PLEASE SEND BACK US A COPY OF THE SPECIFICATION WITH YOUR STAMP OR SIGNATURE ONCE THE SAMPLES APPROVED.
2. IT WILL BE DEEMED THE SAMPLES TO BE APPROVED IF NO FEEDBACK.

东莞铭普光磁股份有限公司
 Add: Shipai Town, Dongguan City, Guangdong Province, China

TEL: +86-769-86921000
 FAX: +86-769-81701563

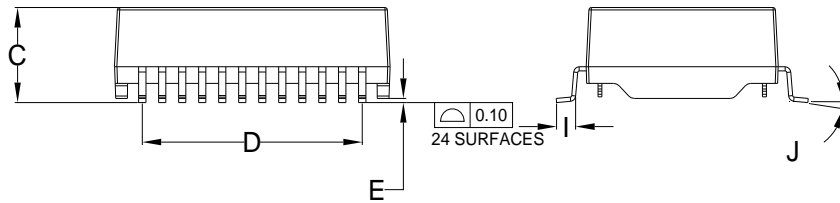
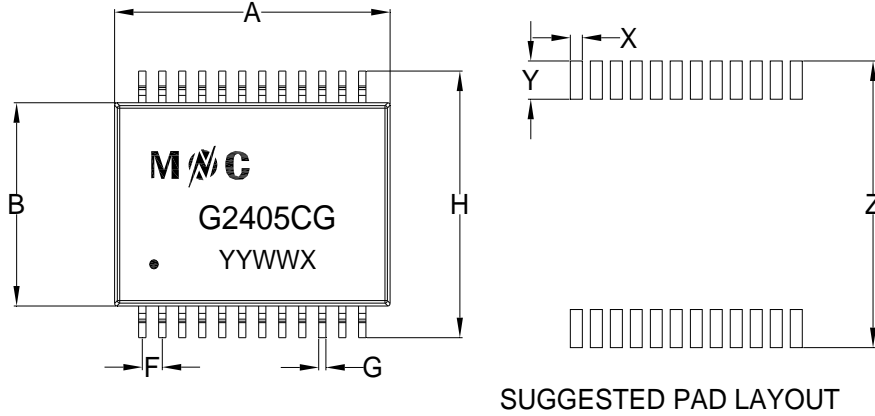
SPECIFICATION
Part No. G2405CG
A. MECHANICAL :

Note: Laser printing marking

YY	WW	X	
			Production line code
			(A to Z)
			Week
			Year

1. UNITS: mm/inch.
2. UNLESS OTHERWISE SPECIFIED ALL TOLERANCES ARE: TYPICAL
3. PIN LENGTH DON'T INCLUDE SOLDER POINT

DIM	MILLIMETERS			INCHES		
	MIN	NOM	MAX	MIN	NOM	MAX
A	17.00	17.50	18.00	0.669	0.689	0.709
B	11.70	12.20	12.70	0.461	0.480	0.500
C	/	/	6.20	/	/	0.244
D	13.47	13.97	14.47	0.530	0.550	0.570
E	0.10	0.25	0.40	0.004	0.010	0.016
F	1.17	1.27	1.37	0.046	0.050	0.054
G	0.36	0.46	0.56	0.014	0.018	0.022
H	15.50	16.00	16.50	0.610	0.630	0.650
I	/	1.24	/	/	0.049	/
J	0°	/	8°	0°	/	8°
X	/	0.76	/	/	0.030	/
Y	/	2.29	/	/	0.090	/
Z	/	17.20	/	/	0.677	/

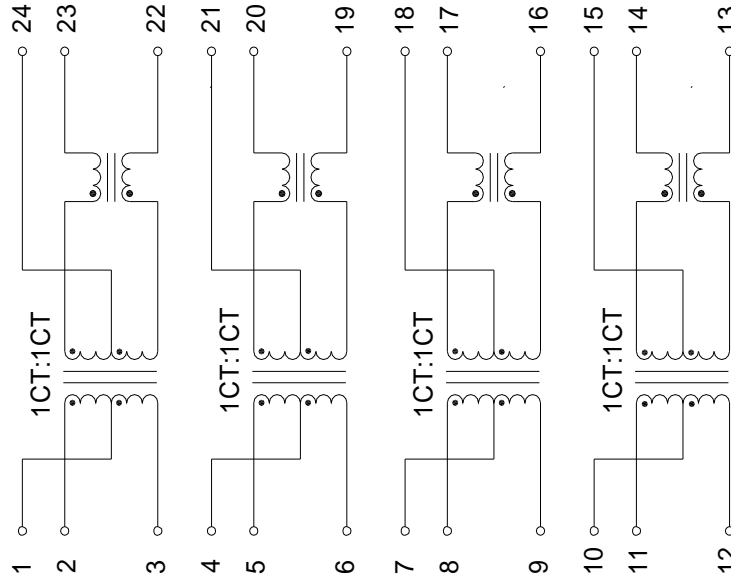
SPECIFICATION
Part No. G2405CG
B. SCHEMATIC :

C. ELECTRICAL SPECIFICATION @25°C

ITEM	SPECIFICATION	TEST CONDITION	TEST EQUIPMENT
INDUCTANCE :	350uH MIN.	100KHz 0.2V 8mA DC Bias	TH2819XB OR EQU.
LEAKAGE INDUCTANCE :	0.50uH MAX.	100KHz 0.2V	TH2819XB OR EQU.
INTERWINDING CAPACITANCE :	25pF TYP.	100KHz 0.2V	TH2819XB OR EQU.
DC RESISTANCE :	1.2Ω MAX.	AT 25 °C	TOS 8020 OR EQU.
TURNS RATIO :	1CT:1CT±5%		TH2819XB OR EQU.
POLARITY :	2-23,5-20,8-17,11-14 IN-PHASE		
INSERTION LOSS :	-1.1dB MAX.	0.5-100 MHz	E5061A OR EQU.
RETURN LOSS :	-18dB MIN.	0.5-40 MHz	E5061A OR EQU.
	-12+20log(f/80)dB MIN.	40.1-100 MHz	
CROSS TALK :	-35dB MIN.	0.5-40 MHz	E5061A OR EQU.
	-33+20*log(f/50)dB MIN.	40.1-100 MHz	
CMRR :	-30dB MIN.	0.5-100 MHz	E5061A OR EQU.
ISOLATION HI-POT :PRI TO SEC	1500VAC	1mA,60S	7152AB OR EQU.
	1650VAC	1mA,6S	
OPERATING TEMPERATURE	0°C TO 70°C		

PACKAGE

Part No. G2405CG

D. PACKING:

a. PACKAGING AS BELOW (ONLY FOR A REFERENCE):

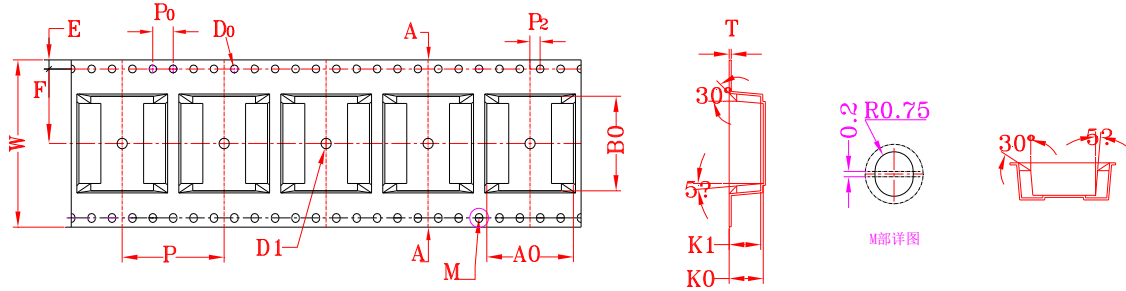

ITEM	W	A ₀	B ₀	K ₀	K ₁	P	F	E	D ₀	D ₁	P ₀	P ₂	T
DIM	32.00 ^{+0.30} _{-0.30}	17.0 ^{+0.10} _{-0.10}	18.10 ^{+0.10} _{-0.10}	6.70 ^{+0.10} _{-0.10}	6.20 ^{+0.10} _{-0.10}	20.00 ^{+0.10} _{-0.10}	14.2 ^{+0.10} _{-0.10}	1.75 ^{+0.10} _{-0.10}	1.50 ^{+0.10} _{-0.10}	2.00 ^{+0.10} _{-0.10}	4.00 ^{+0.10} _{-0.10}	2.00 ^{+0.10} _{-0.10}	0.40 ^{+0.05} _{-0.05}
ALTERNATE													

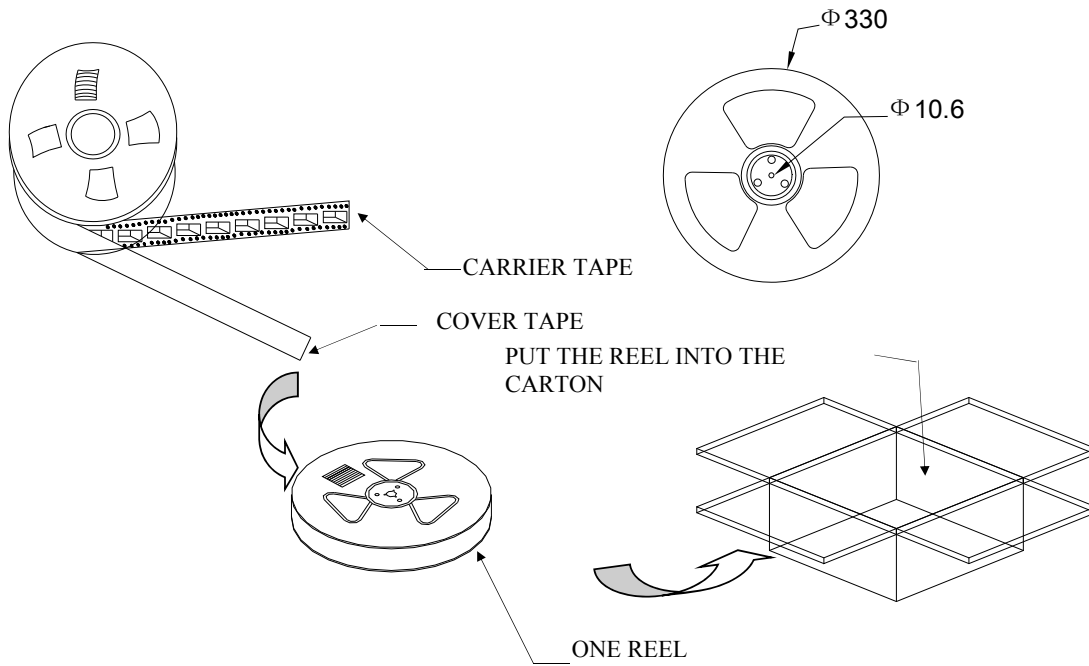

b. Q'TY:

400 PCS PER REEL
6 REELS PER CARTON
2400 PCS PER CARTON

c. LABEL:



REMARK:

ABOVE PACKING IS FOR YOUR REFERENCE ONLY, WHICH MIGHT BE CHANGED WITHOUT NOTICE.

MATERIAL LIST
Part No. G2405CG
E.BOM

MATERIAL LIST					
NO.	ITEM	MATERIAL	RATING	SUPPLIER OF MATERIAL	UL
1	CORE	Mn-Zn	-----	YEAN SHING	N/A
			-----	ZHONGSHAN CRC ELECTRONICS FACTORY	N/A
		Ni-Zn	-----	YEAN SHING	N/A
			-----	ZHONGSHAN CRC ELECTRONICS FACTORY	N/A
2	COPPER WIRE	QPN180	180°C	ZHUHAI SUNTEK WIRE CO.,LTD	E234867
		Polysol 180	180°C	ELEKTRISOLA(MALAYSIA) SDN.BHD.	E258243
3	CASE	WH-9100	V-0	WAH HONG INDUSTRIAL CORP	E150608
4	PIN	C5191	-----	SHENZHEN MINGSCHIN INDUSTRIAL MATERIAL CO.,LTD	N/A

RECOMMENDED SOLDERING PROFILE

Part No. G2405CG

a. RECOMMENDED REFLOW SOLDERING PROFILE:

below content is only for your reference

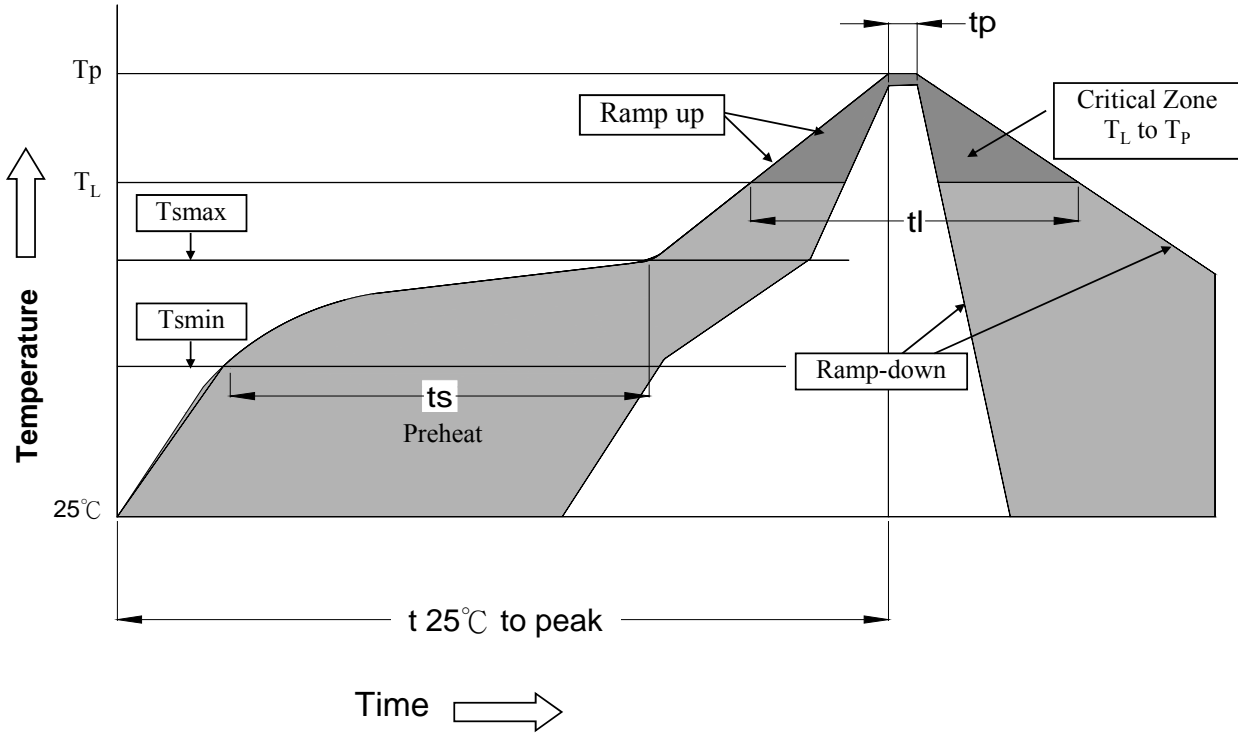

$T_L = 217^\circ\text{C}$

$T_P = 245^\circ\text{C}$

$t_s = 60-180\text{s}$ $T_{s\text{ max}} = 200^\circ\text{C}$ $T_{s\text{ min}} = 150^\circ\text{C}$

$t_l = 60-150\text{s}$ $t_p = 20-40\text{s}$ $T_{25^\circ\text{C to peak}} = 8\text{min max}$

Ramp up rate = 3°C/s max

Ramp down rate = 6°C/s max

*RoHS Compliant

*Solder Paste SAC 305 Sn 96.5/Ag 3.0/Cu 0.5

*Silkscreen thickness: 0.15mm Min

b. MOISTURE SENSITIVE LEVEL:

b.1. LEVEL: 1

b.2. SHELF LIFE: UNLIMITED

b.3. STORAGE CONDITION: $\leq 30^\circ\text{C}/85\% \text{ RH}$