

Data sheet | Item number: 890-3105

Socket for PCBs; straight; 5-pole; Cod. I; blue

www.wago.com/890-3105

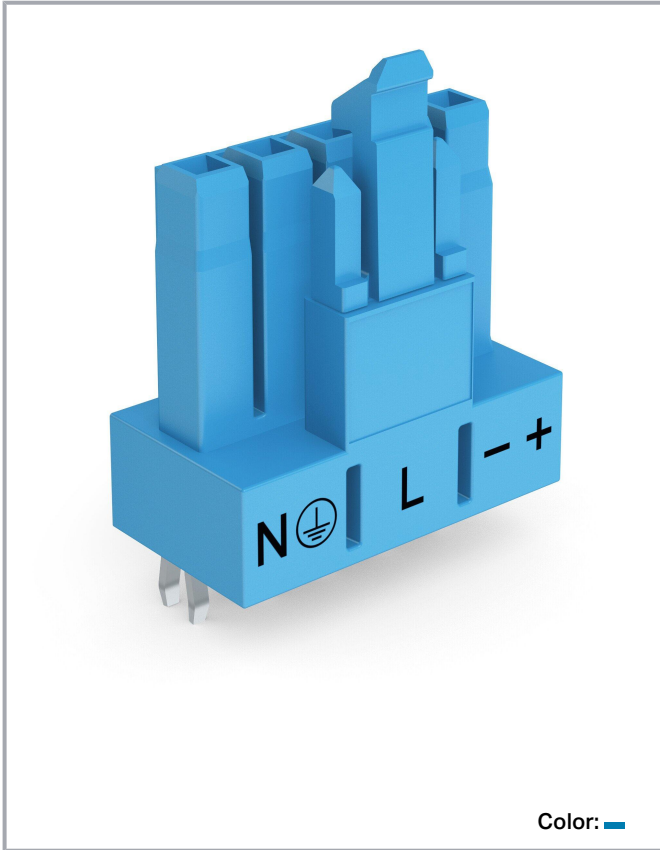

Color: ■

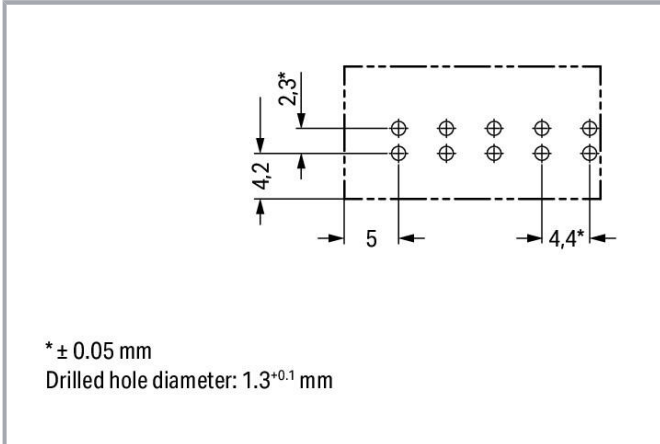
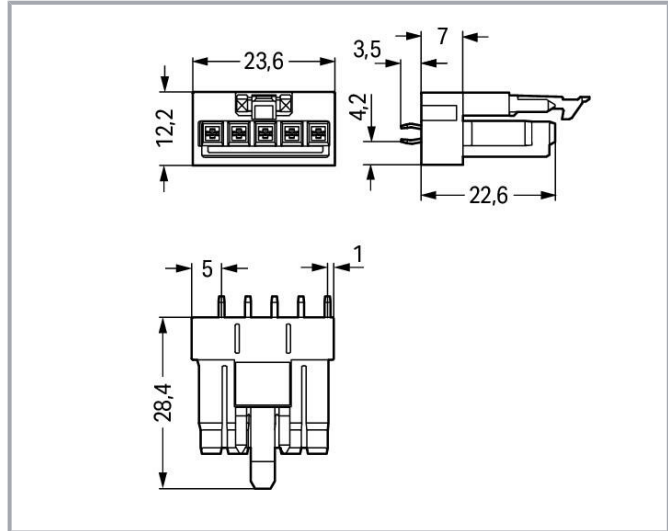

* ± 0.05 mm
Drilled hole diameter: 1.3^{+0.1} mm

Subject to changes. Please also observe the further product documentation!

WAGO GmbH & Co. KG
Hansastr. 27
32423 Minden
Phone: +49571 887-0 | Fax: +49571 887-169
Email: info.de@wago.com | Web: www.wago.com

Do you have any questions about our products?
We are always happy to take your call at +49 (571) 887-44222.



Item description

Female connector/socket WINSTA® MINI I coding

The WINSTA® MINI female connector/socket I coding are compact but powerful PCB terminal blocks. They offer convenient operation and the greatest possible flexibility for installation. Our pluggable PCB connectors provide a versatile pluggable connection system for your devices that meets all the requirements for a robust device connection. The coding options reduce installation errors, allowing fast, maintenance-free wiring of all components. I coding in blue is used to identify WINSTA® MINI pcb connectors, which are used primarily in building automation for controlling lighting. WINSTA® MINI satisfies the demand for miniaturisation. Our smallest pluggable connection system is very good for lights, for instance, since due to LED technology, these offer much less space for the connection technology.

Lower costs through fast commissioning and elimination of service expenses – solutions from WINSTA® MINI

The WINSTA® Pluggable Connection System allows pluggable electrical installation. This saves time, lowers costs, and reduces the need for servicing. Now you can also cut installation expenses without compromising quality and safety: The WINSTA® MINI pcb connector with locking lever eliminates the need for servicing and prevents unnecessary downtime.

- protection against mismatching eliminates errors
- compact design for conductors with a cross-section up to 1.5 mm²
- with I coding for controlling light (DALI standard)
- convenient installation and commissioning

Data

Electrical data

Ratings per IEC/EN

Ratings per	IEC/EN 60664-1
Nominal voltage (III/3)	250 V
Rated impulse voltage (III/3)	4 kV
Rated current	16 A
Legend (ratings)	(III / 3) ≙ Overvoltage category III / Pollution degree 3

Ratings per UL 1977

Note for the US market

Some versions may also be used for current interruption in accordance with the UL certificate in select applications with

Subject to changes. Please also observe the further product documentation!



currents below 5 A and voltages up to 600 V. For further information, please contact your local sales office.

Rated voltage (UL 1977)	600 V
Rated current UL 1977	12 A

General

Note on contact resistance	approx. 1 mΩ of contact resistance approx. 0.25 mΩ contact transition plug/socket
----------------------------	--

Connection data

Total number of potentials	5
Number of levels	1

Connection 1

Pole number	5
-------------	---

Physical data

Pin spacing	4.4 mm / 0.173 inches
Width	23.6 mm / 0.929 inches
Height	31.9 mm / 1.256 inches
Height from the surface	28.4 mm / 1.118 inches
Depth	12.2 mm / 0.48 inches
Solder pin length	3.5 mm
Solder pin dimensions	1 x 0.8 mm
Drilled hole diameter with tolerance	1.3 ^(+0.1) mm

Mechanical Data

Application	DALI, Lighting Management
Coding	I
Variable coding	No
Marking	N \perp L - +
Potential marking	N \perp L - +
Mating force of a plug-in connection	approx. 20 ... 70 N (depending on pole number)
Retention force of a plug-in connection	Locked: > 80 N
Unmating force of a plug-in connection	Unlocked: approx. 20 ... 70 N (depending on pole number)
Number of mating cycles	200, without resistive load

Subject to changes. Please also observe the further product documentation!



Design	straight
--------	----------

Plug-in connection

Contact type (pluggable connector)	Female connector/socket
Connector (connection type)	for PCB
Mismating protection	Yes
Note on mismating protection	All <i>WINSTA</i> [®] components are 100% protected against mismating when: a.) plugging different numbers of poles b.) plugging while rotated 180 c.) plugging while laterally staggered d.) plugging one pole
Mating direction to the PCB	90 °
Locking lever	yes
Locking of plug-in connection	locking lever
Note on locking system	All connectors for mounted installations (snap-in versions for lighting fixtures or devices, all types of PCB and distribution connectors) are factory-equipped with locking levers to ensure plugs and sockets are securely locked. Additional locking levers are only required for flying leads (plug/socket).

PCB contact

PCB contact	THT
Solder pin arrangement	2 in-line solder pins/pole
Number of solder pins per potential	2

Material Data

Note (material data)	Information on material specifications can be found here
Color	blue
Cover color	gray
Material group	I
Insulation material	Polyamide (PA66)
Flammability class per UL94	V0
Clamping spring material	Chrome-nickel spring steel (CrNi)
Contact material	Copper or copper alloy; surface-treated
Contact plating	Tin
Fire load	0.092 MJ

Subject to changes. Please also observe the further product documentation!

Weight	5.3 g
--------	-------

Environmental requirements

Processing temperature	-5 ... +40 °C
Continuous operating temperature	-35 ... +85 °C
Note on continuous operating temperature	Insulating parts for temperatures ≤ 105 °C

Commercial data



Product Group	20 (Winsta)
eCl@ss 10.0	27-44-06-05
eCl@ss 9.0	27-44-06-05
ETIM 8.0	EC002560
ETIM 7.0	EC002560
PU (SPU)	50 pcs
Packaging type	box
Country of origin	PL
GTIN	4050821695905
Customs tariff number	85366990990

Environmental Product Compliance

RoHS Compliance Status	Compliant, No Exemption
------------------------	-------------------------

Approvals / Certificates

General approvals

Logo	Approval	Additional Approval Text	Certificate name
	CCA DEKRA Certification B.V.	EN 61535	71- 123231
	CCA DEKRA Certification B.V.	IEC 61535	NL-85020
	cURus Underwriters Laboratories Inc.	UL 1977	E45171



Declarations of conformity and manufacturer's declarations

Certificate



Subject to changes. Please also observe the further product documentation!

WAGO GmbH & Co. KG
 Hansastr. 27
 32423 Minden
 Phone: +49571 887-0 | Fax: +49571 887-169
 Email: info.de@wago.com | Web: www.wago.com



Do you have any questions about our products?
 We are always happy to take your call at +49 (571) 887-44222.

Logo	Approval	Additional Approval Text	name
	EU-Declaration of Conformity WAGO GmbH & Co. KG	-	-
	UK-Declaration of Conformity WAGO GmbH & Co. KG	-	-

Approvals for marine applications

Logo	Approval	Additional Approval Text	Certificate name
	ABS American Bureau of Shipping	Steel Vessel Rules	19- HG1869855- PDA
	DNV GL Det Norske Veritas, Germanischer Lloyd	-	TAE00001Z6
	LR Lloyds Register	EN 61535	08/20047 (E2)

Counterpart

	Item no.890-1115 Plug; 5-pole; Cod. I; 1,50 mm ² ; blue	www.wago.com/890-1115
	Item no.891-8985/006-101 pre-assembled interconnecting cable; Eca; Socket/plug; 5-pole; Cod. I; H05VV-F 5G 1.5 mm ² ; 1 m; 1,50 mm ² ; blue	www.wago.com/891-8985/006-101
	Item no.891-8985/206-101 pre-assembled connecting cable; Eca; Plug/open-ended; 5-pole; Cod. I; H05VV-F 5G 1.5 mm ² ; 1 m; 1,50 mm ² ; blue	www.wago.com/891-8985/206-101

Downloads

CAD/CAE-Data

CAD data

2D/3D Models 890-3105

URL

Download

Subject to changes. Please also observe the further product documentation!

WAGO GmbH & Co. KG

Hansastr. 27

32423 Minden

Phone: +49571 887-0 | Fax: +49571 887-169

Email: info.de@wago.com | Web: www.wago.com

Do you have any questions about our products?

We are always happy to take your call at +49 (571) 887-44222.

PCB Design

Symbol and Footprint 890-3105

[URL](#)

[Download](#)

CAX data for your PCB design, consisting of "schematic symbols and PCB footprints", allow easy integration of the WAGO component into your development environment.

Supported formats:

- Accel EDA 14 & 15
- Altium 6 to current version
- Cadence Allegro
- DesignSpark
- Eagle Libraries
- KiCad
- Mentor Graphics BoardStation
- Mentor Graphics Design Architect
- Mentor Graphics Design Expedition 99 and 2000
- OrCAD 9.X PCB and Capture
- PADS PowerPCB 3, 3.5, 4.X, and 5.X
- PADS PowerPCB and PowerLogic 3.0
- PCAD 2000, 2001, 2002, 2004, and 2006
- Pulsonix 8.5 or newer
- STL
- 3D STEP
- TARGET 3001!
- View Logic ViewDraw
- Quadcept
- Zuken CadStar 3 and 4
- Zuken CR-5000 and CR-8000

PCB Component Libraries (EDA), PCB CAD Library Ultra Librarian

CAE data

ZUKEN Portal 890-3105

[URL](#)

[Download](#)

Environmental Product Compliance

Compliance Search

Environmental Product Compliance 890-3105

Subject to changes. Please also observe the further product documentation!

WAGO GmbH & Co. KG

Hansastr. 27

32423 Minden

Phone: +49571 887-0 | Fax: +49571 887-169

Email: info.de@wago.com | Web: www.wago.com

Do you have any questions about our products?

We are always happy to take your call at +49 (571) 887-44222.

Data sheet | Item number: 890-3105

www.wago.com/890-3105



[URL](#)

[Download](#)

Socket for PCBs; straight; 5-pole; Cod. I; blue

Installation Notes

Product family

WINSTA® MINI

[Show all products from the family](#)

Subject to changes. Please also observe the further product documentation!

WAGO GmbH & Co. KG

Hansastr. 27

32423 Minden

Phone: +49571 887-0 | Fax: +49571 887-169

Email: info.de@wago.com | Web: www.wago.com

Do you have any questions about our products?

We are always happy to take your call at +49 (571) 887-44222.