

Item description

Male connector/plug *WINSTA*® MINI B coding

The *WINSTA*® MINI male connector/plug B coding is the pluggable solution for your application in control cabinets, for lighting connections or on PCBs. The pluggable installation connectors with spring pressure connection technology function entirely without screw connections. They allow resource-efficient, error-free installation in a large number of applications. For greater security in electrical installations, the pluggable installation connector is provided with mechanical protection against mismatching. Pluggable installation connectors with B coding from the *WINSTA*® MINI line are available in gray, light green, or pink, allowing you to distinguish different circuits, for example for pumps, lighting, or sun blinds. Your own pole marking is possible as well. Due to its particularly small dimensions, our *WINSTA*® MINI Pluggable Connection System with Push-in CAGE CLAMP® spring pressure connection technology is especially suitable in very tight spaces, i.e., for connections when very little room is available.

Lower costs through fast commissioning and elimination of service expenses – solutions from *WINSTA*® MINI

Subject to changes. Please also observe the further product documentation!



The WINSTA® Pluggable Connection System is perfectly tailored to the very strict requirements of building installation. It makes electrical installation pluggable, and consequently faster, more reliable, and error-free. Using this pre-assembled system reduces time spent on assembly and errors during installation at the construction site. Choose durability and quality – the WINSTA® MINI pluggable installation connector with protection against mismatching from WAGO makes the electrical installation of electrical components substantially easier.

- protection against mismatching eliminates errors
- compact design for conductors with a cross-section up to 1.5 mm²
- with B coding for controllers such as sun blinds and lighting fixtures
- custom-engineered solutions
- convenient installation and commissioning

Data

Notes

Variants:

Other pole markings

Other versions (or variants) can be requested from WAGO Sales or configured at <https://configurator.wago.com/>.

Electrical data

Ratings per IEC/EN

Ratings per	IEC/EN 60664-1
Nominal voltage (III/3)	400 V
Rated impulse voltage (III/3)	6 kV
Rated current	16 A
Note (rated current)	13 A for 3-pole load 10 A for 4-pole load
Legend (ratings)	(III / 3) ≙ Overvoltage category III / Pollution degree 3

Ratings per UL 1977

Note for the US market	Some versions may also be used for current interruption in accordance with the UL certificate in select applications with currents below 5 A and voltages up to 600 V. For further information, please contact your local sales office.
Rated voltage (UL 1977)	600 V
Rated current UL 1977	12 A

Subject to changes. Please also observe the further product documentation!

WAGO GmbH & Co. KG
 Hansastr. 27
 32423 Minden
 Phone: +49571 887-0 | Fax: +49571 887-169
 Email: info.de@wago.com | Web: www.wago.com

Do you have any questions about our products?
 We are always happy to take your call at +49 (571) 887-44222.



General

Note on contact resistance	approx. 1 mΩ of contact resistance approx. 0.25 mΩ contact transition plug/socket
----------------------------	--

Connection data

Connection points	4
Total number of potentials	4

Connection 1

Connection technology	Push-in CAGE CLAMP®
Actuation type	Operating tool Push-in
Nominal cross-section	1.5 mm ² / 16 AWG
Solid conductor	0.25 ... 1.5 mm ² / 22 ... 16 AWG
Solid conductor; push-in termination	0.75 ... 1.5 mm ² / 20 ... 16 AWG
Stranded conductor	0.25 ... 1 mm ² / 22 ... 18 AWG
Fine-stranded conductor	0.25 ... 1.5 mm ² / 22 ... 16 AWG
Fine-stranded conductor; with insulated ferrule	0.25 ... 0.75 mm ² / 22 ... 20 AWG
Fine-stranded conductor; with uninsulated ferrule	0.25 ... 0.75 mm ² / 22 ... 20 AWG
Fine-stranded conductor; with ferrule; push-in termination	0.75 mm ² / 20 AWG
Strip length	9 mm / 0.35 inches
Pole number	4
Conductor entry direction to mating direction	0°

Physical data

Pin spacing	4.4 mm / 0.173 inches
Width	19.2 mm / 0.756 inches
Height	11.7 mm / 0.461 inches
Depth	34.1 mm / 1.343 inches

Mechanical Data

Application	Control technology
Coding	B
Variable coding	No
Marking	AI DI U+ U-
Potential marking	AI DI U+ U-

Subject to changes. Please also observe the further product documentation!



Mating force of a plug-in connection	approx. 20 ... 70 N (depending on pole number)
Retention force of a plug-in connection	Locked: > 80 N
Unmating force of a plug-in connection	Unlocked: approx. 20 ... 70 N (depending on pole number)
Number of mating cycles	200, without resistive load
Protection type	IP20; IP40 when mated with strain relief housing

Plug-in connection

Contact type (pluggable connector)	Male connector/plug
Connector (connection type)	for conductor
Mismating protection	Yes
Note on mismating protection	All <i>WINSTA</i> [®] components are 100% protected against mismating when: a.) plugging different numbers of poles b.) plugging while rotated 180 c.) plugging while laterally staggered d.) plugging one pole
Locking lever	Can be retrofitted
Locking of plug-in connection	locking lever
Note on locking system	All connectors for mounted installations (snap-in versions for lighting fixtures or devices, all types of PCB and distribution connectors) are factory-equipped with locking levers to ensure plugs and sockets are securely locked. Additional locking levers are only required for flying leads (plug/socket).

Material Data

Note (material data)	Information on material specifications can be found here
Color	light green
Cover color	gray
Material group	I
Insulation material	Polyamide (PA66)
Flammability class per UL94	V0
Clamping spring material	Chrome-nickel spring steel (CrNi)
Contact material	Copper or copper alloy; surface-treated
Contact plating	Tin
Fire load	0.113 MJ
Weight	4.6 g

Subject to changes. Please also observe the further product documentation!

Environmental requirements

Processing temperature	-5 ... +40 °C
Continuous operating temperature	-35 ... +85 °C
Note on continuous operating temperature	Insulating parts for temperatures ≤ 105 °C

Commercial data

eCl@ss 10.0	27-44-06-05
eCl@ss 9.0	27-44-06-05
ETIM 8.0	EC002560
ETIM 7.0	EC002560
PU (SPU)	50 pcs
Packaging type	box
Country of origin	PL
GTIN	4055143523653
Customs tariff number	85366990990

Environmental Product Compliance

RoHS Compliance Status	Compliant, No Exemption
------------------------	-------------------------

Approvals / Certificates

General approvals

Logo	Approval	Additional Approval Text	Certificate name
	CB DEKRA Certification B.V.	IEC 61984	NL-64351
	CB DEKRA Certification B.V.	EN 61984	71- 112993

Declarations of conformity and manufacturer's declarations

Logo	Approval	Additional Approval Text	Certificate name
	EU-Declaration of Conformity WAGO GmbH & Co. KG	-	-
	UK-Declaration of Conformity WAGO GmbH & Co. KG	-	-



Subject to changes. Please also observe the further product documentation!



Approvals for marine applications





Logo	Approval	Additional Approval Text	Certificate name
	LR Lloyds Register	EN 61535	08/20047 (E2)

Counterpart

	Item no.890-264/072-000 Socket; 4-pole; Cod. B; 1,50 mm ² ; light green	www.wago.com/890-264/072-000
	Item no.890-764/072-000 Snap-in socket; 4-pole; Cod. B; 1,50 mm ² ; light green	www.wago.com/890-764/072-000

Required accessories

Locking levers

Locking system		
	Item no.: 890-111 Locking lever; for flying leads; for tool operation; black	www.wago.com/890-111
	Item no.: 890-101 Locking lever; for manual operation; black	www.wago.com/890-101
	Item no.: 890-121 Locking lever; for manual operation; white	www.wago.com/890-121
	Item no.: 890-131 Locking lever; for flying leads; for tool operation; white	www.wago.com/890-131

Strain relief

Strain relief housing

Subject to changes. Please also observe the further product documentation!



Item no.: 890-504

Strain relief housing; 4-pole; with locking clip; for 1 cable; 6.5 ... 10.5 mm; 45 mm; black

www.wago.com/890-504



Item no.: 890-514

Strain relief housing; 4-pole; with locking clip; for 1 cable; 6.5 ... 10.5 mm; 45 mm; white

www.wago.com/890-514

Optional accessories

Cover

Cover



Item no.: 897-2003

Protective cap; Type2; for sockets and plugs; PVC; red

www.wago.com/897-2003

Tool

Operating tool



Item no.: 210-719

Operating tool; Blade: 2.5 x 0.4 mm; with a partially insulated shaft

www.wago.com/210-719



Item no.: 890-384

Operating tool; 4-way; green

www.wago.com/890-384

Mounting

Mounting accessories



Item no.: 890-310

Mounting carrier; 2- to 5-pole; for flying leads; black

www.wago.com/890-310



Item no.: 890-311

Mounting carrier; 2- to 5-pole; for flying leads; white

www.wago.com/890-311

Downloads

Documentation

Bid Text

890-274/072-000	2019 Feb 19	xml	Download
X81 - Datei		3.0 kB	
890-274/072-000	2015 Jun 8	doc	Download

Subject to changes. Please also observe the further product documentation!

WAGO GmbH & Co. KG

Hansastr. 27

32423 Minden

Phone: +49571 887-0 | Fax: +49571 887-169

Email: info.de@wago.com | Web: www.wago.com

Do you have any questions about our products?

We are always happy to take your call at +49 (571) 887-44222.

CAD/CAE-Data

CAD data

2D/3D Models 890-274/072-000

[URL](#)

[Download](#)

CAE data

ZUKEN Portal 890-274/072-000

[URL](#)

[Download](#)

Environmental Product Compliance

Compliance Search

Environmental Product Compliance 890-274/072-000

[URL](#)

[Download](#)

Plug; 4-pole; 1,50 mm²; light green

Installation Notes

Conductor termination

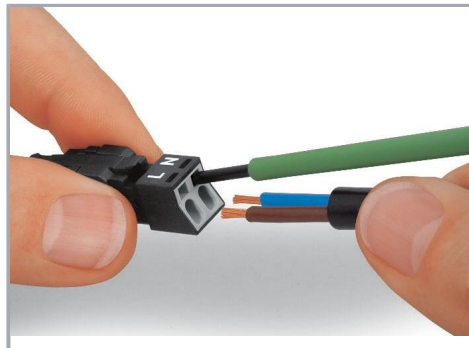
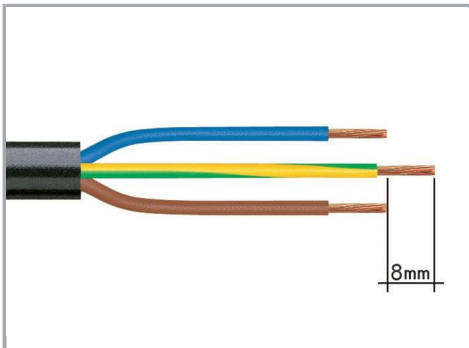

1. Strip length, outer insulation = 30 mm (2-pole), 37 mm (3-pole), 45 mm (4- and 5-pole)

2. Strip length = 9 mm

3. Extended ground conductor = 8 mm

To terminate fine-stranded conductors, open the clamping unit via screwdriver – 2.5 mm blade width – and insert a stripped conductor until it hits the backstop.

Terminate solid conductors by simply pushing them in.

Subject to changes. Please also observe the further product documentation!

WAGO GmbH & Co. KG

Hansastr. 27

32423 Minden

Phone: +49571 887-0 | Fax: +49571 887-169

Email: info.de@wago.com | Web: www.wago.com

Do you have any questions about our products?

We are always happy to take your call at +49 (571) 887-44222.

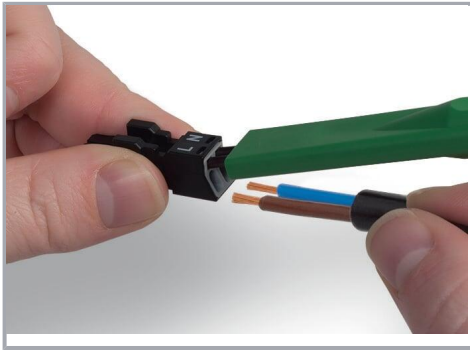

To terminate fine-stranded conductors, open clamping units via operating tool (890-382) and insert stripped conductors until they hit backstop.

Terminate solid conductors by simply pushing them in.

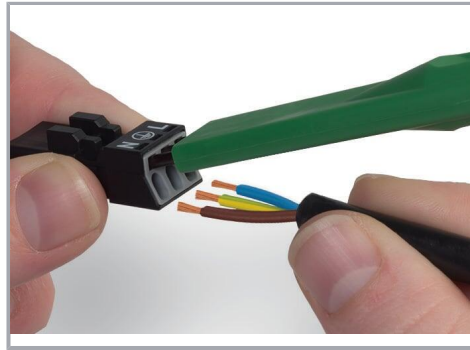

To terminate fine-stranded conductors, open clamping units via operating tool (890-383) and insert stripped conductors until they hit backstop.

Terminate solid conductors by simply pushing them in.

Installation

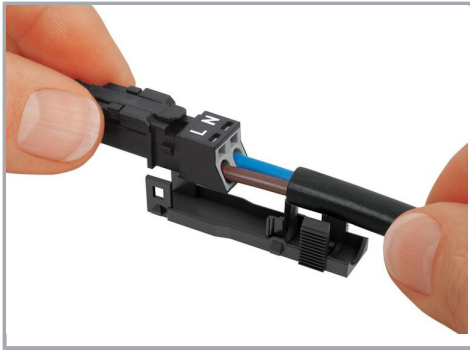

Latch the wired connector into the base of the strain relief housing.

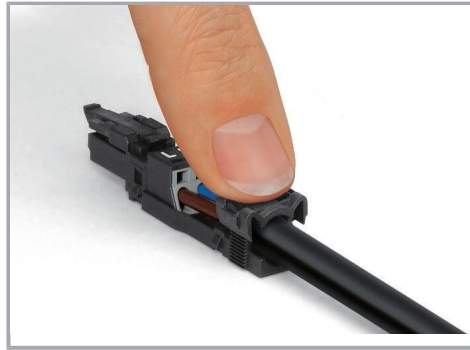

Push down strain relief clamp by hand.

Subject to changes. Please also observe the further product documentation!



Push down strain relief clamp with 2.5 mm screwdriver alternately on both sides.

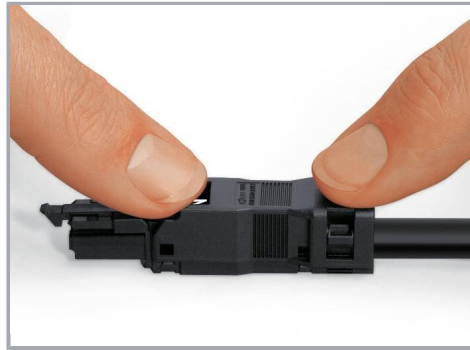

Latch the top of the strain relief housing.



The printed marking of the connector is clearly visible in the openings of the strain relief housing.

Mismatching protection

Subject to changes. Please also observe the further product documentation!

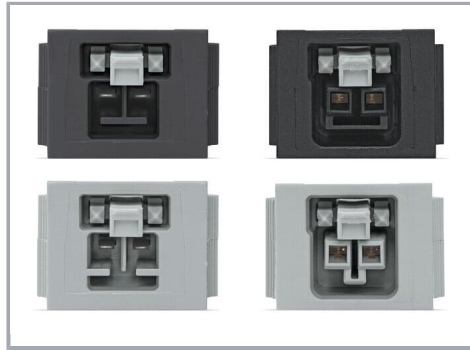
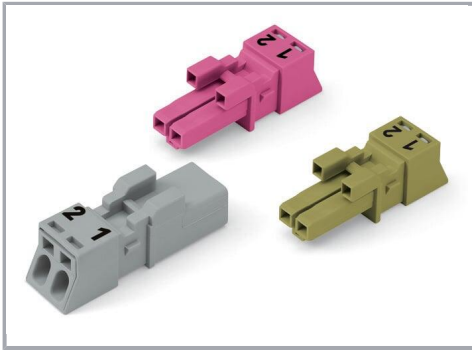

B-coded connectors with different colors can be plugged together.

Important note:

Different colors and/or pole markings are used for circuit identification.

Only connectors of the same color and same pole marking must be plugged together.

B-coded connectors (shown in gray) not only differ in color, but also in their design, making them incompatible with other coded connectors.



Product family

WINSTA® MINI

[Show all products from the family](#)

Subject to changes. Please also observe the further product documentation!