

4

3

2

1

THIS DRAWING IS UNPUBLISHED. RELEASED FOR PUBLICATION. ALL RIGHTS RESERVED.

LOC	DIST	REVISIONS					
GP	00	P	LTR	DESCRIPTION	DATE	DWN	APVD
		A1		NOT LOW HALOGEN	15MAR2018	KY	DZ

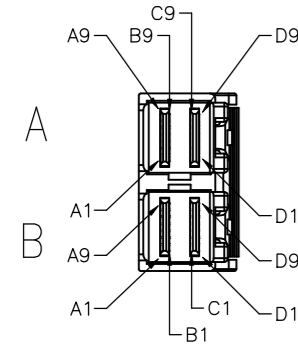
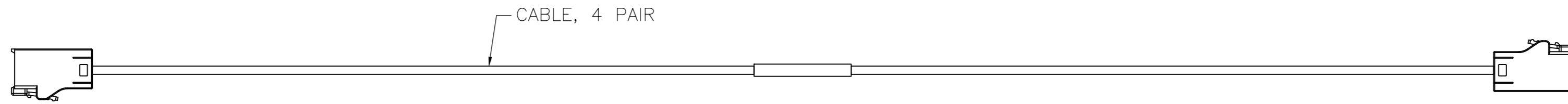

P1

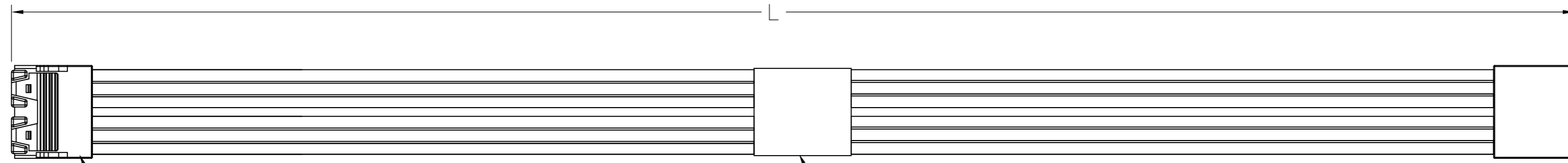

PLUG, MINI-SAS HD

LABEL

3

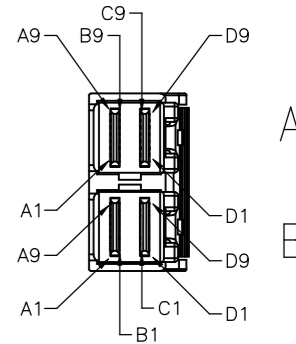

P2

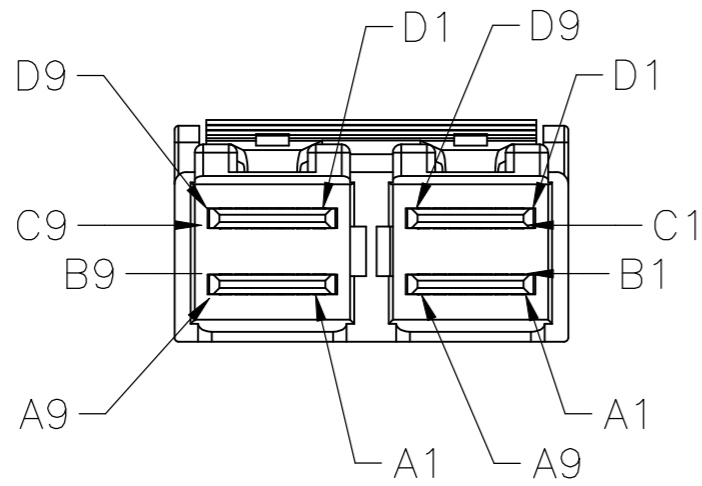

CONNECTOR FACE - LATCH UP

1. ASSEMBLY TO BE 100% TESTED FOR CONTINUITY, SHORTS, AND OPENS, CABLES ASSEMBLYS ARE ALSO TO BE 100% TESTED FOR SIGNAL INTEGRITY, TO SAS 3.0 REQUIREMENTS.

2. ROHS AND REACH COMPLIANCE: PRODUCT AND PROCESSING MEETS REQUIREMENTS OF TE SPECIFICATION TEC-138-702.

3. LABEL CENTERED AND LABEL INFORMATION AS BELOW:

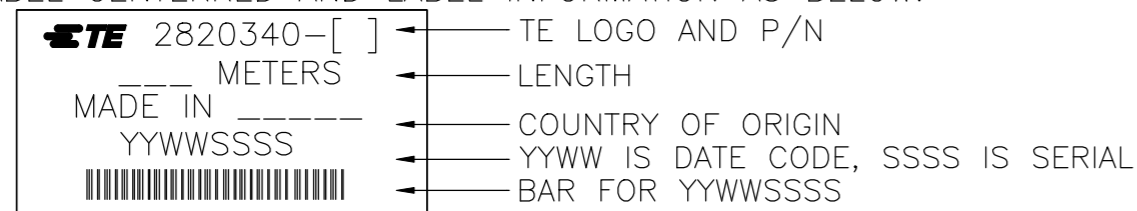

4. SEE SHEET #2 FOR WIRING SCHEMATIC.

500	+25 -0	2820340-2
300	+25 -0	2820340-1
"L"	[MM]	TE P/N

THIS DRAWING IS A CONTROLLED DOCUMENT.		DWN	M.YI	16/JUN/2014	TE TE Connectivity
DIMENSIONS: mm		CHK	G.GUTGOLD	16/JUN/2014	
TOLERANCES UNLESS OTHERWISE SPECIFIED:		APVD	G.GUTGOLD	16/JUN/2014	NAME
0 PLC ± -		PRODUCT SPEC			C/A, INTERNAL HD MINI SAS, STR TO STR
1 PLC ± -		APPLICATION SPEC			85 OHMS, 8X
2 PLC ± -					
3 PLC ± -					
4 PLC ± -					
ANGLES ± -					
MATERIAL		WEIGHT			SIZE
					A2
					CAGE CODE
					00779
					DRAWING NO
					C=2820340
					RESTRICTED TO
					-
					SCALE
					N.T.S.
					SHEET
					1 of 2
					REV
					A1

THIS DRAWING IS UNPUBLISHED. RELEASED FOR PUBLICATION
 © COPYRIGHT - By - ALL RIGHTS RESERVED.

LOC	DIST	REVISIONS					
GP	00	P	LTR	DESCRIPTION	DATE	DWN	APVD
		-		SEE SHEET 1	-	-	-

P1-A P2-A

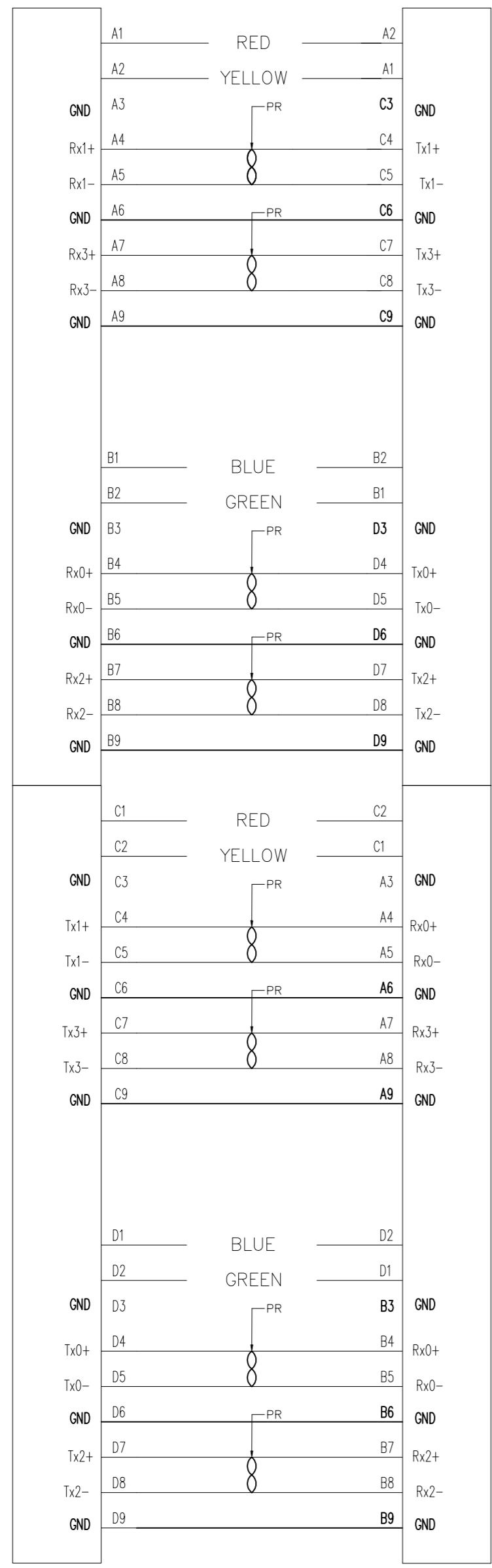

P1-B P2-B

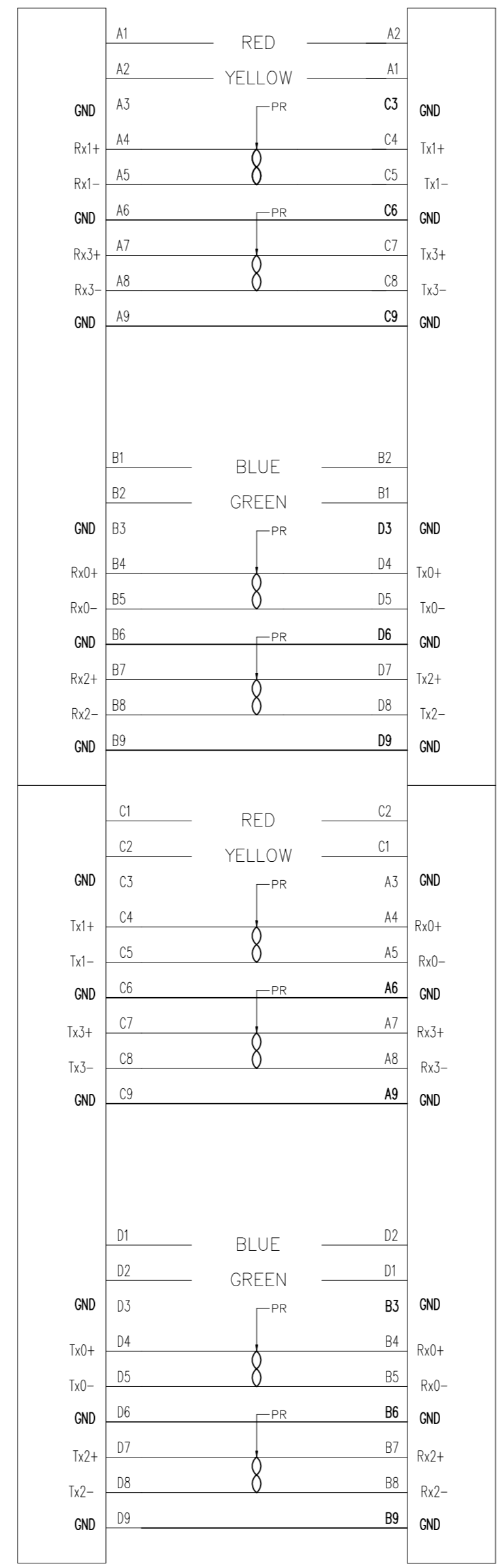

WIRING PATTERN

THIS DRAWING IS A CONTROLLED DOCUMENT.		DWN M.YI 16/JUN/2014		TE Connectivity	
DIMENSIONS: mm		CHK G.GUTGOLD 16/JUN/2014		NAME C/A, INTERNAL HD MINI SAS, STR TO STR 85 OHMS, 8X	
TOLERANCES UNLESS OTHERWISE SPECIFIED: 0 PLC ± - 1 PLC ± - 2 PLC ± - 3 PLC ± - 4 PLC ± - ANGLES ± -		APVD G.GUTGOLD 16/JUN/2014	PRODUCT SPEC		
MATERIAL		APPLICATION SPEC	SIZE A2	CAGE CODE 00779	DRAWING NO C=2820340
		RESTRICTED CUSTOMER	SCALE N.T.S.	SHEET 2 of 2	REV A1

D

C

B

A

D

C

B

A

2820340