

## Specifications

Electrical Ratings	3A @ 120VAC, 28VDC 1A @ 250VAC See Contact Options	Dielectric Strength	1500Vrms min
Electrical Life	50,000 cycles typical	Insulation Resistance	>100MΩ min
Contact Resistance	<20mΩ initial @ 2-4VDC, 100mA	Operating Temperature	-40°C to 85°C
		Storage Temperature	-40°C to 85°C
		Sealing Degree	IP67

## Materials

Actuator	4/6 Nylon, Glass Filled, Flame Retardant Heat Stabilized, UL94V-0
Housing	4/6 Nylon, Glass Filled, Flame Retardant Heat Stabilized, UL94V-0
Support Bracket	Steel, Tin Plated
Contacts	Copper Alloy, Silver or Gold Plated
Terminals	Copper Alloy, Silver or Gold Plated

## Ordering Information

1. Series	ASP	1	1	T	N	H	Q
ASP							
2. Number of Poles							
1 = SPDT							
2 = DPDT							
3. Switch Function							
1 = ON - (ON)							
4. Actuator							
T = 7.11mm, standard							
5. Bushing							
E = 8.80mm, 1/4-40 UNS-2A Threaded							
N = 6.35mm, Non-threaded							
6. Terminals							
B = Solder Lug							
C = PC Pin							
D = Quick Connect							
H = Horizontal mount, right angle PC pin; HS = Snap-In							
V = Vertical mount, right angle PC pin							
S20 = PC pin with support bracket; V20 = Snap-In support bracket							
S25 = PC pin with support bracket; V25 = Snap-In support bracket							
7. Contacts							
Q = Silver plated							
R = Gold plated							
G = Gold over Silver plated							
8. Actuator Cap							
Blank = None							
C73	Actuator Cap Colors						
C74	See Cap Options for color availability						
C75							
C76							
C77							

### Switch Function



**SPDT**



Function	Pushbutton Position	
1	ON	(ON)
Terminals	1-3	1-2

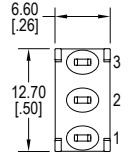
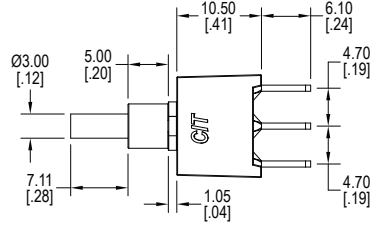
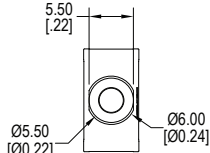

**DPDT**

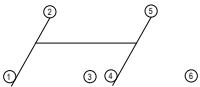

Function	Pushbutton Position	
1	ON	(ON)
Terminals	1-3 4-6	1-2 4-5

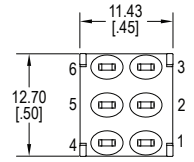
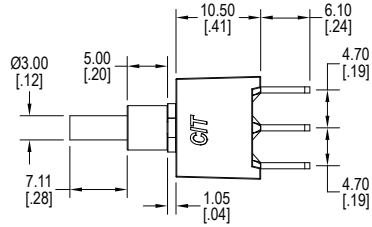
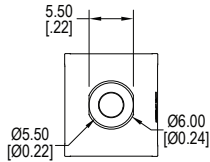

### Actuator Options

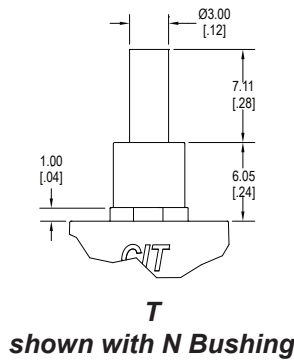
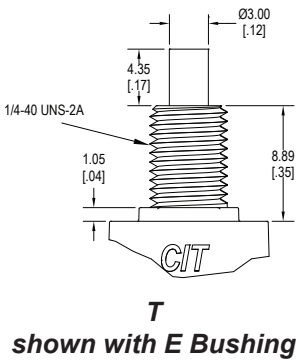

### Bushing Options

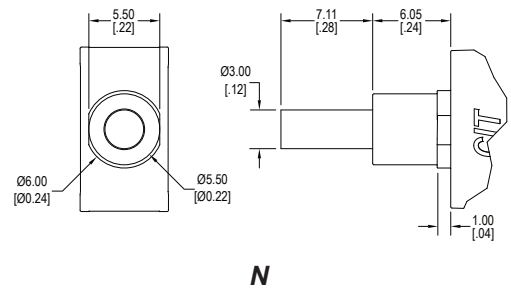
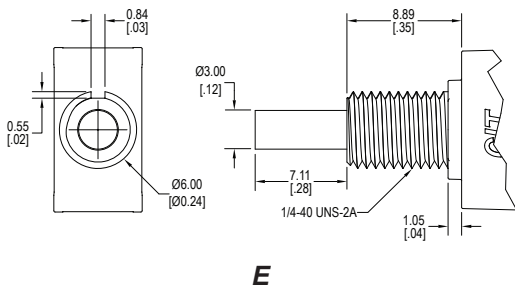

## Panel Mounting

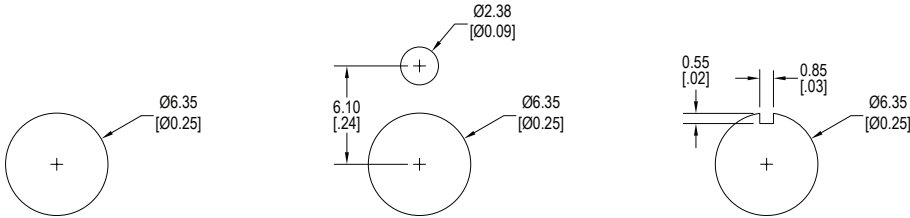

## Terminal Options

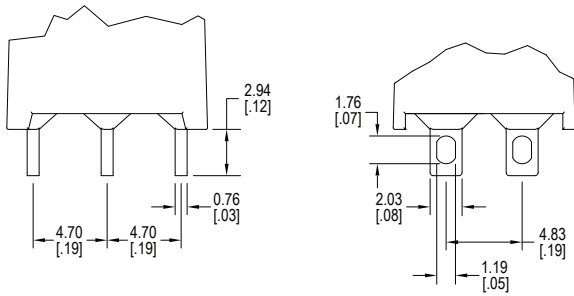

**B**

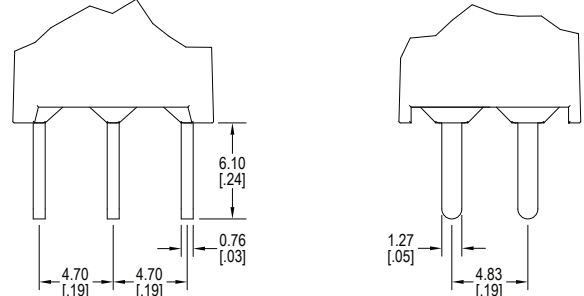

**C**

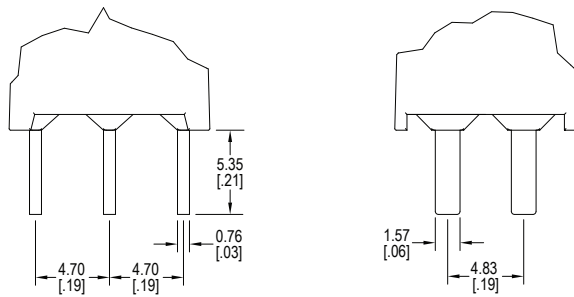

**D**

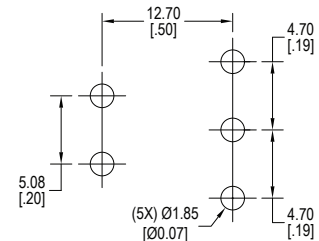
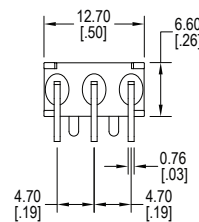
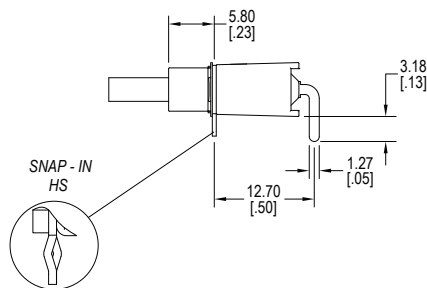
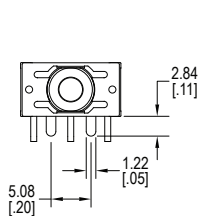
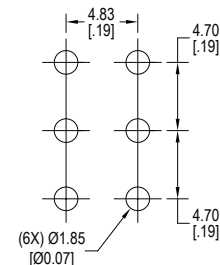

**H (HS - Snap In) = Horizontal mount, right angle PC pins, single pole**

**Terminal Options**

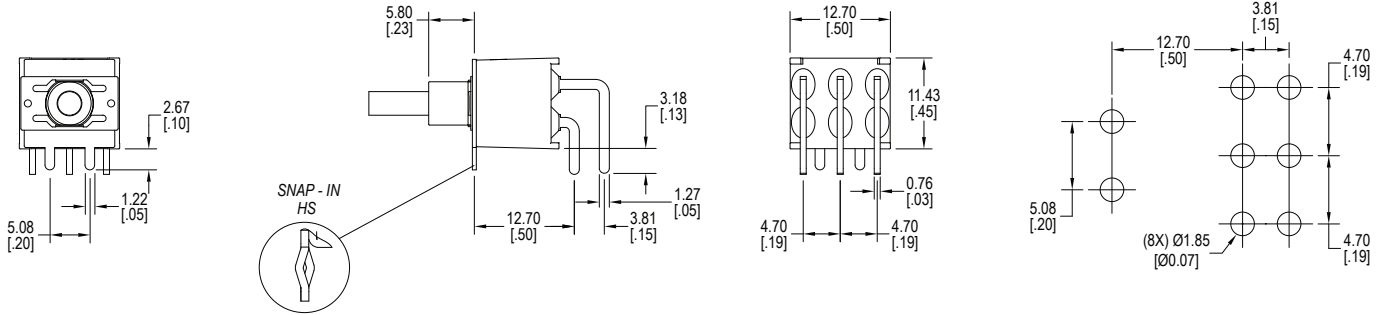

**H (HS - Snap In) = Horizontal mount, right angle PC pins, double pole**

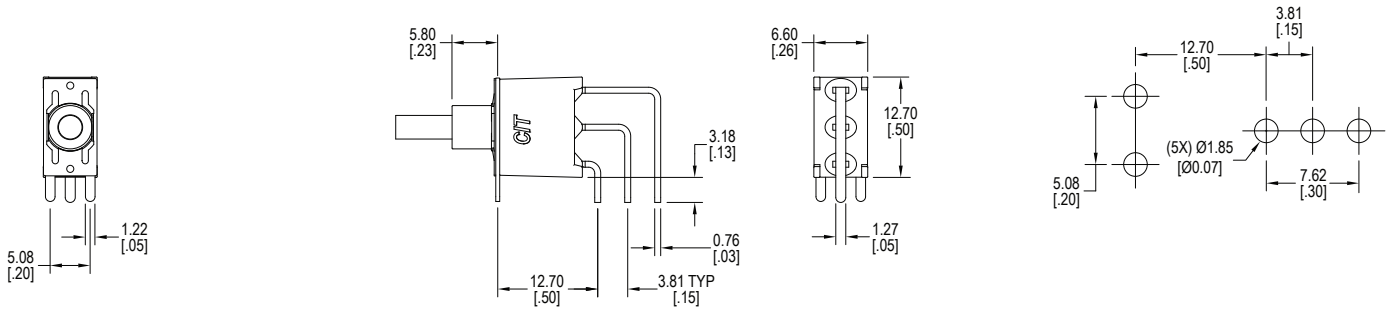

**V = Vertical mount, right angle PC pins, single pole**

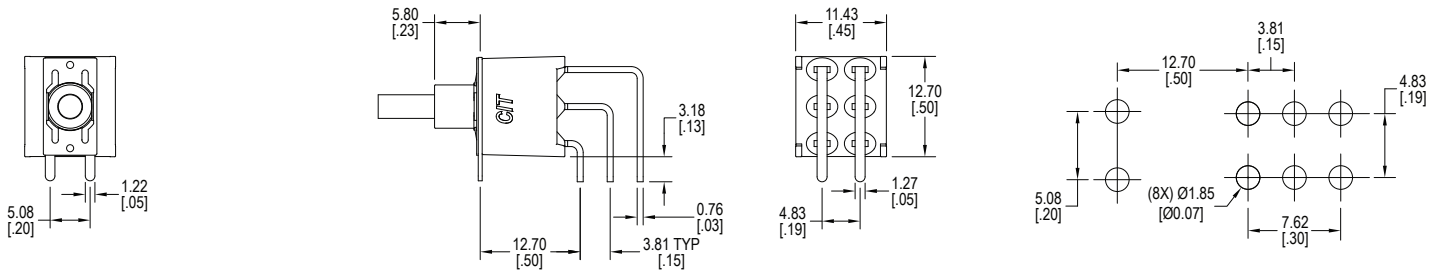

**V = Vertical mount, right angle PC pins, double pole**

## Terminal Options

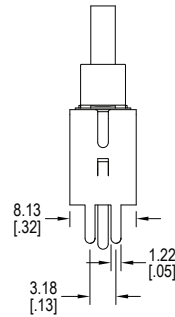
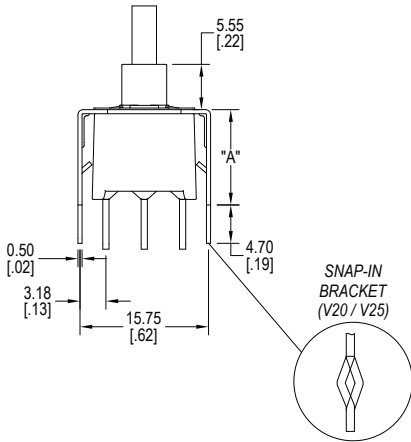

Terminal Option	"A" Dimension
S20 / V20	11.68
S25 / V25	16.00

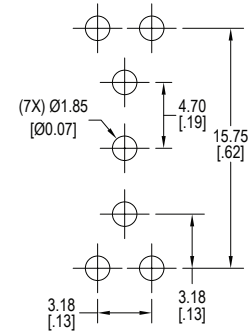

**S20 / S25 (V20/V25 - Snap in bracket) = PC pins with support bracket, single pole**

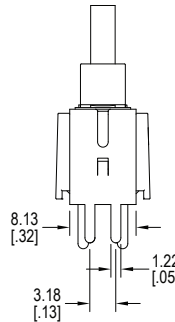
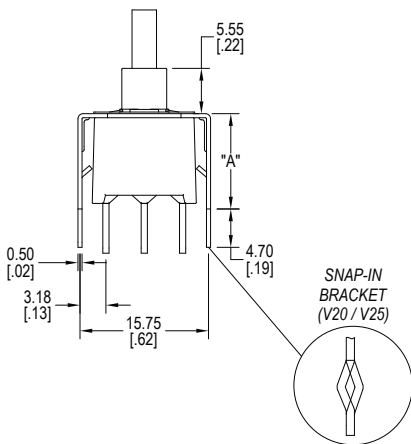

Terminal Option	"A" Dimension
S20 / V20	11.68
S25 / V25	16.00

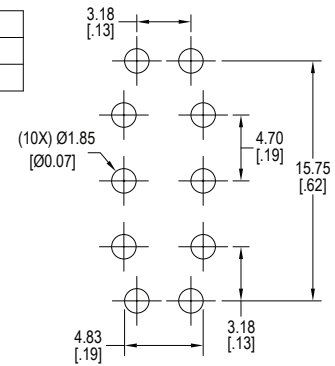

**S20 / S25 (V20/V25 - Snap in bracket) = PC pins with support bracket, double pole**

## Contact Options

Designator	Contact Material	Terminal Material	Electrical Ratings
Q	Silver Plating	Gold over Silver Plating	3A @ 120VAC, 28VDC; 1A @ 250VAC
R	Gold over Nickel Plating	Gold over Nickel Plating	0.4VA max @ 20VAC or VDC max
G	Gold over Silver Plating	Gold over Silver Plating	0.4VA max @ 20VAC or VDC max or 3A @ 120VAC, 28VDC; 1A @ 250VAC

**Cap Options**

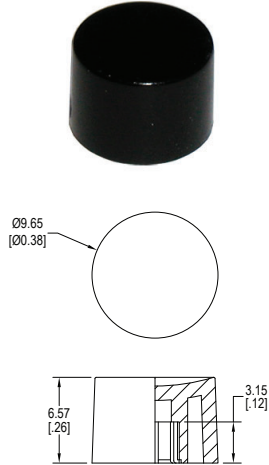

**C73\_**

1 = White, 2 = Black, 3 = Red  
Contact Factory for other available colors

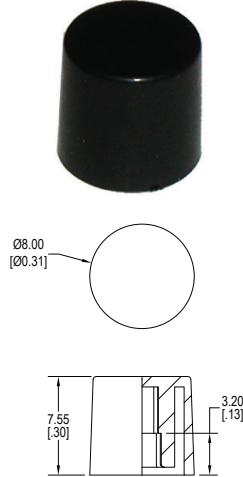

**C74\_**

1 = White, 2 = Black, 3 = Red  
Contact Factory for other available colors

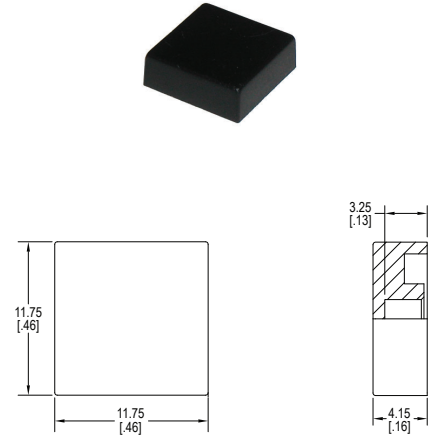

**C75\_**

1 = White, 2 = Black, 3 = Red  
Contact Factory for other available colors

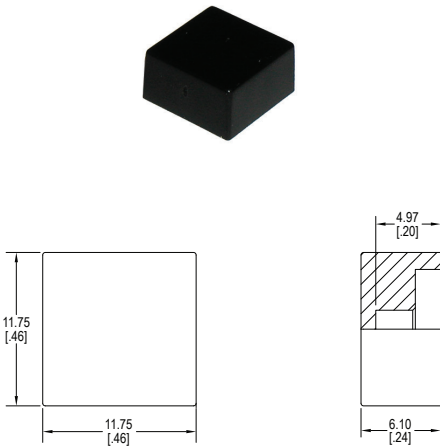

**C76\_**

1 = White, 2 = Black, 3 = Red  
Contact Factory for other available colors

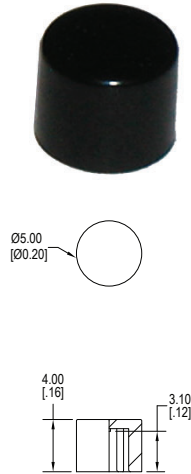

**C77\_**

1 = White, 2 = Black, 3 = Red  
Contact Factory for other available colors

**Hardware** For use with E Bushing

Two hex nuts, one lock washer & one locking ring supplied standard with threaded bushings

