

Inductive sensor

NEB22-30GM60-E2-V1



- 22 mm quasi flush
- Increased operating distance



Dimensions

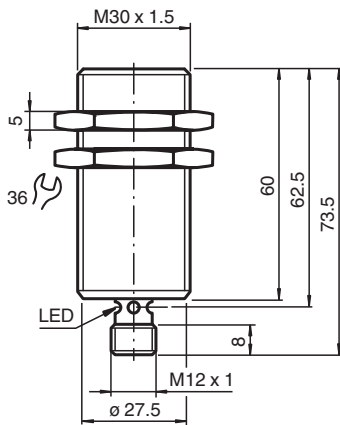

Technical Data

General specifications		
Switching function		Normally open (NO)
Output type		PNP
Rated operating distance	s_n	22 mm
Installation		quasi flush
Output polarity		DC
Assured operating distance	s_a	0 ... 17.8 mm
Reduction factor r_{Al}		0.25
Reduction factor r_{Cu}		0.22
Reduction factor r_{304}		0.65
Output type		3-wire
Nominal ratings		
Installation conditions		
A		6 mm
B		37 mm
C		66 mm

Release date: 2020-03-20 Date of issue: 2020-03-30 Filename: 023490_eng.pdf

Refer to "General Notes Relating to Pepperl+Fuchs Product Information".

Pepperl+Fuchs Group
www.pepperl-fuchs.com

USA: +1 330 486 0001
fa-info@us.pepperl-fuchs.com

Germany: +49 621 776 1111
fa-info@de.pepperl-fuchs.com

Singapore: +65 6779 9091
fa-info@sg.pepperl-fuchs.com

PF PEPPERL+FUCHS

Technical Data

F		80 mm
Operating voltage	U_B	10 ... 30 V
Switching frequency	f	0 ... 150 Hz
Hysteresis	H	≤ 10 %
Reverse polarity protection		reverse polarity protected
Short-circuit protection		pulsing
Voltage drop	U_d	≤ 5 V
Operating current	I_L	0 ... 200 mA
Off-state current	I_r	≤ 0.1 mA
No-load supply current	I_0	≤ 10 mA
Switching state indicator		LED, yellow
Functional safety related parameters		
MTTF _d		213 a
Mission Time (T _M)		20 a
Diagnostic Coverage (DC)		0 %
Compliance with standards and directives		
Standard conformity		
Standards		EN 60947-5-2:2007 IEC 60947-5-2:2007 Non-standard connector assignment
Approvals and certificates		
UL approval		cULus Listed, General Purpose
CSA approval		cCSAus Listed, General Purpose
CCC approval		CCC approval / marking not required for products rated ≤36 V
Ambient conditions		
Ambient temperature		-25 ... 70 °C (-13 ... 158 °F)
Mechanical specifications		
Connection type		Connector plug M12 x 1 , 4-pin
Housing material		chromium plated brass
Sensing face		PBT
Degree of protection		IP67

Connection

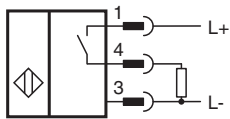

Connection Assignment

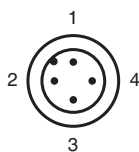



Wire colors in accordance with EN 60947-5-2

1	BN	(brown)
2	WH	(white)
3	BU	(blue)
4	BK	(black)

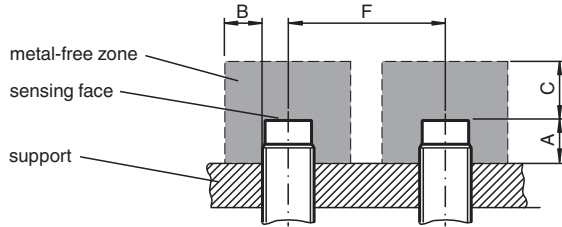
Installation



Accessories

	BF 30	Mounting flange, 30 mm
	V1-G-2M-PUR	Female cordset, M12, 4-pin, PUR cable
	V1-W-2M-PUR	Female cordset, M12, 4-pin, PUR cable

Release date: 2020-03-20 Date of issue: 2020-03-30 Filename: 023490_eng.pdf

Refer to "General Notes Relating to Pepperl+Fuchs Product Information".

Pepperl+Fuchs Group
www.pepperl-fuchs.com

USA: +1 330 486 0001
fa-info@us.pepperl-fuchs.com

Germany: +49 621 776 1111
fa-info@de.pepperl-fuchs.com

Singapore: +65 6779 9091
fa-info@sg.pepperl-fuchs.com