

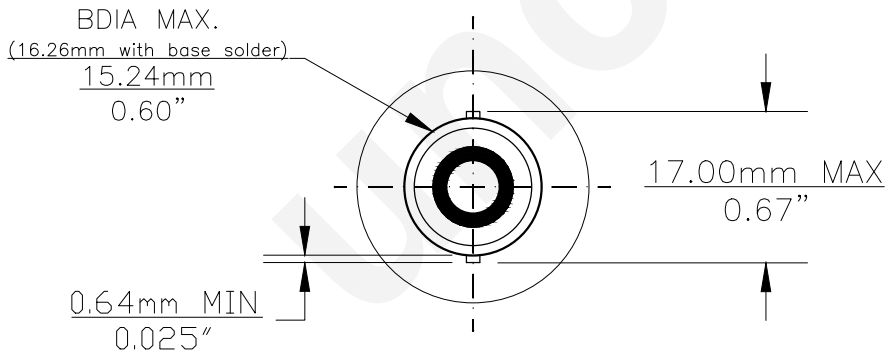

PART NO.	BASE TYPE	DESIGN VOLTS	DESIGN AMPS	MSCD	FILAMENT TYPE	AVERAGE LIFE HOURS	REVISIONS			
							REV #	DESCRIPTION	DATE	APPROVED
1093	S.C. Bayonet (BA15s)	12.8V	1.19±5%	15±15%	C-6	1000	1	ISSUED	07/01/2014	R.M.

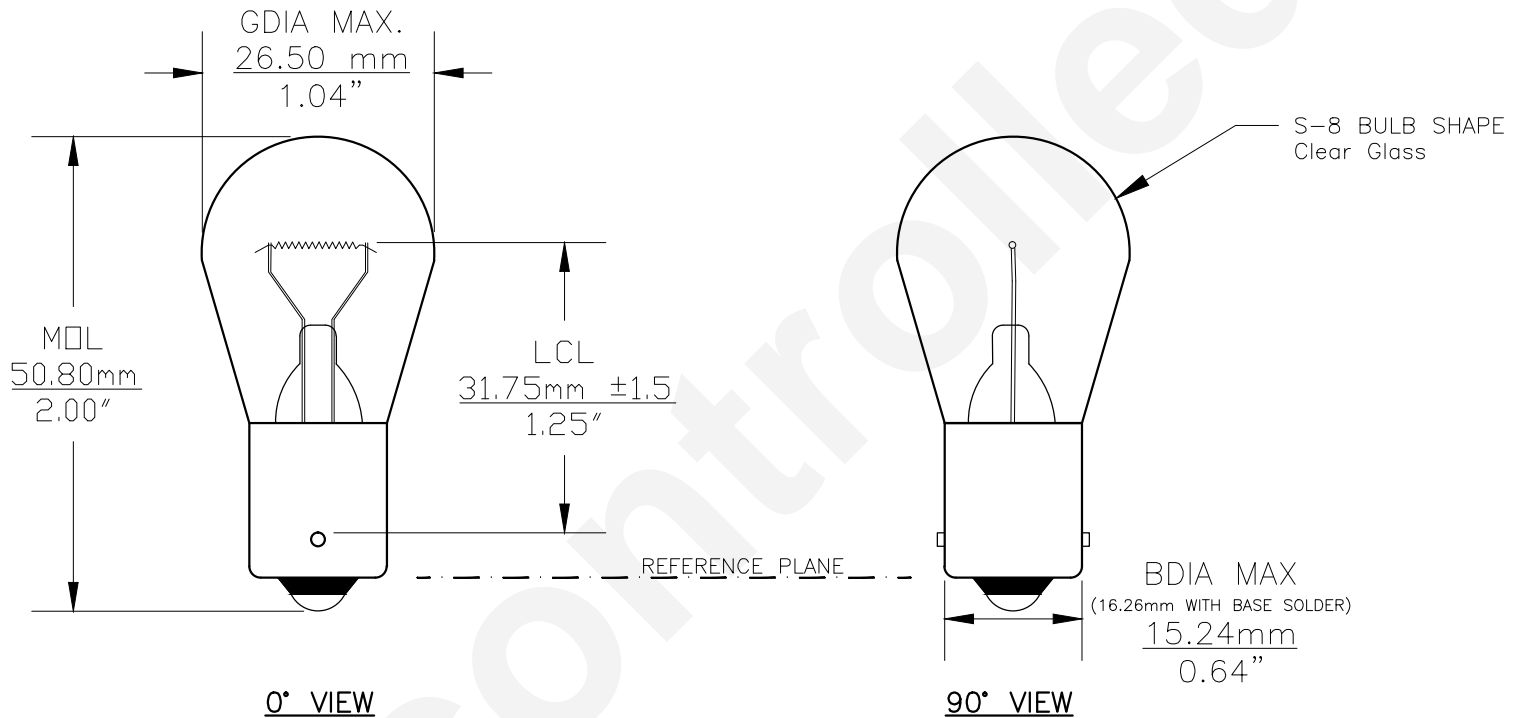

Note: Made according to SAE specifications



UNLESS OTHERWISE SPECIFIED: DIMENSIONS ARE IN INCHES TOLERANCES		CEC INDUSTRIES LTD			
DECIMALS	ANGULAR	599 BOND STREET		LINCOLNSHIRE, IL 60069	
.XX ± .05	± 0.5°	TITLE LIGHT BULB NO. 1093			
.XXX ± .010		SIZE A	FSCM NO.	DWG NO. 1093	REV 1
FRACTIONAL	±1/64	SCALE		PLOT SCALE	SHEET 1 OF 1
DRAWN ROSE MEDINA		DATE 07/01/2014		MATERIAL	
CHECKED		FILE 1093.pdf		DRAWING NOT TO SCALE	