

MIRELLA-50-M-PIN

~30° medium beam

TECHNICAL SPECIFICATIONS:

Dimensions	Ø 49.9 mm
Height	23.9 mm
Fastening	pin
ROHS compliant	yes ⓘ

MATERIAL SPECIFICATIONS:

Component	Type	Material	Colour	Finish	Coating
MIRELLA-50-M-PIN	Reflector	PC	metal		lacquer

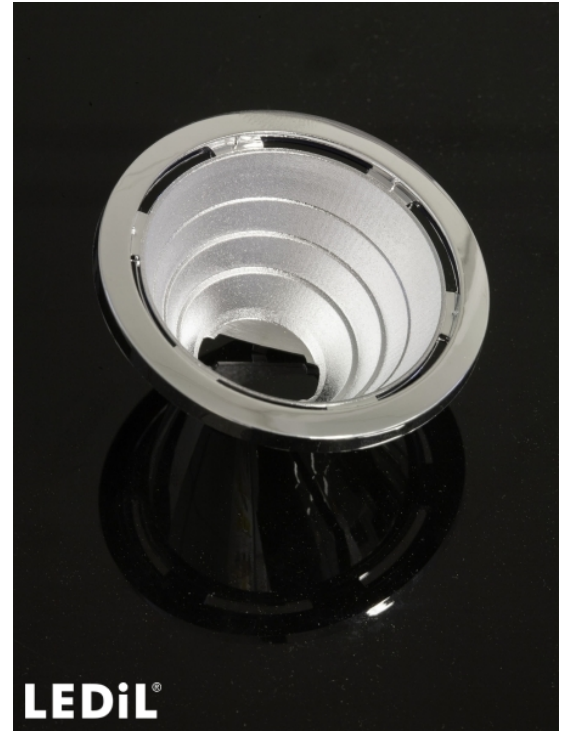





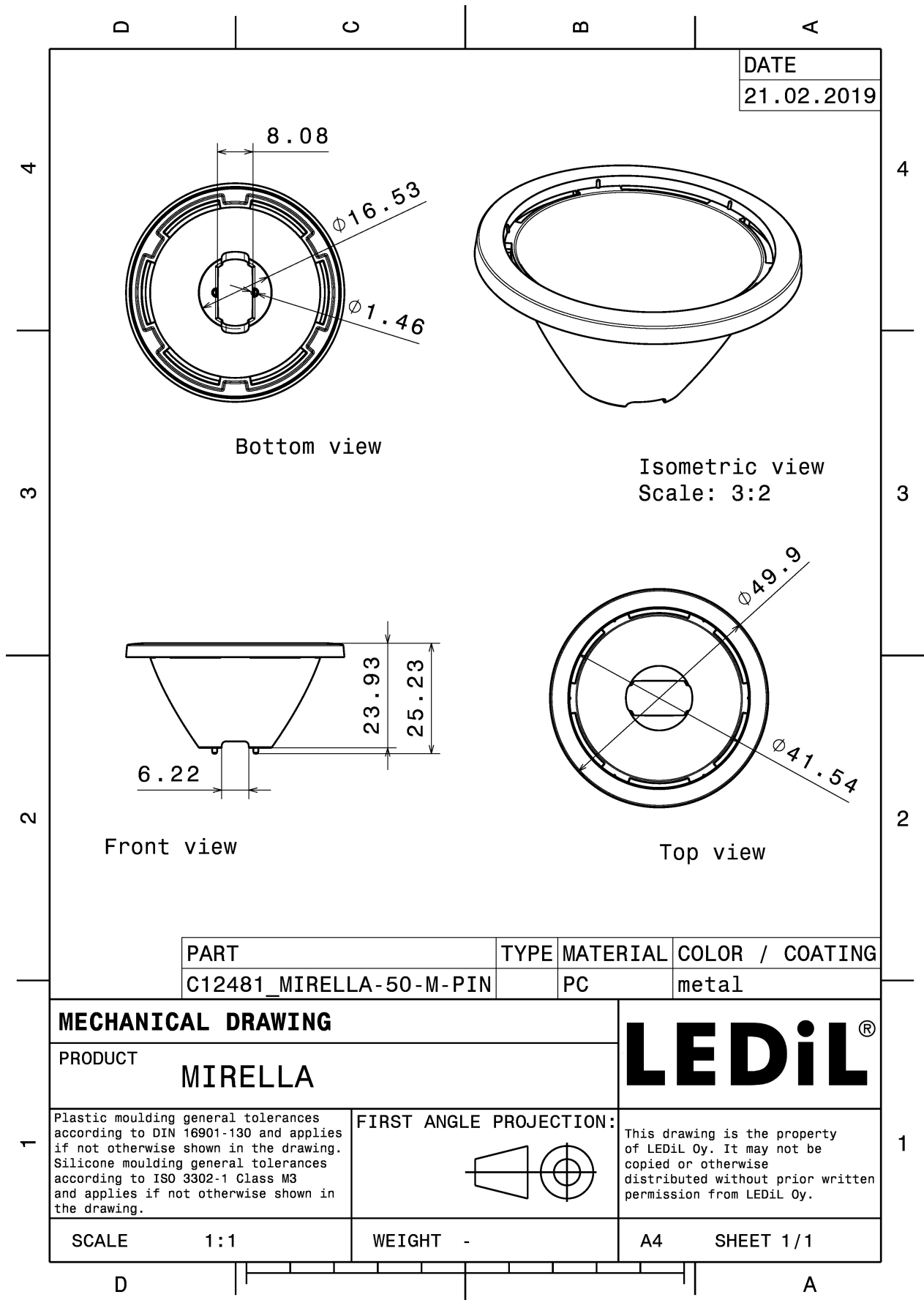



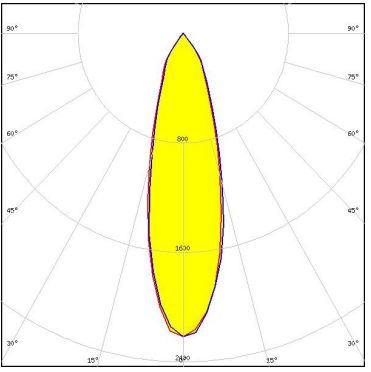

ORDERING INFORMATION:

Component	Qty in box	MOQ	MPQ	Box weight (kg)
C12481_MIRELLA-50-M-PIN » Box size: 480 x 280 x 300 mm	336	112	28	3.1

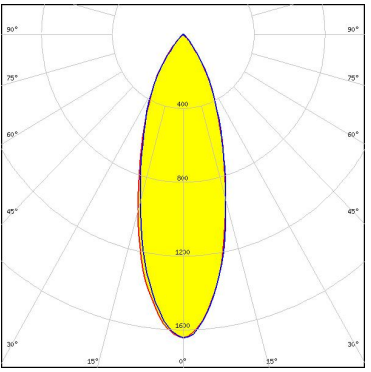

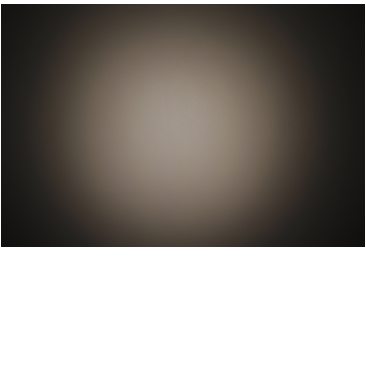
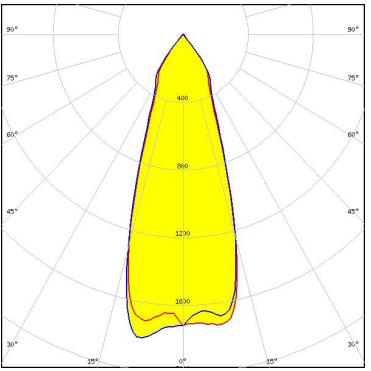
See also our general installation guide: www.ledil.com/installation_guide

PHOTOMETRIC DATA (MEASURED):

<p></p> <p>LED SM4 FWHM / FWTM 29.0° / 68.0° Efficiency 80 % Peak intensity 2.2 cd/m LEDs/each optic 1 Light colour White Required components: C13333_MIRELLA-CL</p>		
<p></p> <p>LED SM4 FWHM / FWTM 35.0° / 73.0° Efficiency 78 % Peak intensity 1.7 cd/m LEDs/each optic 1 Light colour White Required components: C12479_MIRELLA-DL</p>		
<p></p> <p>LED MHB-A/B FWHM / FWTM 35.0° / 76.0° Efficiency 83 % Peak intensity 1.8 cd/m LEDs/each optic 1 Light colour White Required components: C12479_MIRELLA-DL</p>		
<p></p> <p>LED MHB-A/B FWHM / FWTM 28.0° / 80.0° Efficiency 88 % Peak intensity 2.5 cd/m LEDs/each optic 1 Light colour White Required components:</p>		

PHOTOMETRIC DATA (MEASURED):



LED MHB-A/B
 FWHM / FWTM 34.0° / 78.0°
 Efficiency 83 %
 Peak intensity 2 cd/m
 LEDs/each optic 1
 Light colour White
 Required components:
 C13333_MIRELLA-CL

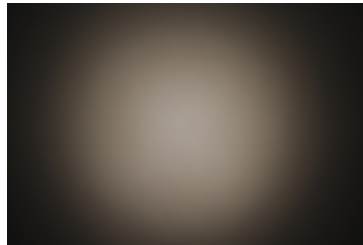

LED XHP50
 FWHM / FWTM 32.0° / 74.0°
 Efficiency 86 %
 Peak intensity 1.8 cd/m
 LEDs/each optic 1
 Light colour White
 Required components:
 C12479_MIRELLA-DL

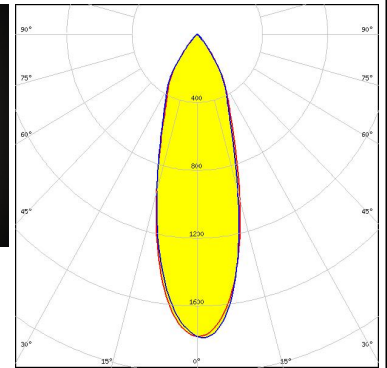
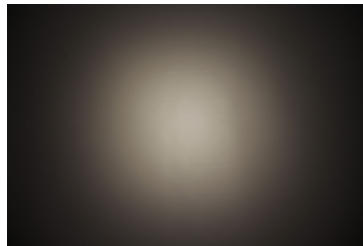

LED XHP50
 FWHM / FWTM 37.0° / 78.0°
 Efficiency 83 %
 Peak intensity 1.4 cd/m
 LEDs/each optic 1
 Light colour White
 Required components:
 C13723_MIRELLA-RZL

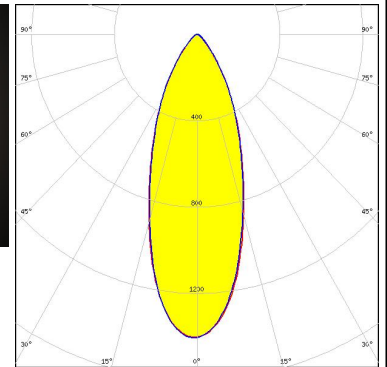
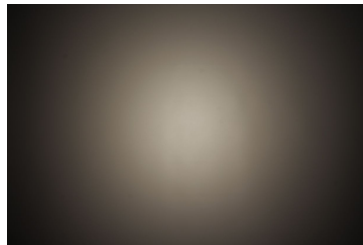

LED XHP50
 FWHM / FWTM 25.0° / 77.0°
 Efficiency 90 %
 Peak intensity 2.5 cd/m
 LEDs/each optic 1
 Light colour White
 Required components:

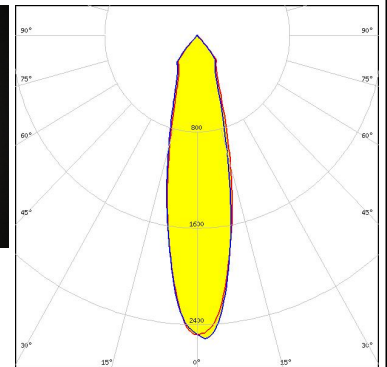
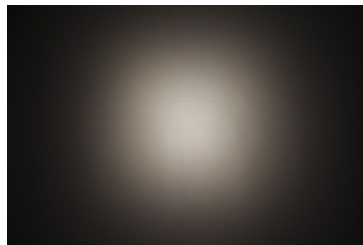

PHOTOMETRIC DATA (MEASURED):



LED XHP50
 FWHM / FWTM 32.0° / 76.0°
 Efficiency 85 %
 Peak intensity 1.9 cd/lm
 LEDs/each optic 1
 Light colour White
 Required components:
 C13333_MIRELLA-CL

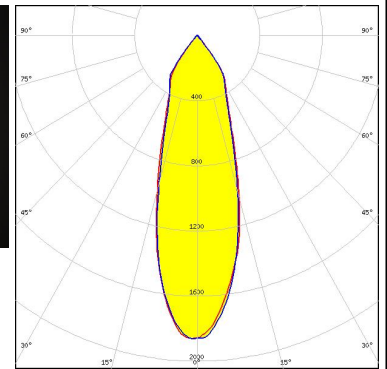
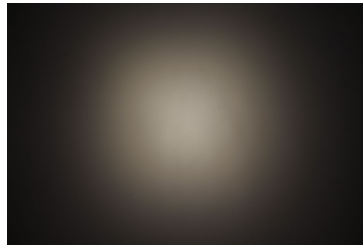

LED XM-L
 FWHM / FWTM 24.0° / 56.0°
 Efficiency 89 %
 Peak intensity 2.9 cd/lm
 LEDs/each optic 1
 Light colour White
 Required components:

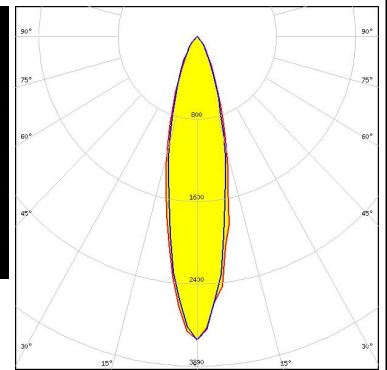

LED XM-L
 FWHM / FWTM 35.0° / 76.0°
 Efficiency 80 %
 Peak intensity 1.5 cd/lm
 LEDs/each optic 1
 Light colour White
 Required components:
 C12479_MIRELLA-DL

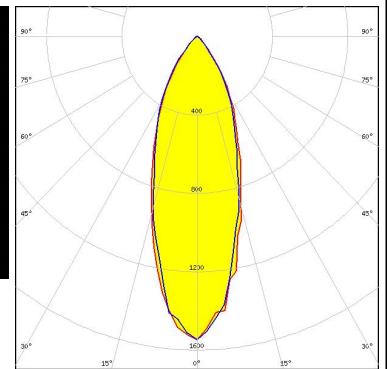
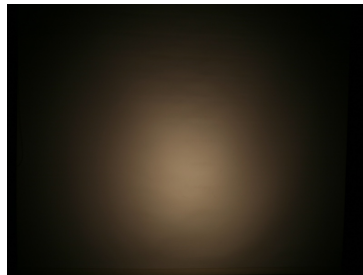

LED XM-L
 FWHM / FWTM 28.0° / 72.0°
 Efficiency 84 %
 Peak intensity 2.3 cd/lm
 LEDs/each optic 1
 Light colour White
 Required components:
 C13333_MIRELLA-CL

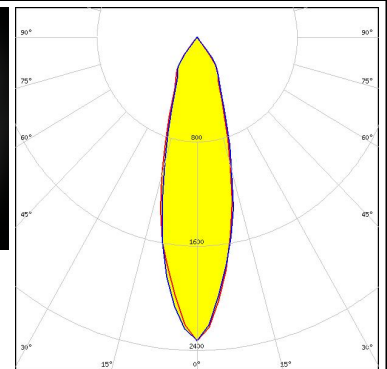

PHOTOMETRIC DATA (MEASURED):



LED XM-L RGB
 FWHM / FWTM 37.0° / 76.0°
 Efficiency 83 %
 Peak intensity 1.5 cd/lm
 LEDs/each optic 1
 Light colour White
 Required components:
 C13723_MIRELLA-RZL

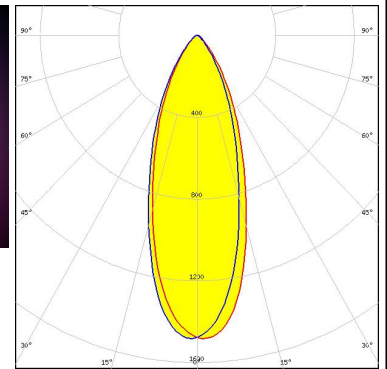
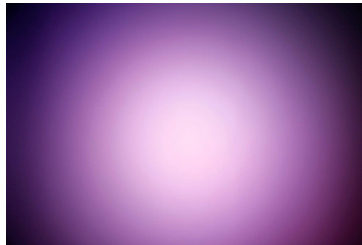

LED XM-L2
 FWHM / FWTM 22.0° / 58.0°
 Efficiency 91 %
 Peak intensity 3.1 cd/lm
 LEDs/each optic 1
 Light colour White
 Required components:

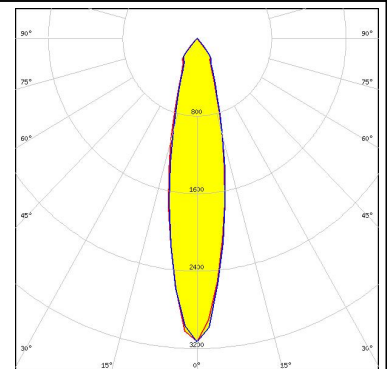

LED XM-L2
 FWHM / FWTM 33.0° / 74.0°
 Efficiency 82 %
 Peak intensity 1.9 cd/lm
 LEDs/each optic 1
 Light colour White
 Required components:
 C12479_MIRELLA-DL

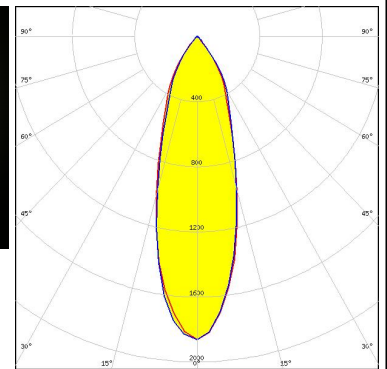
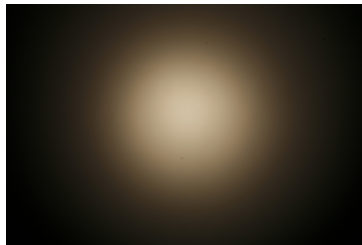

LED XP-G
 FWHM / FWTM 24.0° / 53.0°
 Efficiency 86 %
 Peak intensity 3.3 cd/lm
 LEDs/each optic 1
 Light colour White
 Required components:

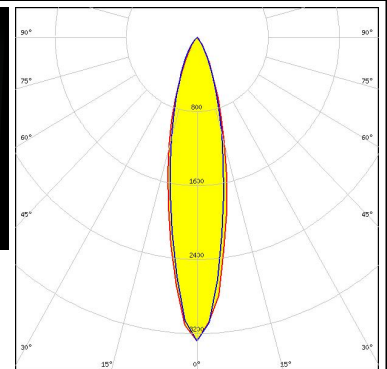

PHOTOMETRIC DATA (MEASURED):



LED XP-G
 FWHM / FWTM 34.0° / 74.0°
 Efficiency 81 %
 Peak intensity 1.6 cd/lm
 LEDs/each optic 1
 Light colour White
 Required components:
 C12479_MIRELLA-DL

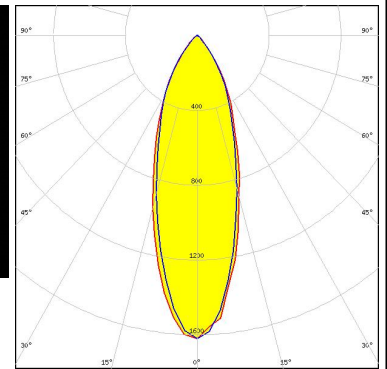

LED XP-G
 FWHM / FWTM 24.0° / 68.0°
 Efficiency 83 %
 Peak intensity 2.7 cd/lm
 LEDs/each optic 1
 Light colour White
 Required components:
 C13333_MIRELLA-CL

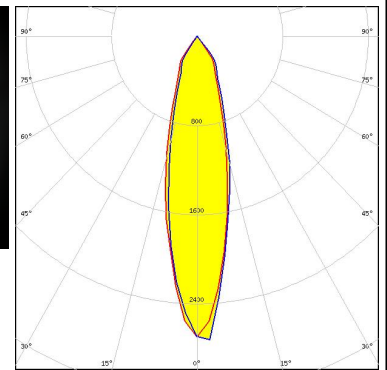
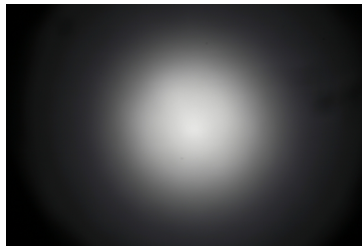

LED XP-G2
 FWHM / FWTM 30.0° / 74.0°
 Efficiency 83 %
 Peak intensity 2 cd/lm
 LEDs/each optic 1
 Light colour White
 Required components:
 C12479_MIRELLA-DL



LED XP-G2
 FWHM / FWTM 22.0° / 76.0°
 Efficiency 88 %
 Peak intensity 2.9 cd/lm
 LEDs/each optic 1
 Light colour White
 Required components:



PHOTOMETRIC DATA (MEASURED):

CREE 

LED XP-L HI
 FWHM / FWTM 17.0° / 48.0°
 Efficiency 88 %
 Peak intensity 4.5 cd/lm
 LEDs/each optic 1
 Light colour White
 Required components:

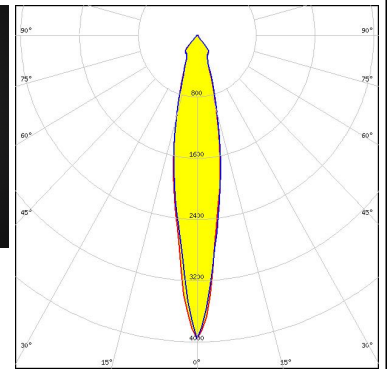

CREE 

LED XT-E
 FWHM / FWTM 32.0° / 73.0°
 Efficiency 78 %
 Peak intensity 1.8 cd/lm
 LEDs/each optic 1
 Light colour White
 Required components:
 C12479_MIRELLA-DL

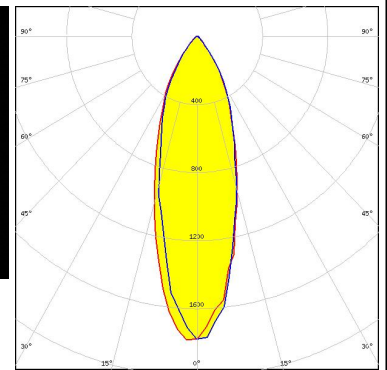
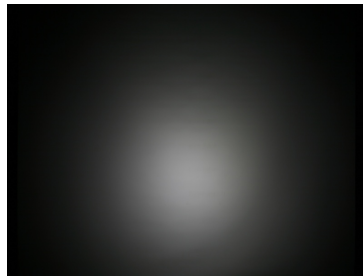

CREE 

LED XT-E
 FWHM / FWTM 23.0° / 51.0°
 Efficiency 85 %
 Peak intensity 3.4 cd/lm
 LEDs/each optic 1
 Light colour White
 Required components:

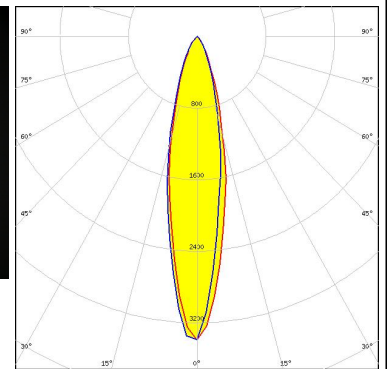

CREE 

LED XT-E
 FWHM / FWTM 22.0° / 64.0°
 Efficiency 81 %
 Peak intensity 2.9 cd/lm
 LEDs/each optic 1
 Light colour White
 Required components:
 C13333_MIRELLA-CL

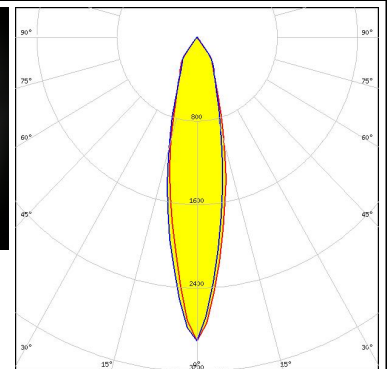
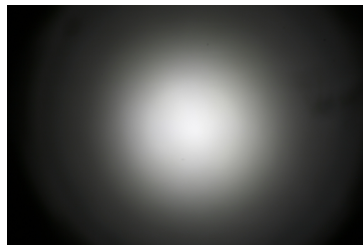

PHOTOMETRIC DATA (MEASURED):

LUMILEDS

LED LUXEON 5050 Round LES
 FWHM / FWTM 22.0° / 59.0°
 Efficiency 90 %
 Peak intensity 3.2 cd/lm
 LEDs/each optic 1
 Light colour White
 Required components:

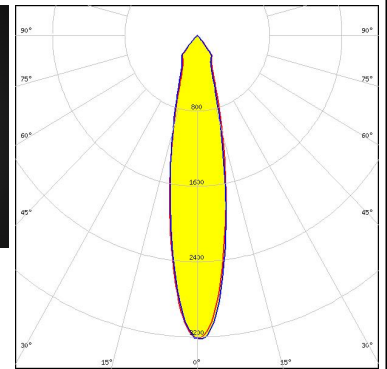
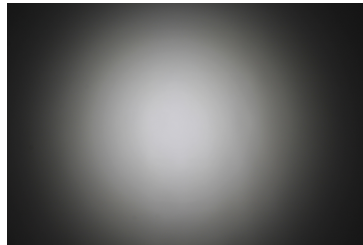

LUMILEDS

LED LUXEON A
 FWHM / FWTM 34.0° / 75.0°
 Efficiency 80 %
 Peak intensity 1.6 cd/lm
 LEDs/each optic 1
 Light colour White
 Required components:
 C12479_MIRELLA-DL

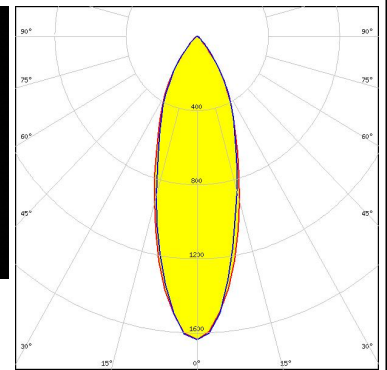
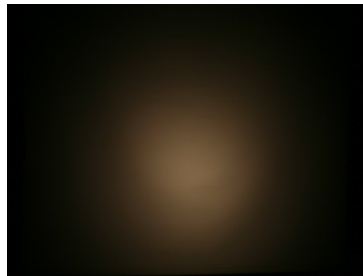

LUMILEDS

LED LUXEON A
 FWHM / FWTM 24.0° / 69.0°
 Efficiency 84 %
 Peak intensity 2.6 cd/lm
 LEDs/each optic 1
 Light colour White
 Required components:
 C13333_MIRELLA-CL

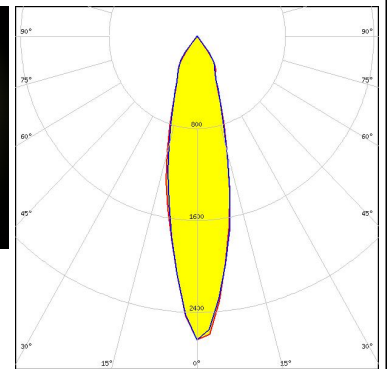
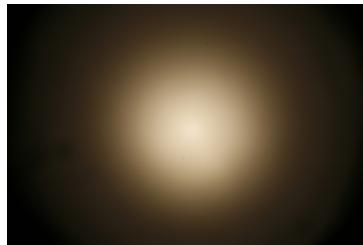





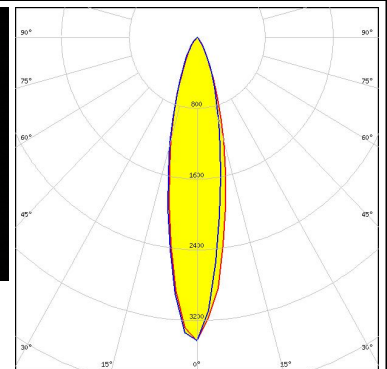

LUMILEDS

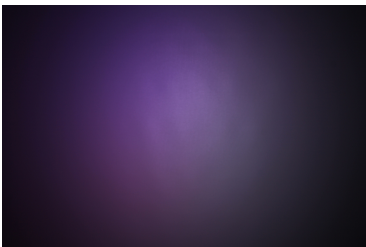
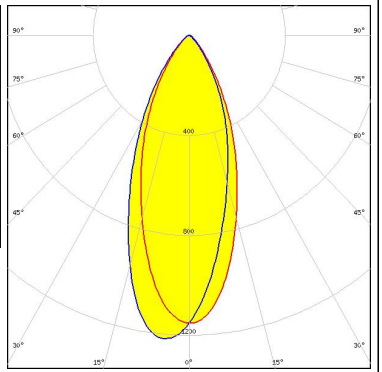

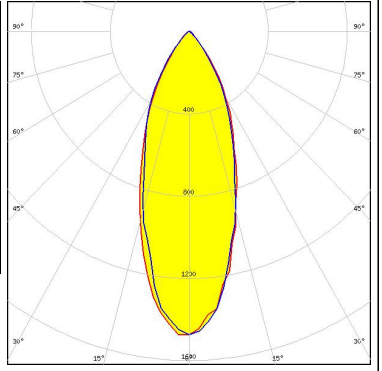
LED LUXEON A
 FWHM / FWTM 22.0° / 52.0°
 Efficiency 87 %
 Peak intensity 3.4 cd/lm
 LEDs/each optic 1
 Light colour White
 Required components:

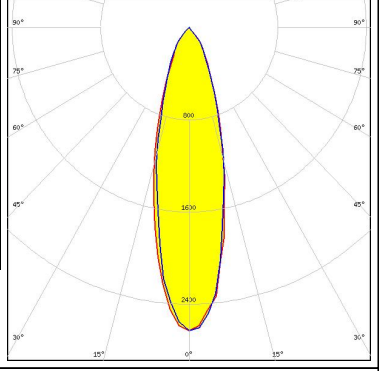

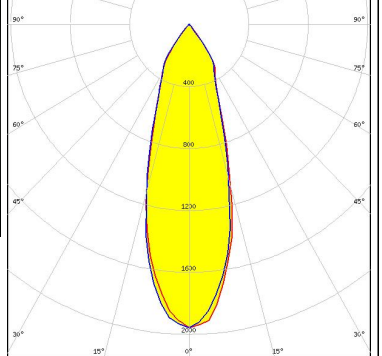
PHOTOMETRIC DATA (MEASURED):

<p>LUMILEDS</p> <p>LED LUXEON C</p> <p>FWHM / FWTM 39.0° / 79.0°</p> <p>Efficiency 74 %</p> <p>Peak intensity 1.2 cd/lm</p> <p>LEDs/each optic 4</p> <p>Light colour RGBW</p> <p>Required components: C13723_MIRELLA-RZL</p>		
<p>LUMILEDS</p> <p>LED LUXEON M/MX</p> <p>FWHM / FWTM 38.0° / 78.0°</p> <p>Efficiency 81 %</p> <p>Peak intensity 1.5 cd/lm</p> <p>LEDs/each optic 1</p> <p>Light colour White</p> <p>Required components: C12479_MIRELLA-DL</p>		
<p>LUMILEDS</p> <p>LED LUXEON M/MX</p> <p>FWHM / FWTM 24.0° / 63.0°</p> <p>Efficiency 87 %</p> <p>Peak intensity 2.6 cd/lm</p> <p>LEDs/each optic 1</p> <p>Light colour White</p> <p>Required components:</p>		
<p>LUMILEDS</p> <p>LED LUXEON M/MX</p> <p>FWHM / FWTM 33.0° / 74.0°</p> <p>Efficiency 84 %</p> <p>Peak intensity 2 cd/lm</p> <p>LEDs/each optic 1</p> <p>Light colour White</p> <p>Required components: C13333_MIRELLA-CL</p>		

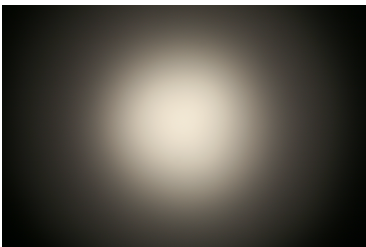
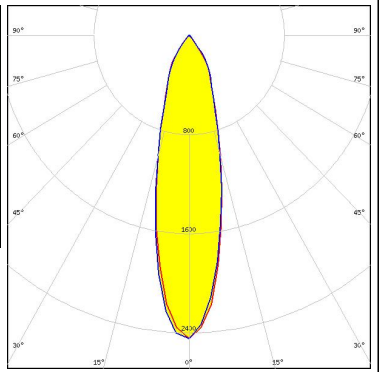
PHOTOMETRIC DATA (MEASURED):

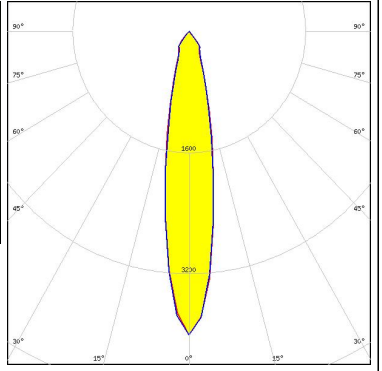
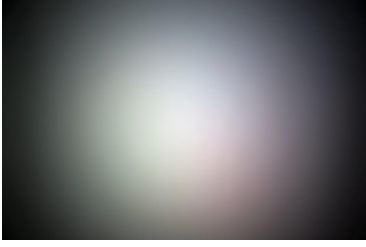
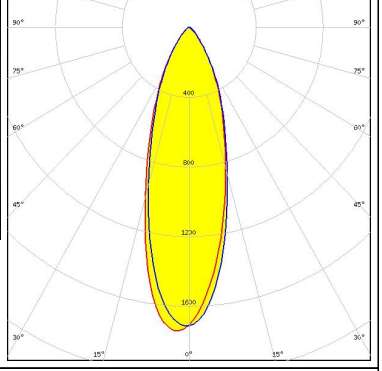
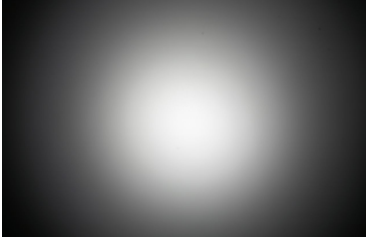
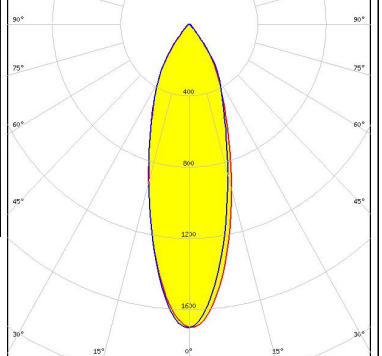
<p>LUMILEDS</p> <p>LED LUXEON MZ FWHM / FWTM 27.0° / 69.0° Efficiency 84 % Peak intensity 2.4 cd/lm LEDs/each optic 1 Light colour White Required components: C12479_MIRELLA-DL</p>		
<p>LUMILEDS</p> <p>LED LUXEON MZ FWHM / FWTM 20.0° / 47.0° Efficiency 88 % Peak intensity 4 cd/lm LEDs/each optic 1 Light colour White Required components:</p>		
<p>LUMILEDS</p> <p>LED LUXEON Z FWHM / FWTM 31.0° / 71.0° Efficiency 83 % Peak intensity 1.7 cd/lm LEDs/each optic 4 Light colour RGBW Required components: C13723_MIRELLA-RZL</p>		
<p>NICHIA</p> <p>LED NS9x383 FWHM / FWTM 32.0° / 74.0° Efficiency 83 % Peak intensity 1.7 cd/lm LEDs/each optic 1 Light colour White Required components: C12479_MIRELLA-DL</p>		

PHOTOMETRIC DATA (MEASURED):



LED NS9x383
 FWHM / FWTM 24.0° / 78.0°
 Efficiency 88 %
 Peak intensity 2.5 cd/lm
 LEDs/each optic 1
 Light colour White
 Required components:

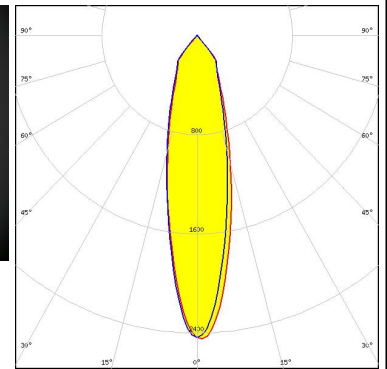

LED NV4x144A
 FWHM / FWTM 27.0° / 73.0°
 Efficiency 89 %
 Peak intensity 2.5 cd/lm
 LEDs/each optic 1
 Light colour White
 Required components:

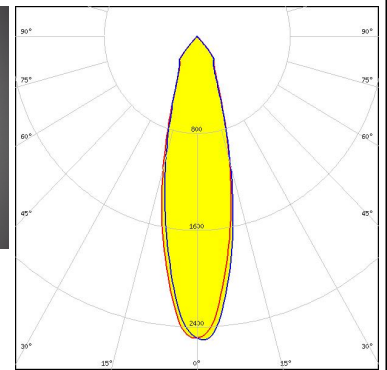
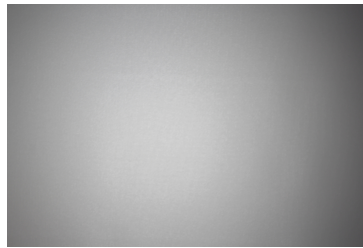



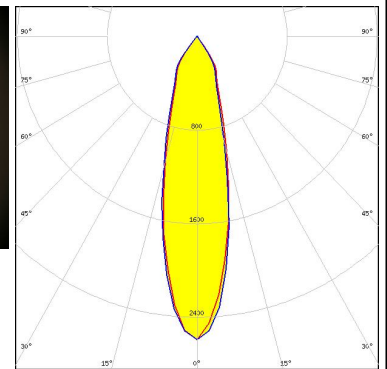

LED Duris S8
 FWHM / FWTM 26.0° / 70.0°
 Efficiency 84 %
 Peak intensity 2.6 cd/lm
 LEDs/each optic 1
 Light colour White
 Required components:
 C13333_MIRELLA-CL

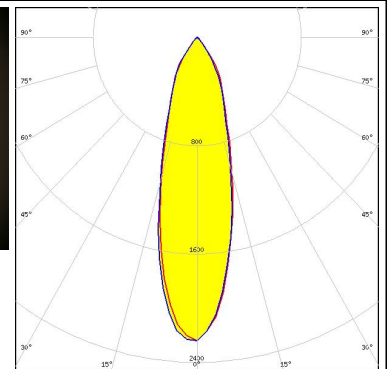
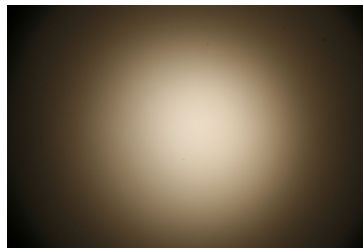

LED Duris S8
 FWHM / FWTM 28.0° / 69.0°
 Efficiency 84 %
 Peak intensity 2.2 cd/lm
 LEDs/each optic 1
 Light colour White
 Required components:
 C12479_MIRELLA-DL

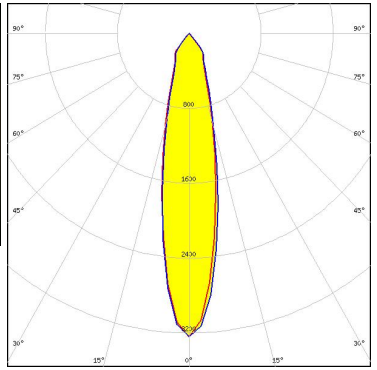

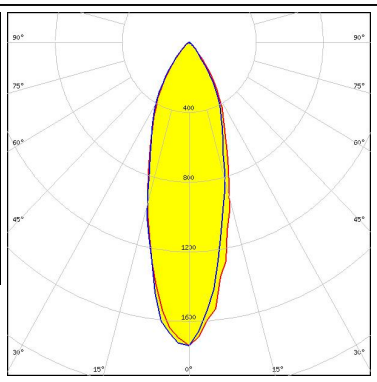
PHOTOMETRIC DATA (MEASURED):

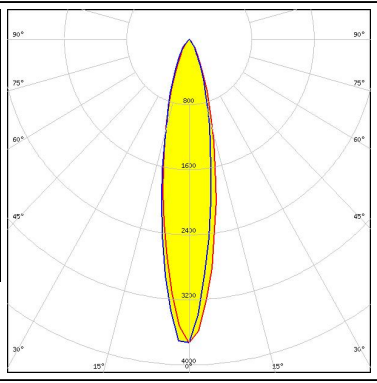
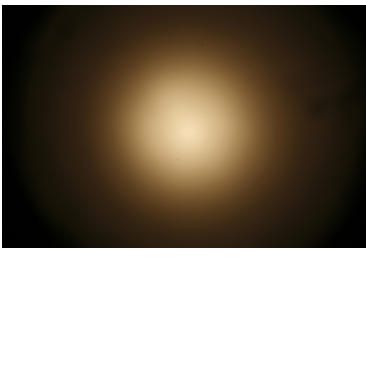
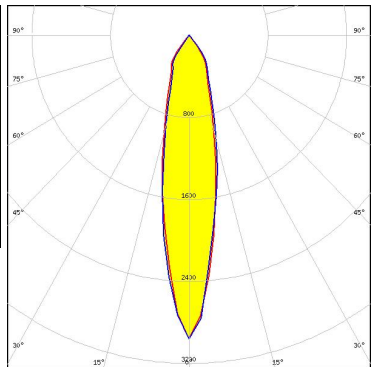
<p>OSRAM Opto Semiconductors</p> <p>LED Duris S8</p> <p>FWHM / FWTM 22.0° / 58.0°</p> <p>Efficiency 88 %</p> <p>Peak intensity 3.2 cd/lm</p> <p>LEDs/each optic 1</p> <p>Light colour White</p> <p>Required components:</p>		
<p>OSRAM Opto Semiconductors</p> <p>LED OSLOM Square EC</p> <p>FWHM / FWTM 32.0° / 75.0°</p> <p>Efficiency 79 %</p> <p>Peak intensity 1.7 cd/lm</p> <p>LEDs/each optic 1</p> <p>Light colour White</p> <p>Required components: C12479_MIRELLA-DL</p>		
<p>OSRAM Opto Semiconductors</p> <p>LED OSLOM Square EC</p> <p>FWHM / FWTM 22.0° / 49.0°</p> <p>Efficiency 84 %</p> <p>Peak intensity 3.4 cd/lm</p> <p>LEDs/each optic 1</p> <p>Light colour White</p> <p>Required components:</p>		
<p>OSRAM Opto Semiconductors</p> <p>LED OSLOM Square EC</p> <p>FWHM / FWTM 22.0° / 67.0°</p> <p>Efficiency 83 %</p> <p>Peak intensity 3 cd/lm</p> <p>LEDs/each optic 1</p> <p>Light colour White</p> <p>Required components: C13333_MIRELLA-CL</p>		

PHOTOMETRIC DATA (MEASURED):

OSRAM

Opto Semiconductors

LED Ostar-SMT RGB
 FWHM / FWTM 34.0° / 74.0°
 Efficiency 83 %
 Peak intensity 1.6 cd/lm
 LEDs/each optic 1
 Light colour White
 Required components:
 C13723_MIRELLA-RZL

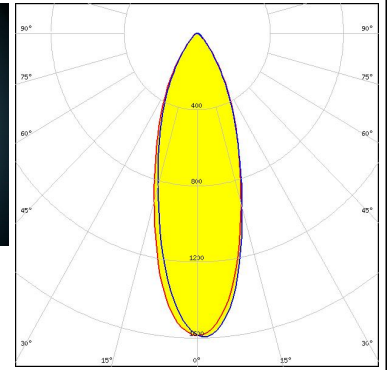
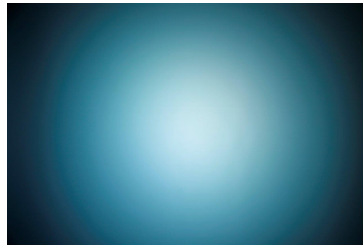

SAMSUNG

LED LH508A
 FWHM / FWTM 24.0° / 78.0°
 Efficiency 88 %
 Peak intensity 2.4 cd/lm
 LEDs/each optic 1
 Light colour White
 Required components:

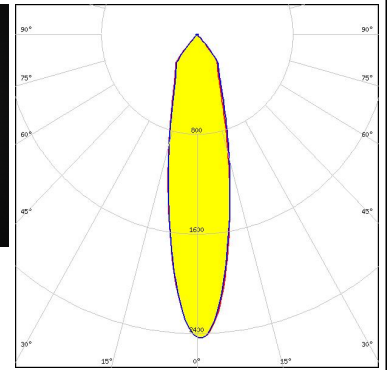
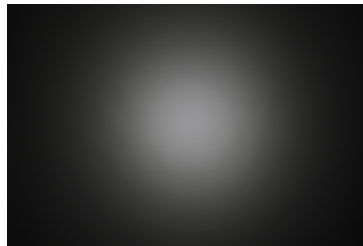

SEOUL SEMICONDUCTOR

LED F50360 (RGB)
 FWHM / FWTM 33.0° / 76.0°
 Efficiency 82 %
 Peak intensity 1.8 cd/lm
 LEDs/each optic 1
 Light colour White
 Required components:
 C13723_MIRELLA-RZL

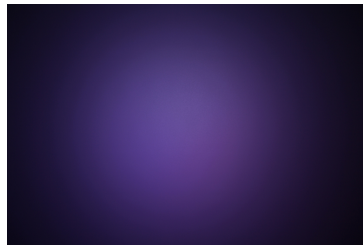

PHOTOMETRIC DATA (SIMULATED):



LED XHP35 HD
 FWHM / FWTM 28.0° / 77.0°
 Efficiency 92 %
 Peak intensity 2.5 cd/lm
 LEDs/each optic 1
 Light colour White
 Required components:

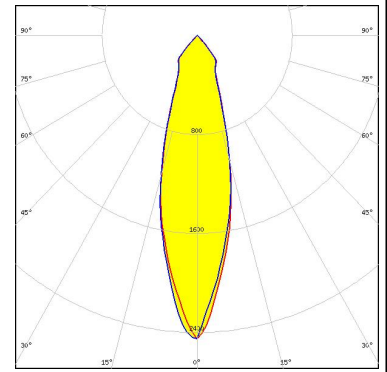

LED LUXEON 5258
 FWHM / FWTM 23.0° / 45.0°
 Efficiency 91 %
 Peak intensity 3.8 cd/lm
 LEDs/each optic 1
 Light colour White
 Required components:

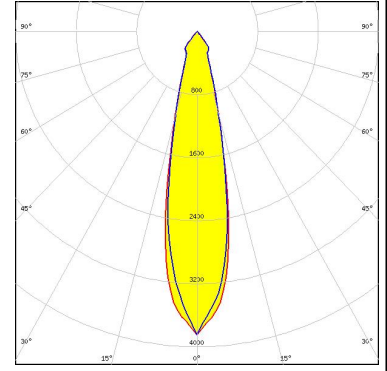

OSRAM Opto Semiconductors
 LED OSCONIQ P 7070
 FWHM / FWTM 29.0° / 70.0°
 Efficiency 87 %
 Peak intensity 2.3 cd/lm
 LEDs/each optic 1
 Light colour White
 Required components:
 C13333_MIRELLA-CL

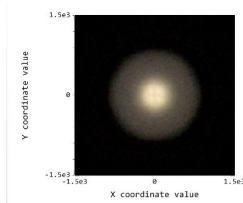

Detector image: illuminance
 01 = 0001
 Detector: 1 - 000 Surface 1
 Size: 1000x1000 µm
 Peak Intensity: 2.300000 cd/m²
 Total Power: 5.7120000 Lumens
 OSRAM_MIRELLA-50-M-PIN_C13333_MIRELLA-CL Configuration: 1 of 1

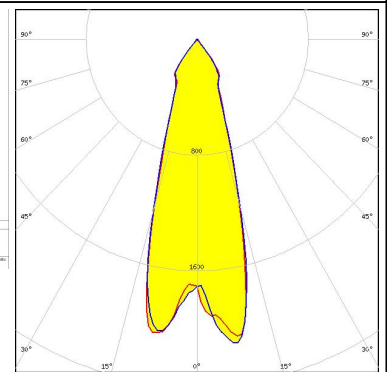

OSRAM Opto Semiconductors
 LED OSCONIQ P 7070
 FWHM / FWTM 31.0° / 72.0°
 Efficiency 88 %
 Peak intensity 2.4 cd/lm
 LEDs/each optic 1
 Light colour White
 Required components:
 C12479_MIRELLA-DL

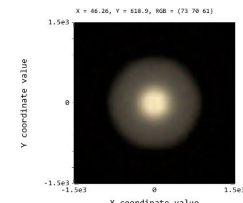

Detector image: illuminance
 01 = 0001
 Detector: 1 - 000 Surface 1
 Size: 1000x1000 µm
 Peak Intensity: 2.400000 cd/m²
 Total Power: 6.7128000 Lumens
 OSRAM_MIRELLA-50-M-PIN_C12479_MIRELLA-DL Configuration: 1 of 1

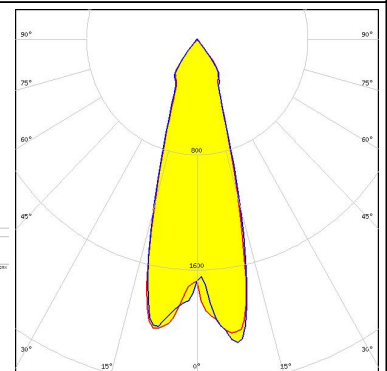

PHOTOMETRIC DATA (SIMULATED):

OSRAM

Opto Semiconductors

LED OSCONIQ P 7070
 FWHM / FWTM 26.0° / 63.0°
 Efficiency 91 %
 Peak intensity 2.9 cd/lm
 LEDs/each optic 1
 Light colour White
 Required components:

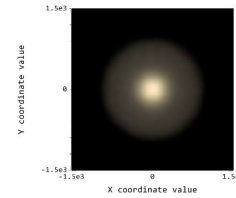

Detector Image: Illuminance

01-11-2018
 Detector: s_1636 surface: 1
 Size: 1000.000 x 1.000.000 x 0.000000
 Peak Illuminance: 0.000000 Lux/m²
 Total flux: 0.000000 Lumens

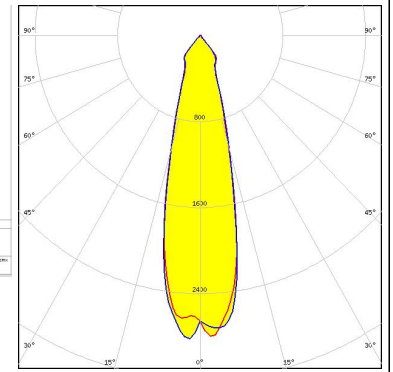

SAMSUNG

LED LH351D
 FWHM / FWTM 26.0° / 54.0°
 Efficiency 90 %
 Peak intensity 3 cd/lm
 LEDs/each optic 1
 Light colour White
 Required components:

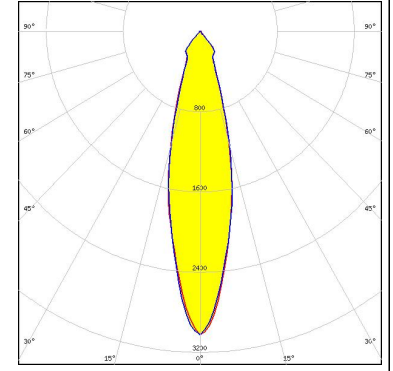

SEOUL SEMICONDUCTOR

LED Z8Y22P
 FWHM / FWTM 19.0° / 44.0°
 Efficiency 89 %
 Peak intensity 4.3 cd/lm
 LEDs/each optic 1
 Light colour White
 Required components:

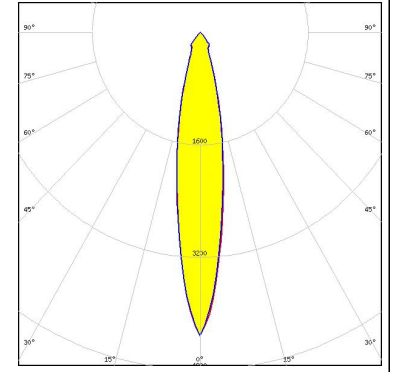

GENERAL INFORMATION:

NOTE: The typical beam angle will be changed by different color, chip size and chip position tolerance. The typical total beam angle is the full angle measured where the luminous intensity is half of the peak value.

MATERIALS:

As part of our continuous research and improvement processes, and to ensure the best possible quality and availability of our products, LEDiL reserves the right to change material grades without notice.

PRODUCT DATA USER AGREEMENT AND DISCLAIMER:

The measured data in the provided downloadable LEDiL Product Datasheets and Mechanical 2D-Drawings is rounded and provided as reference for planning. LEDiL Oy's optical specifications have been verified by conducting performance testing of the products in accordance with the company's quality system. The reported data are averaged results of multiple measurements with typical variation. LEDiL Oy reserves the right to without prior notification make changes and improvements to its products.

LEDiL Oy assumes neither warranty, nor guarantee nor any other liability of any kind for the contents and correctness of the provided data. The provided data has been generated with highest diligence but the provided data may in reality not represent the complete possible variation range of all intrinsic parameters. Therefore, in certain cases a deviation from the provided data could occur.

LEDiL Oy reserves the right to undertake technical changes of its products without further notification which could lead to changes in the provided data. LEDiL Oy assumes no liability of any kind for the possible deviation from any provided data or any other damage resulting from the usage of the provided data.

The user agrees to this disclaimer and user agreement with the download or usage of the provided files.

LEDiL Oy

Joensuunkatu 13
FI-24240 SALO
Finland

LEDiL Inc.

228 West Page Street
Suite D
Sycamore IL 60178
USA

Ledil Optics Technology (Shenzhen) Co., Ltd.

405 , Block B
Casic Motor Building
Shenzhen 518057
P.R.CHINA

Local sales and technical support

[www.ledil.com/
where_to_buy](http://www.ledil.com/where_to_buy)

Shipping locations

Salo, Finland
Hong Kong, China

Distribution Partners

[www.ledil.com/
where_to_buy](http://www.ledil.com/where_to_buy)