

ANNA-B112

Stand-alone Bluetooth 5 low energy module

Data sheet

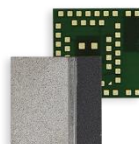

Abstract

This technical data sheet describes the ultra-compact ANNA-B112 stand-alone Bluetooth® 5 low energy module packed into a System-in-Package design. Despite the small size, ANNA-B112 offers an internal antenna option. With embedded Bluetooth low energy stack and u-connectXpress software, this SiP module is tailored for OEMs who wish to have the shortest time-to-market. ANNA-B112 offers full flexibility, and the OEMs can embed their own application on top of the integrated Bluetooth low energy stack using Nordic SDK or Arm® Mbed™ integrated development environment (IDE).

Document information

Title	ANNA-B112	
Subtitle	Stand-alone Bluetooth 5 low energy module	
Document type	Data sheet	
Document number	UBX-18011707	
Revision and date	R12	14-Mar-2023
Disclosure Restriction	C1-Public	

Product status	Corresponding content status	
Functional sample	Draft	For functional testing. Revised and supplementary data will be published later.
In development / Prototype	Objective specification	Target values. Revised and supplementary data will be published later.
Engineering sample	Advance information	Data based on early testing. Revised and supplementary data will be published later.
Initial production	Early production information	Data from product verification. Revised and supplementary data may be published later.
Mass production / End of life	Production information	Document contains the final product specification.

This document applies to the following products:

Product name	Type number	u-connectXpress software version	Hardware version	PCN reference	Product status
ANNA-B112	ANNA-B112-00B-00	1.0.0	03	N/A	Mass production
ANNA-B112	ANNA-B112-01B-00	2.0.0	03	N/A	Mass production
ANNA-B112	ANNA-B112-70B-00	N/A	03	N/A	Mass production
ANNA-B112	ANNA-B112-02B-00	4.0.0	03	N/A	Mass production

u-blox or third parties may hold intellectual property rights in the products, names, logos, and designs included in this document. Copying, reproduction, or modification of this document or any part thereof is only permitted with the express written permission of u-blox. Disclosure to third parties is permitted for clearly public documents only.

The information contained herein is provided "as is" and u-blox assumes no liability for its use. No warranty, either express or implied, is given, including but not limited to, with respect to the accuracy, correctness, reliability, and fitness for a particular purpose of the information. This document may be revised by u-blox at any time without notice. For the most recent documents, visit www.u-blox.com.

Copyright © u-blox AG.

Contents

Document information	2
Contents	3
1 Functional description	5
1.1 Overview	5
1.2 Product features	6
1.3 Block diagram	7
1.4 Product description	8
1.5 Software options	8
1.5.1 u-connectXpress software	9
1.5.2 Open CPU	9
1.6 Bluetooth device address	9
2 Interfaces	10
2.1 Power management	10
2.1.1 Module supply input (VCC)	10
2.2 RF antenna interfaces	10
2.2.1 2.4 GHz Bluetooth low energy (ANT)	10
2.2.2 Near Field Communication (NFC)	10
2.3 Low Power Oscillator interface	10
2.4 System functions	11
2.4.1 Module power-on	11
2.4.2 Module power-off	11
2.4.3 Standby mode	11
2.4.4 Sleep mode	12
2.4.5 Module reset	12
2.4.6 Real Time Counter (RTC)	12
2.5 Serial interfaces	12
2.5.1 Asynchronous serial interface (UART)	13
2.5.2 Serial peripheral interface (SPI)	13
2.5.3 I2C interface	13
2.5.4 I2S interface	14
2.6 GPIO	14
2.6.1 PWM	15
2.7 Analog interfaces	15
2.7.1 ADC	15
2.7.2 Comparator	15
2.7.3 Low power comparator	15
2.7.4 Analog pin options	15
2.8 u-connectXpress software features	16
2.8.1 u-blox Serial Port Service (SPS)	16
2.8.2 System status signals	16
2.8.3 System control signals	16

2.8.4	UART signals.....	16
2.8.5	IO signals.....	17
2.9	Debug interfaces.....	17
2.9.1	SWD.....	17
2.9.2	Trace – Serial Wire Viewer.....	17
3	Pin definition.....	18
3.1	Open CPU pin assignment.....	18
3.2	u-connectXpress pin assignment.....	21
4	Electrical specifications.....	24
4.1	Absolute maximum ratings.....	24
4.1.1	Maximum ESD ratings.....	24
4.2	Operating conditions.....	24
4.2.1	Operating temperature range.....	24
4.2.2	Supply/Power pins.....	25
4.2.3	Current consumption.....	25
4.2.4	RF performance.....	25
4.2.5	Throughput characteristics.....	26
4.2.6	Latency.....	26
4.2.7	ANNA-B112 radiation patterns.....	27
4.2.8	RESET_N pin.....	29
4.2.9	Digital pins.....	29
5	Qualifications and approvals.....	30
5.1	Bluetooth qualification.....	30
6	Mechanical specifications.....	31
7	Product handling.....	32
7.1	Packaging.....	32
7.2	Reels.....	32
7.3	Tapes.....	33
7.4	Moisture sensitivity levels.....	34
7.5	Reflow soldering.....	34
7.6	ESD precautions.....	34
8	Marking and ordering information.....	35
8.1	Product marking.....	35
8.2	Product identifiers.....	36
8.3	Identification codes.....	36
8.4	Ordering information.....	36
	Appendix.....	37
A	Glossary.....	37
	Related documents.....	38
	Revision history.....	38
	Contact.....	39

1 Functional description

1.1 Overview

ANNA-B112 is an ultra-small, high-performing, standalone Bluetooth low energy module. The System-in-Package (SiP) module features Bluetooth 5, a powerful Arm® Cortex®-M4 microprocessor with FPU, with state-of-the-art power performance.

ANNA-B112 is delivered with u-connectXpress software that provides support for u-blox Bluetooth Low Energy Serial Port Service, GATT client and server, beacons, NFC™, and simultaneous peripheral and central roles – all configurable from a host by using AT commands.

The module supports two alternative antenna implementations. Utilize the integrated internal antenna together with an external antenna tuning strip, or optionally connect an external antenna to the available antenna pin during the design-in. Although the reach of external antennas can vary, the internal antenna of the module – including the external antenna strip – has a transceiver range of up to 160 m.

ANNA-B112 has full modular approval for Europe (RED), Great Britain (UKCA), US (FCC), Canada (IC / ISED RSS), Japan (MIC), Taiwan (NCC), South Korea (KCC), Australia / New Zealand (ACMA), Brazil (ANATEL), South Africa (ICASA), and China (SRRC).

1.2 Product features

	ANNA-B112	
Grade		
Automotive		
Professional	•	
Standard		
Radio		
Chip inside	nRF52832	
Bluetooth qualification	v5.0	
Bluetooth low energy	•	
Bluetooth output power EIRP [dBm] *	5 / 8	
Max range [meters] *	160 / 190	
NFC	•	
Antenna type (see footnotes)	chip / pin	
Application software		
u-connectXpress	•	
Open CPU for embedded applications		•
Interfaces		
UART	1	◆
SPI		◆
I ² C		◆
I ² S		◆
PDM and PWM		◆
GPIO pins	11	25
AD converters [number of bits]		12
Features		
AT command interface	•	
MCU (see footnotes)		M4F
RAM [kB]		64
Flash [kB]		512
Simultaneous GATT server and client	•	◆
Low Energy Serial Port Service	•	
Throughput [Mbit/s]	0.8	1.4
Maximum Bluetooth connections	7	20
Bluetooth mesh		◆
FOTA		◆
* = The different values are for use with internal/external antenna ◆ = Feature enabled by HW. The actual support depends on the open CPU application SW.		
pin = Antenna pin chip = Internal chip antenna M4F = 64 MHz Arm® Cortex-M4 with FPU		

Table 1: ANNA-B112 main features summary

1.3 Block diagram

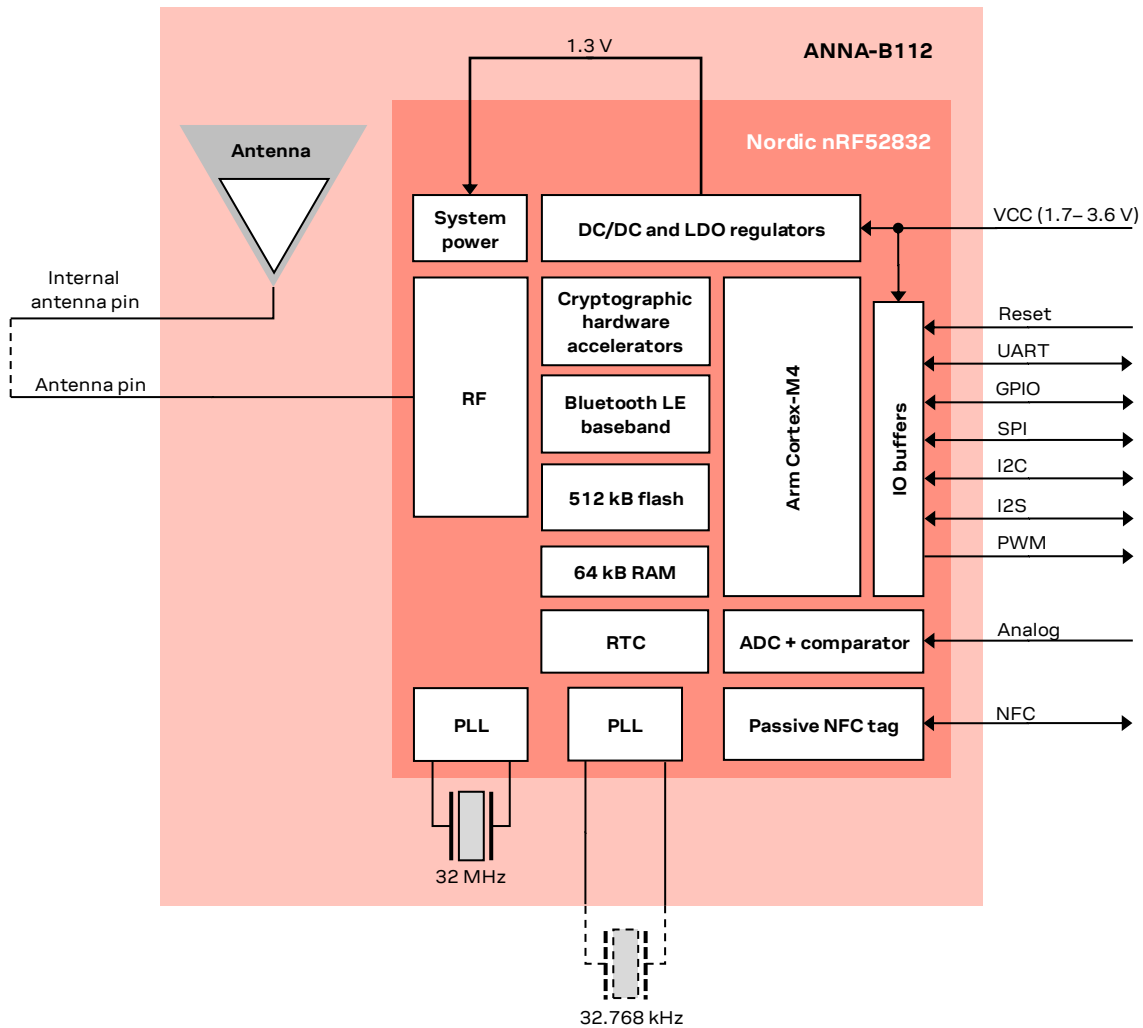

Figure 1: ANNA-B112 block diagram

The ANNA-B112 SiP module has an integrated antenna. The RF signal pin can either be connected directly to the adjacent antenna pin to use the internal antenna or routed to an external antenna or antenna connector.

The module does not have its own low power oscillator (LPO) and depending on the power supply requirement, you could connect an external LPO crystal or oscillator.

An integrated DC/DC converter is used for higher efficiency under heavy load situations. See also [Module supply input \(VCC\)](#).

1.4 Product description

Item	ANNA-B112
Bluetooth version	5.0
Band support	2.4 GHz, 40 channels
Typical conducted output power	+4 dBm
Max radiated output power with internal antenna (EIRP)	+5 dBm
Max radiated output power with external antenna (EIRP)	+9 dBm
Sensitivity (conducted)	-91 dBm
Best sensitivity with internal antenna (EIRP)	-92 dBm
Best sensitivity with external antenna (EIRP)	-96 dBm
Data rates	1 and 2 Mbps GFSK
Module size	6.5 x 6.5 x 1.2 mm

Table 2: ANNA-B112 characteristics summary

1.5 Software options

The integrated application processor of the ANNA-B112 module is an Arm Cortex-M4 with FPU that has 512 kB flash memory and 64 kB RAM. The software structure of any program running on the module can be broken down into the following components:

- Radio stack
- Bootloader (optional)
- Application

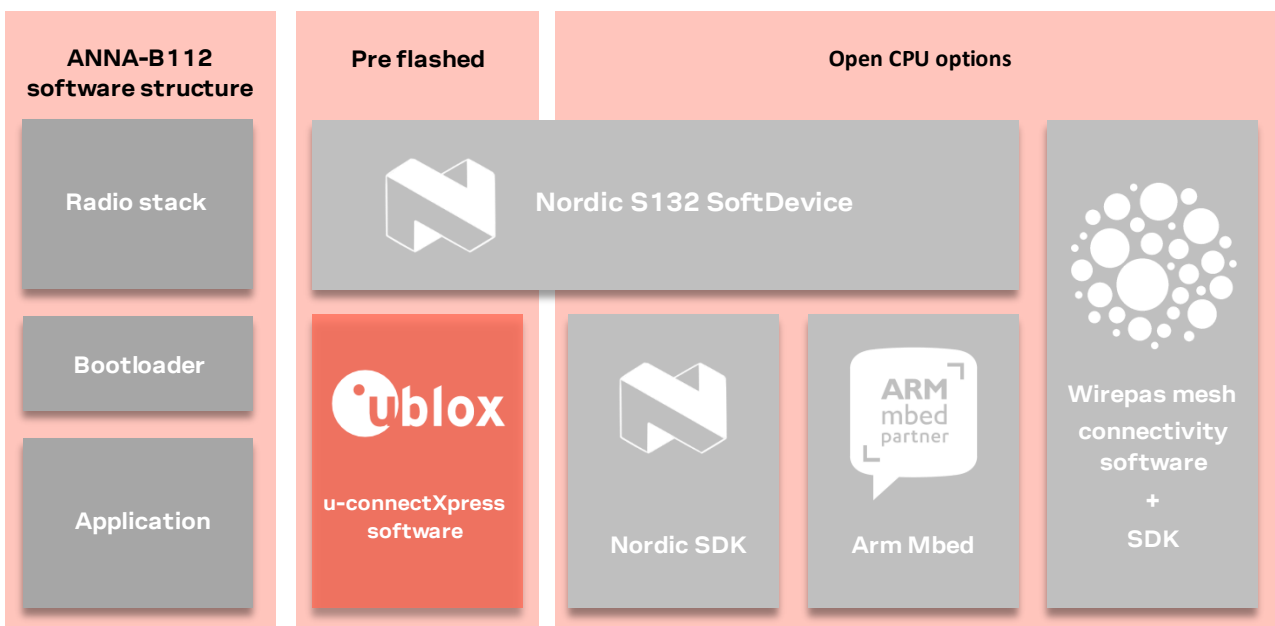

Figure 2: ANNA-B112 software structure and available software options



More information on each option, see also the ANNA-B112 system integration manual [\[1\]](#).

1.5.1 u-connectXpress software

ANNA-B1 is preflashed with u-connectXpress software.

The u-connectXpress software enables the use of the u-blox Low Energy Serial Port Service, controlled by AT commands over the UART interface. You can configure ANNA-B112 modules with AT commands or with the u-blox s-center software. The s-center evaluation software can be downloaded from the u-blox website and is available free of charge.

For information about the features, capabilities, and use of the u-blox Low Energy Serial Port Service, see also the u-connectXpress software user guide [3] and the u-connectXpress AT commands manual [2].

1.5.2 Open CPU

A custom application can be embedded in the ANNA-B112-70B module, or any ANNA-B112 variant, if the module memory is erased first. The supported development environments are described below.

nRF Connect SDK and Zephyr

The nRF Connect SDK is the most current SW development environment for nRF52-based devices. It includes a broad selection of drivers, libraries, and example applications, and is continually developed.

Nordic SDK

The Nordic nRF5 SDK provides a rich and well tested software development environment for nRF52-based devices. It includes a broad selection of drivers, libraries, and example applications.

 For new applications nRF Connect SDK and Zephyr is recommended.

Arm Mbed OS

Arm Mbed OS is an open-source, embedded operating system designed specifically for the "things" in the "Internet of Things". It includes all features to develop a connected product, including security, connectivity, an RTOS, and drivers for sensors and I/O devices. ANNA-B112 fully supports Mbed OS 5.

 For new applications nRF Connect SDK and Zephyr is recommended.

Wirepas Mesh stack

ANNA-B112 modules can also be used together with the Wirepas Mesh stack. The stack enables ANNA-B1 to be used in large-scale, mesh environments. The Wirepas mesh stack is a third-party licensed software from Wirepas.

For more information about the Wirepas mesh stack, [contact](#) your local u-blox support team or contact Wirepas directly.

1.6 Bluetooth device address

Each ANNA-B1 module is preprogrammed with a unique 48-bit Bluetooth device address.

2 Interfaces

2.1 Power management

2.1.1 Module supply input (VCC)

ANNA-B112 uses an integrated step-down converter to transform the supply voltage presented at the **VCC** pin into a stable system voltage. As a result, ANNA-B112 modules are compatible for use in battery-powered designs without the use of an additional voltage converter. You can choose one of the following board voltage converter options:

- A low-dropout (LDO) converter
- A DC/DC buck converter

ANNA-B112 automatically switches between these converters to suit the prevailing current consumption. The DC/DC converter is more efficient under high loads when the radio is active, while the LDO converter is better suited for power saving modes. It is possible to configure the module to use only the LDO mode, if needed.

2.2 RF antenna interfaces

2.2.1 2.4 GHz Bluetooth low energy (ANT)

The ANNA-B112 2.4 GHz antenna interface can be implemented in two possible ways:

- With an external antenna or antenna connector: Connect a carrier board or antenna connector to the antenna pin (**ANT**) of the module using a controlled impedance trace. The **ANT** pin has a nominal characteristic impedance of 50 Ω . For more information, see also the ANNA-B112 system integration manual [1].
- With the internal antenna: Connect the internal antenna **ANT_INT** pin to the **ANT** pin to utilize the integrated internal antenna onboard the module. Additionally, connect the **ANT_PCB**, **ANT_GND1** and **ANT_GND2** pins to an external antenna tuning strip, as described in the ANNA-B112 system integration manual [1], Appendix B.

2.2.2 Near Field Communication (NFC)

ANNA-B112 modules include a Near Field Communication interface, capable of operating as a 13.56 MHz NFC tag at a bit rate of 106 kbps. As an NFC tag, data can be read from or written to ANNA-B112 modules using an NFC reader, ANNA-B112 modules are not capable of reading other tags or initiating NFC communications. Two pins are available for connecting to an external NFC antenna: **NFC1** and **NFC2**. For more information about NFC antenna design considerations, see also the ANNA-B112 system integration manual [1].

2.3 Low Power Oscillator interface

During standby mode, ANNA-B112 needs a 32.768 kHz clock source (accuracy ± 250 ppm or better). Several clock options are available, as shown in [Table 3](#).

Source	Current consumption	Comment
External 32.768kHz crystal	300 nA	Connected to the XL1 and XL2 pins. See also Pin definition .
Internal RC oscillator	620 nA + calibration	Needs recalibration every 8 s
External 32.768 kHz clock signal	–	Connected to the XL1 pin. See also Pin definition .

Table 3: Supported low power clock sources for ANNA-B112

For more information about the different 32.768 kHz clock source alternatives, see also the ANNA-B112 system integration manual [1].

2.4 System functions

ANNA-B112 modules are power efficient devices capable of operating in different power saving modes and configurations. Different sections of the module can be powered off when they are not needed, and complex wake-up events can be generated from different external and internal inputs. The radio part of the module operates independently from the CPU.

The two main power saving modes are:

- Standby mode
- Sleep mode

Depending on the application, the module should spend most of its time in sleep mode to conserve battery life.

2.4.1 Module power-on

ANNA-B112 can be switched on in one of the following ways, which causes the module to reboot:

- Rising edge on the VCC pin to a valid supply voltage
- Issuing a reset of the module

A wake-up event from sleep mode to active mode can be issued by:

- Changing the state of any digital I/O pin, which may be enabled /disabled for each pin.

If waking up from standby mode, an event can also be issued by:

- The on-board Real Time Counter (RTC)
- A programmable digital or analog sensor event. For example, rising voltage level on an analog comparator pin

2.4.2 Module power-off

There is no dedicated pin to power off ANNA-B112 modules. You can configure any GPIO pin to enter or exit the [Sleep mode](#), which essentially powers down the module.

An under-voltage (brown-out) shutdown occurs on ANNA-B112 modules when the **VCC** supply drops below the operating range minimum limit. If this occurs, it is not possible to store the current parameter settings in the non-volatile memory of the module. For more information, see also the ANNA-B112 system integration manual [1].

2.4.3 Standby mode

Standby mode is one of the power saving modes that essentially powers down ANNA-B112 but keeps the system RAM intact. It allows for a few low-power digital interfaces (including SPI) and analog functions to run continuously. It also allows for complex, autonomous, power-up events, including periodic RTC events and radio events.

The following events can be used to bring the module out of the standby mode:

- External wake-up events
- Internal wake-up events from RTC, radio, NFC and so on
- Analog or digital sensor event (programmable voltage level or edge detection)

 During standby mode, the module needs a 32.768 kHz clock source. For more information about the different alternatives for the 32.768 kHz clock source, see also [Low Power Oscillator interface](#).

2.4.4 Sleep mode

Sleep mode is the deepest power saving mode of ANNA-B112 modules. During sleep mode, all functionality is stopped to ensure minimum power consumption. The module needs an external event to wake up from sleep mode.

The following events can be used to wake up the module out of the sleep mode:

- External event on a digital pin
- External event on a low power comparator pin
- Detection of NFC field

When using the u-connectXpress software, the module can be manually switched on or off with proper storage of current settings using the UART **DSR** pin.

ANNA-B112 can be programmed to latch the digital values present at its GPIO pins during sleep. The module keeps the values latched, and a change of state on any of these pins triggers a wake up to active mode.

The module always reboots after wake up from the sleep mode; however, different sections of the RAM can be configured to remain intact during and after the entry into sleep mode.

2.4.5 Module reset

ANNA-B112 modules are reset in one of the following ways:

- Applying a low logic level on the **RESET_N** input pin, which is normally pulled high using an internal pull-up resistor. This causes an “external” or “hardware” reset of the module. The prevailing parameter settings are not saved in the non-volatile module memory and a proper network detach is not performed.
- Using the `AT+CPWROFF` command to initiate an “internal” or “software” reset of the module. The current parameter settings are saved in the non-volatile module memory and a proper network detach is performed.

2.4.6 Real Time Counter (RTC)

A key system feature available on the module is the Real Time Counter. This counter can generate multiple interrupts and events to the CPU and radio as well as internal and external hardware blocks. These events can be precisely timed ranging from microseconds up to hours and allow for periodic advertising of Bluetooth LE events without involving the main CPU. The RTC can be operated in power-on and standby modes.

 During standby mode, the module needs a 32.768 kHz clock source. See also [Low Power Oscillator interface](#).

2.5 Serial interfaces

ANNA-B112 modules support the following serial communication interfaces:

- 1x UART interface: 4-wire unbalanced asynchronous serial interface used for AT commands interface, data communication and u-connectXpress software upgrades using FOTA.
- 3x SPI interfaces: Up to three serial peripheral interfaces can be used simultaneously.
- 2x I2C interfaces: Inter-Integrated Circuit (I2C) interface for communication with digital sensors.

 Radio performance parameters, such as sensitivity, can be affected by high-frequency, digital I/O signals with a large sink/source current. Consequently, all pins described as “standard-drive, low-frequency GPIO only” in [Table 7](#) should not be used for high-frequency signals.

 All digital interface pins on the module are shared between the digital and analog interfaces and GPIOs. Any function can be assigned to any pin that is not already occupied.

2.5.1 Asynchronous serial interface (UART)

The UART interface supports hardware flow control and baud-rates up to 1 Mbps. Other characteristics of the UART interface are listed below:

- Data lines (RXD as input, TXD as output) and hardware flow control lines (CTS as input, RTS as output) are provided.
- Hardware flow control (default) or no flow control is supported.
- Power saving indication available on the hardware flow control output (CTS line): The line is driven to the OFF state when the module is not ready to accept data signals.
- Programmable baud-rate generator allows most industry standard rates, as well as non-standard rates up to 1 Mbps.
- Frame format configuration:
 - 8 data bits
 - Even or no-parity bit
 - 1 stop bit
- Default frame configuration is 8N1, meaning eight (8) data bits, no (N) parity bit, and one (1) stop bit.

 Radio performance parameters, such as sensitivity, can be affected by high-frequency, digital I/O signals with a large sink/source current. Consequently, all pins described as “standard-drive, low-frequency GPIO only” in [Table 7](#) should not be used for high-frequency signals. Do not allocate these pins to the UART interface.

2.5.2 Serial peripheral interface (SPI)

ANNA-B112 supports up to three Serial Peripheral Interfaces that can operate in both master and slave mode with a maximum serial clock frequency of 8 MHz in both modes. The SPI interfaces use four signals: **SCLK**, **MOSI**, **MISO**, and **CS**. When using the SPI interface in master mode, it is possible to use GPIOs as additional Chip Select (**CS**) signals to allow addressing of multiple slaves.

 Radio performance parameters, such as sensitivity, can be affected by high-frequency, digital I/O signals with a large sink/source current. Consequently, all pins described as “standard-drive, low-frequency GPIO only” in [Table 7](#) should not be used for high-frequency signals. Do not allocate these pins to the SPI interface.

2.5.3 I2C interface

The Inter-Integrated Circuit interfaces can be used to transfer or receive data on a 2-wire bus network. ANNA-B112 modules can operate as both master and slave on the I2C bus using both standard (100 kbps) and fast (400 kbps) transmission speeds. The interface uses the **SCL** signal-to-clock instructions and data on the **SDA** signal.

 Radio performance parameters, such as sensitivity, can be affected by high-frequency, digital I/O signals with a large sink/source current. Consequently, all pins described as “standard-drive, low-frequency GPIO only” in [Table 7](#) should not be used for high-frequency signals. Do not allocate these pins to the I2C interface.

2.5.4 I2S interface

The Inter-IC Sound (I2S) interface can be used to transfer audio sample streams between ANNA-B112 and external audio devices such as codecs, DACs, and ADCs. It supports original I2S and left or right-aligned interface formats in both master and slave mode.

It uses up to five signals:

- Master clock (**MCK**)
- Left right clock or Word clock (**LRCK**)
- Serial clock (**SCK**)
- Serial data in (**SDIN**)
- Serial data out (**SDOUT**)

The Master side of the interface always provides the **LRCK** and **SCK** clock signals, but as an addition ANNA-B112 can supply a **MCK** clock signal in both master and slave mode to provide to external systems that cannot generate their own clock signal. The two data signals - **SDIN** and **SDOUT** allow for simultaneous bi-directional audio streaming. The interface supports 8, 16 and 24-bit sample widths with up to 48 kHz sample rate.

 Radio performance parameters, such as sensitivity, can be affected by high-frequency, digital I/O signals with a large sink/source current. Consequently, all pins described as “standard-drive, low-frequency GPIO only” in [Table 7](#) should not be used for high-frequency signals. Do not allocate these pins to the I2C interface.

2.6 GPIO

ANNA-B112 modules have a versatile pin-out. If left un-configured, there are 25 GPIO pins in total – with no analog or digital interfaces. All digital interfaces or functions must then be allocated to a GPIO pin before use. Eight out of the 25 GPIO pins are analog enabled and can consequently have an analog function allocated to them. [Table 4](#) shows the number of digital and analog functions that can be assigned to a GPIO pin in addition to the serial interfaces.

Function	Description	Default ANNA pin	Configurable GPIOs
General purpose input	Digital input with configurable edge detection and interrupt generation		Any
General purpose output	Digital output with configurable drive strength, pull-up, pull-down, open-source, open-drain and/or slew rate		Any
Pin disabled	Pin is disconnected from input buffers and output drivers. All*		Any
Timer/ counter	High precision time measurement between two pulses/ Pulse counting with interrupt/event generation		Any
Interrupt/ Event trigger	Interrupt/event trigger to the software application/ Wake up event		Any
ADC input	8/10/12-bit analog to digital converter		Any analog
Analog comparator input	Compare two voltages, capable of generating wake-up events and interrupts		Any analog
PWM output	Output complex pulse width modulation waveforms		Any
Connection status indication	Indicates if a BLE connection is maintained	BLUE**	Any

* = If left unconfigured

** = If using the u-connectXpress software

Table 4: GPIO custom functions configuration

 The pins dedicated to the NFC antenna function (**NFC1** and **NFC2**) have some limitation when the pins are configured for normal GPIO operation. The pin capacitance is higher on those, and you can expect some increased leakage current between the two pins if they are used in GPIO mode and are driven to different logical values. To save power, the two pins should always be set to the same logical value whenever entering one of the device power saving modes. See also [Digital pins](#).

2.6.1 PWM

ANNA-B112 modules provide up to 12 independent PWM channels that can be used to generate complex waveforms. These waveforms can be used to control motors, dim LEDs and as audio signals, if connected to speakers. Duty-cycle sequences may be stored in RAM to be chained and looped into complex sequences without CPU intervention. Each channel uses a single GPIO pin as output.

2.7 Analog interfaces

8 of the 25 digital GPIOs can be multiplexed to analog functions. The following analog functions are available for use:

- 1x 8-channel ADC
- 1x Analog comparator*
- 1x Low-power analog comparator*

*Only one of the comparators can be used simultaneously.

2.7.1 ADC

The Analog to Digital Converter (ADC) can sample up to 200 kHz using different inputs as sample triggers. It supports 8/10/12-bit resolution. Any of the 8 analog inputs can be used both as single-ended inputs and as differential pairs for measuring the voltage across them. The ADC supports full 0 V to VCC input range.

2.7.2 Comparator

The comparator compares voltages from any analog pin with different references as shown in [Table 5](#). It supports full 0 V to VCC input range and can generate different software events to the rest of the system.

2.7.3 Low power comparator

The low-power comparator operates in the same way as the normal comparator, with some reduced functionality. It can be used during sleep mode as a wake-up source.

2.7.4 Analog pin options

[Table 5](#) shows the supported connections of the analog functions.

 An analog pin may not be simultaneously connected to multiple functions.

Analog function	Can be connected to
ADC single-ended input	Any analog pin or VCC
ADC differential input	Any analog pin or VCC pair
Comparator IN+	Any analog pin
Comparator IN-	Pin 19 or 20, VCC, 1.2 V, 1.8 V, 2.4 V
Low-power comparator IN+	Any analog pin
Low-power comparator IN-	Pin 19 or 20, 1/16 to 15/16 VCC in steps of 1/16 VCC

Table 5: Possible uses of analog pin

2.8 u-connectXpress software features

This section describes the available features when using ANNA-B112 with u-connectXpress software. See also the u-connect AT commands manual [2].

2.8.1 u-blox Serial Port Service (SPS)

The serial port service feature enables serial port emulation over Bluetooth low energy.

2.8.2 System status signals

The **RED**, **GREEN** and **BLUE** pins are used to signal the system status according to Table 6. The pins are active low and are intended to be routed to an RGB LED.

Mode	Status	RGB LED color	RED	GREEN	BLUE
Data\Extended Data mode (EDM)	IDLE	Green	HIGH	LOW	HIGH
Command mode	IDLE	Orange	LOW	LOW	HIGH
EDM/Data mode, Command mode	CONNECTING	Purple	LOW	HIGH	LOW
EDM/Data mode, Command mode	CONNECTED*	Blue	HIGH	HIGH	LOW

* = LED flashes on data activity

Table 6: System status indication

 CONNECTING and CONNECTED statuses indicate u-blox SPS connections.

2.8.3 System control signals

The following input signals are used to control the system:

- **RESET_N** is used to reset the system. See also [Module reset](#).
- If **SWITCH_2** is driven low during start up, the UART serial settings are restored to their default values.
- **SWITCH_2** can be used to open a Bluetooth LE connection with a peripheral device.
- If both **SWITCH_1** and **SWITCH_2** are driven low during start up, the system will enter the bootloader mode.
- If both **SWITCH_1** and **SWITCH_2** are driven low during start up and held low for 10 seconds, the system will exit the bootloader mode and restore all settings to their factory default.

2.8.4 UART signals

In addition to the normal **RXD**, **TXD**, **CTS**, and **RTS** signals, the u-connectXpress software adds the **DSR** and **DTR** pins to the UART interface. Note that they are not used as originally intended, but to control the state of the ANNA module. For example, depending on the current configuration:

The **DSR** pin can be used to:

- Enter command mode
- Disconnect and/or toggle connectable status
- Enable/disable the rest of the UART interface
- Enter/wake up from sleep mode

The **DTR** pin can be used to indicate:

- The system mode
- If the SPS peers are connected
- If a Bluetooth LE bonded device is connected
- A Bluetooth LE GAP connection

 See also the u-connect AT commands manual [2].

2.8.5 IO signals

When using the u-connectXpress software, 11 module pins can be used for manual, digital read/write operations. These pins can be configured as outputs or inputs, with or without pull-up/pull-down, using AT commands. For more information, see also the u-connect AT commands manual [2].

 In this data sheet, these signals are defined as IO signals to distinguish from the GPIO signals described in [GPIO](#). The IO signals are used with u-connectXpress software only and controlled using AT commands. The GPIO signals, representing hardware functionality, can only be used by writing a custom software application.

2.9 Debug interfaces

2.9.1 SWD

ANNA-B112 series modules provide an SWD interface for flashing and debugging. The SWD interface consists of two pins: **SWDCLK** and **SWDIO**.

2.9.2 Trace – Serial Wire Viewer

A serial trace option is also available as an additional pin: **SWO**. The Serial Wire Output is used to:

- Support printf style debugging
- Trace OS and application events
- Emit diagnostic system information

A debugger that supports Serial Wire Viewer (SWV) is required. The trace function can be used only when developing a custom application.

3 Pin definition

3.1 Open CPU pin assignment

Figure 3 shows the pin-out of the module in an unconfigured state. Alternatively, you can use the [pin assignment for u-connectXpress software](#).

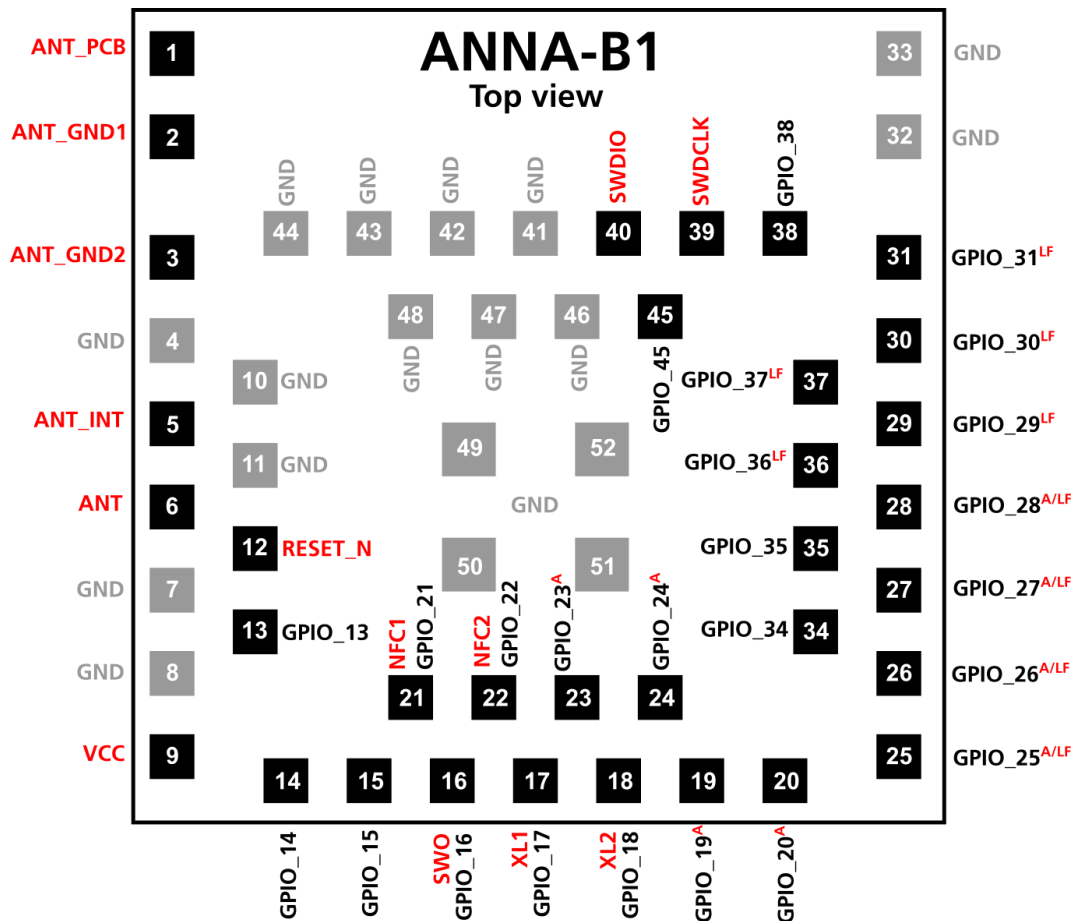

A = Analog function capable pin LF = Low Frequency, low drive I/O only
 Signals that are highlighted in red are locked to a specific pin, the grey pins are GND pins.

Figure 3: ANNA-B112 pin assignment open CPU (top view)

All digital or analog functions described in this data sheet may be freely assigned to any GPIO pin. Analog functions are limited to analog capable pins.

GPIO pins 25–31 and 36–37 are connected to pins located close to the radio part of the RF chip. It is advisable to avoid using these pins for high-speed digital interfaces or sinking/sourcing large currents through them. Doing so can adversely affect RF performance.

Do not apply an NFC field to the NFC pins when they are configured as GPIOs as it can cause permanent damage to the module. When driving different logic levels on these pins in GPIO mode, a small current leakage occurs. Ensure that they are set to the same logic level before entering any power saving modes. See also [Digital pins](#).

No.	Name	I/O	Description	nRF52 port	Remarks
1	ANT_PCB	–	Antenna pattern on carrier board if the module is mounted in a corner.		Should only be connected if the module is mounted in a corner. See also 2.4 GHz Bluetooth Low Energy (ANT) .
2	ANT_GND1	–	Antenna ground pattern if the module is mounted in the middle of a side.		Should only be connected if the module is mounted in the middle of a side. See also 2.4 GHz Bluetooth Low Energy (ANT) .
3	ANT_GND2	–	Antenna grounding if the module is mounted in the middle of a side.		Should only be connected if the module is mounted in the middle of a side. See also 2.4 GHz Bluetooth Low Energy (ANT) .
4	GND	–	Ground		
5	ANT_INT	–	Feeding to internal antenna of the module.		Connect to ANT pin if the internal antenna is used. See also 2.4 GHz Bluetooth Low Energy (ANT) .
6	ANT	–	Tx/Rx antenna interface.		50 Ω nominal characteristic impedance. Connect to ANT pin if the internal antenna is used. See also 2.4 GHz Bluetooth Low Energy (ANT) .
7–8	GND	–	Ground		
9	VCC	–	Module supply voltage input		1.7–3.6 V range
10–11	GND	–	Ground		
12	RESET_N	I/O	System reset input	P0.21	Active low
13	GPIO_13	I/O	General purpose I/O	P0.14	
14	GPIO_14	I/O	General purpose I/O	P0.15	
15	GPIO_15	I/O	General purpose I/O	P0.16	
16	SWO/GPIO_16	I/O	Serial Wire debug trace data output	P0.18	May be used as a GPIO
17	XL1	I/O	Connection for 32.768 kHz crystal (LFXO)	P0.00	If internal RC-oscillator is used, ground XL1 and XL2.
18	XL2	I/O	Connection for 32.768 kHz crystal (LFXO)	P0.01	If an external clock source is used instead of a crystal: <ul style="list-style-type: none"> • Apply external low swing signal to XL1, ground XL2. • Apply external full swing signal to XL1, leave XL2 grounded or unconnected. • May be used as a GPIO.
19	GPIO_19	I/O	Analog function enabled GPIO	P0.03	Pin is analog capable
20	GPIO_20	I/O	Analog function enabled GPIO	P0.02	Pin is analog capable
21	NFC1/GPIO_21	I/O	NFC pin 1 (default)	P0.09	May be used as a GPIO
22	NFC2/GPIO_22	I/O	NFC pin 2 (default)	P0.10	May be used as a GPIO
23	GPIO_23	I/O	Analog function enabled GPIO	P0.05	Pin is analog capable
24	GPIO_24	I/O	Analog function enabled GPIO	P0.04	Pin is analog capable
25	GPIO_25	I/O	Analog function enabled GPIO	P0.31	Pin is analog capable. Use as standard drive, low frequency GPIO only.
26	GPIO_26	I/O	Analog function enabled GPIO	P0.30	Pin is analog capable. Use as standard drive, low frequency GPIO only.

No.	Name	I/O	Description	nRF52 port	Remarks
27	GPIO_27	I/O	Analog function enabled GPIO	P0.29	Pin is analog capable. Use as standard drive, low frequency GPIO only.
28	GPIO_28	I/O	Analog function enabled GPIO	P0.28	Pin is analog capable. Use as standard drive, low frequency GPIO only.
29	GPIO_29	I/O	General purpose I/O	P0.27	Use as standard drive, low frequency GPIO only.
30	GPIO_30	I/O	General purpose I/O	P0.25	Use as standard drive, low frequency GPIO only.
31	GPIO_31	I/O	General purpose I/O	P0.26	Use as standard drive, low frequency GPIO only.
32-33	GND	-	Ground		
34	GPIO_34	I/O	General purpose I/O	P0.11	
35	GPIO_35	I/O	General purpose I/O	P0.19	
36	GPIO_36	I/O	General purpose I/O	P0.22	Use as standard drive, low frequency GPIO only.
37	GPIO_37	I/O	General purpose I/O	P0.23	Use as standard drive, low frequency GPIO only.
38	GPIO_38	I/O	General purpose I/O	P0.24	
39	SWDCLK	I	Serial Wire Debug port clock signal		
40	SWDIO	I/O	Serial Wire Debug port data signal		
41-44	GND	-	Ground		
45	GPIO_45	I/O	General purpose I/O	P0.20	
46-48	GND	-	Ground		
49-52	EGP	-	Exposed Ground Pins		The exposed pins in the center of the module should be connected to GND.

Table 7: ANNA-B112 pin-out open CPU

3.2 u-connectXpress pin assignment

Figure 4 shows the pin-out and pin configuration for use with u-connectXpress software. The grey pins are GND pins. The function of each pin is described in Table 8.

The pin assignments are only applicable for the latest u-connectXpress software version.

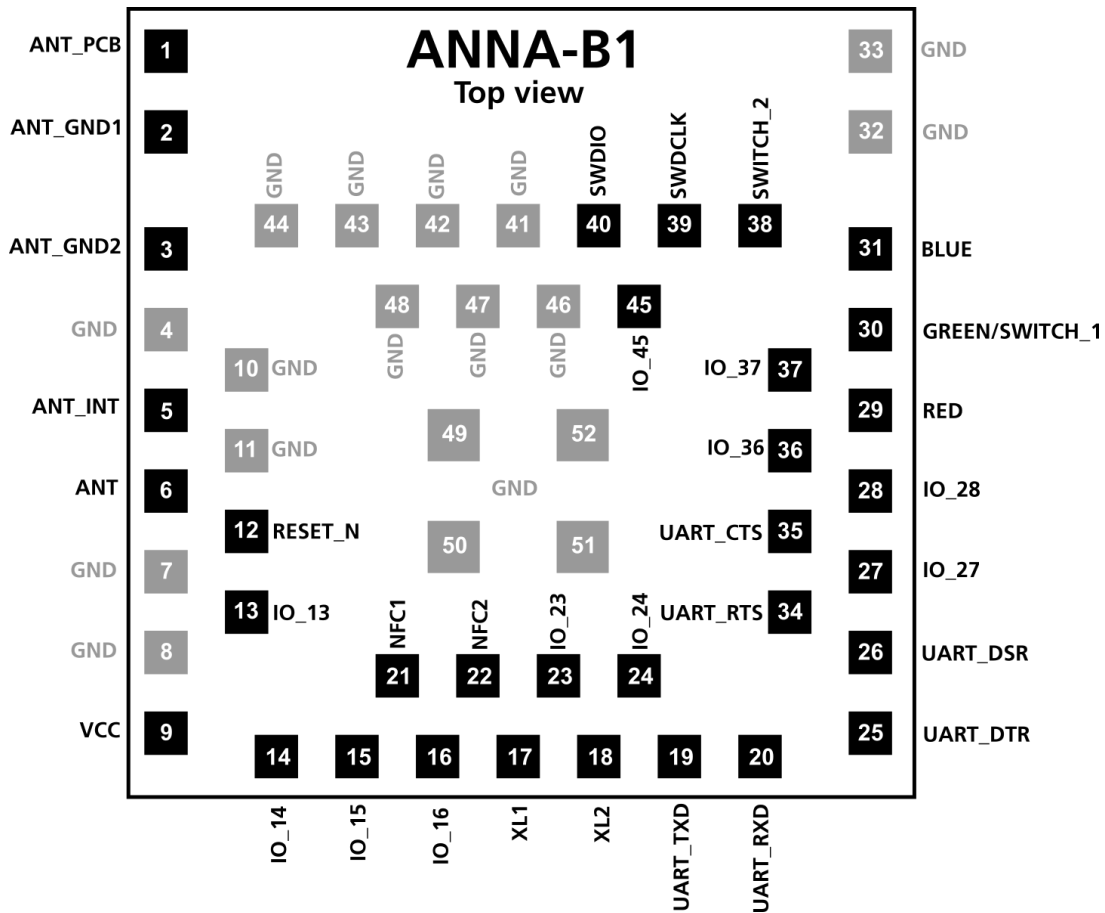

Figure 4: ANNA-B112 pin assignment (top view) applicable for u-connectXpress software

This pin layout must be followed when using u-connectXpress software. No additional interfaces can be added.

No.	Name	I/O	Description	Remarks
1	ANT_PCB	-	Antenna pattern on carrier board if the module is mounted in a corner.	Should only be connected if the module is mounted in a corner. See also 2.4 GHz Bluetooth Low Energy (ANT) .
2	ANT_GND1	-	Antenna ground pattern if the module is mounted in the middle of a side.	Should only be connected if the module is mounted in the middle of a side. See also 2.4 GHz Bluetooth Low Energy (ANT) .
3	ANT_GND2	-	Antenna grounding if the module is mounted in the middle of a side.	Should only be connected if the module is mounted in the middle of a side. See also 2.4 GHz Bluetooth Low Energy (ANT) .
4	GND	-	Ground	
5	ANT_INT	-	Feeding to internal antenna of the module.	Connect to ANT pin if the internal antenna is used. See also 2.4 GHz Bluetooth Low Energy (ANT) .
6	ANT	-	Tx/Rx antenna interface.	50 Ω nominal characteristic impedance. Connect to ANT pin if the internal antenna is used. See also 2.4 GHz Bluetooth Low Energy (ANT) .
7-8	GND	-	Ground	
9	VCC	-	Module supply voltage input	1.7-3.6 V range.
10-11	GND	-	Ground	
12	RESET_N	I	System reset input	Active low
13	IO_13	I/O	u-connectXpress software IO pin	Can be used for manual digital I/O
14	IO_14	I/O	u-connectXpress software IO pin	Can be used for manual digital I/O
15	IO_15	I/O	u-connectXpress software IO pin	Can be used for manual digital I/O
16	IO_16	I/O	u-connectXpress software IO pin	Can be used for manual digital I/O
17	XL1	-	Connection for 32.768 kHz crystal (LFXO)	If internal RC-oscillator is used, ground XL1 and XL2.
18	XL2	-	Connection for 32.768 kHz crystal (LFXO)	If an external clock source is used instead of a crystal: Apply external low swing signal to XL1, ground XL2. Apply external full swing signal to XL1, leave XL2 grounded or unconnected.
19	UART_TXD	O	UART data output	
20	UART_RXD	I	UART data input	
21	NFC1	I/O	NFC pin 1	
22	NFC2	I/O	NFC pin 2	
23	IO_23	I/O	u-connectXpress software IO pin	Can be used for manual digital I/O
24	IO_24	I/O	u-connectXpress software IO pin	Can be used for manual digital I/O
25	UART_DTR	O	UART data terminal ready signal	Used to indicate system status
26	UART_DSR	I	UART data set ready signal	Used to change system modes
27	IO_27	I/O	u-connectXpress software IO pin	Can be used for manual digital I/O
28	IO_28	I/O	u-connectXpress software IO pin	Can be used for manual digital I/O
29	RED	O	RED system status signal	Active low, should be routed to an RGB LED
30	GREEN/SWITCH_1	I/O	This signal is multiplexed: GREEN: System status signal. SWITCH_1: Multiple functions	Active low. GREEN: Should be routed to an RGB LED. SWITCH_1: See also System control signals .
31	BLUE	O	BLUE system status signal	Active low, should be routed to an RGB LED
32-33	GND	-	Ground	

No.	Name	I/O	Description	Remarks
34	UART_RTS	O	UART request to send control signal	Used only when hardware flow control is enabled
35	UART_CTS	I	UART clear to send control signal	Used only when hardware flow control is enabled
36	IO_36	I/O	u-connectXpress software IO pin	Can be used for manual digital I/O
37	IO_37	I/O	u-connectXpress software IO pin	Can be used for manual digital I/O
38	SWITCH_2	I	Multiple functions	Active low. See also System control signals .
39	SWDCLK	I	Serial Wire Debug port clock signal	
40	SWDIO	I/O	Serial Wire Debug port data signal	
41-44	GND	-	Ground	
45	IO_45	I/O	u-connectXpress software IO pin	Can be used for manual digital I/O
46-48	GND	-	Ground	
49-52	EGP	-	Exposed Ground Pins	The exposed pins in the center of the module should be connected to GND

Table 8: ANNA-B112 and u-connectXpress software pin-out

4 Electrical specifications

Stressing the device above one or more of the ratings listed in the [Absolute maximum ratings](#) can cause permanent damage. These are stress ratings only. Operating the module at these or at any conditions other than those specified in the [Operating conditions](#) should be avoided. Exposure to absolute maximum rating conditions for extended periods can affect device reliability.

All given application information is only advisory and does not form part of the specification.

4.1 Absolute maximum ratings

Symbol	Description	Condition	Min	Max	Unit
VCC	Module supply voltage	Input DC voltage at VCC pin	-0.3	3.9	V
P_ANT	Maximum power at receiver	Input RF power at antenna pin		+10	dBm

Table 9: Absolute maximum ratings

The product is not protected against overvoltage or reversed voltages. If necessary, voltage spikes exceeding the power supply voltage specification, given in table above, must be limited to values within the specified boundaries by using appropriate protection devices.

4.1.1 Maximum ESD ratings

Parameter	Min	Typical	Max	Unit	Remarks
ESD sensitivity for all pins except ANT pin			2	kV	Human body model according to JEDEC JS001
			500	V	Charged device model according to JESD22-C101
ESD indirect contact discharge			±8*	kV	According to EN 301 489-1

*Tested on EVK-ANNA-B1

Table 10: Maximum ESD ratings

ANNA-B112 modules are Electrostatic Sensitive Devices and require special precautions while handling. See also [ESD precautions](#).

4.2 Operating conditions

Unless otherwise specified, all operating condition specifications are at an ambient temperature of 25°C and a supply voltage of 3.3 V.

Operation beyond the specified operating conditions is not recommended and extended exposure beyond them may affect device reliability.

4.2.1 Operating temperature range

Parameter	Min	Max	Unit
Storage temperature	-40	+85	°C
Operating temperature	-40	+85	°C

Table 11: Temperature range

4.2.2 Supply/Power pins

Symbol	Parameter	Min	Typ	Max	Unit
VCC	Input supply voltage	1.7	3.0	3.6	V
t_RVCC	Supply voltage rise time			60	ms
VCC_ripple	VCC input noise peak to peak, 10–100 KHz			100	mV
	VCC input noise peak to peak, 100 KHz–1 MHz			50	mV
	VCC input noise peak to peak, 1–3 MHz			25	mV

Table 12: Input characteristics of voltage supply pins

4.2.3 Current consumption

Table 13 shows the typical current consumption of the ANNA-B112 module at 3.0 V and DCDC.

Condition	Typ	Max
No clocks running, no RAM data retention	300 nA	
No clocks running, 64 kB RAM data retention	620 nA	
RTC and 64 kB RAM data retention. System running on 32.768 kHz clock from crystal.	2.2 μ A	
CPU running benchmarking tests @ 64 MHz clock speed, all interfaces idle	3.7 mA	
Radio RX only	5.4 mA	
Radio TX only, +0dBm output power	5.3 mA	

Table 13: Module VCC current consumption

Table 14 shows the current consumption during some typical use cases when using the u-connectXpress software 2.0.0 and an external 32.768 kHz crystal – unless specified otherwise:

Mode	Condition	3.3 V VCC		1.8 V VCC	
		Average	Peak	Average	Peak
Active	Advertising 1s periods with +4 dBm output power and 31 bytes payload, CPU and UART interface is running	1.3 mA	12 mA	1.9 mA	20 mA
Standby	Advertising 1s periods with +4 dBm output power and 31 bytes payload, <i>external 32.768 kHz crystal</i>	26 μ A	9.3 mA	34 μ A	16 mA
Standby	Advertising 1s periods with +4 dBm output power and 31 bytes payload, <i>internal RC-oscillator and 4s calibration period</i>	32 μ A	9.3 mA	40 μ A	16 mA
Standby	One advertisement event (4.7 ms), +4 dBm output power and 31 bytes payload	3.4 mA	9.3 mA	5.1 mA	16 mA
Active	Connected as peripheral, connection events 30 ms periods, +4 dBm output power and 0 bytes payload, CPU and UART interface is running	1.4 mA	12 mA	2.0 mA	20 mA
Standby	Connected as peripheral, connection events 30 ms periods, +4 dBm output power and 0 bytes payload	120 μ A	9.3 mA	150 μ A	16 mA
Sleep	UART DSR pin is used to enter sleep mode. No RAM retention	300 nA	2.3 mA	300 nA	2.3 mA

Table 14: Current consumption during typical use cases

4.2.4 RF performance

Parameter	Test condition	Min	Typ	Max	Unit
Receiver input sensitivity	Conducted at 25 °C		-91		dBm
Output power	Conducted at 25 °C		+4		dBm

Table 15: RF performance

4.2.5 Throughput characteristics

Table 16 shows some typical values for the throughput, using the u-blox SPS service, of the ANNA-B112 modules in room environment at short range. The test is performed between two ANNA-B112 modules running u-connectXpress 4.0.0.

 Several connected devices reduce the throughput.

Radio mode	Activity	Power mode	Role	Typical value (kbit/s)		Remarks
Bluetooth LE	Transmitting (Simplex)	ACTIVE	Central->Peripheral	780		PHY 2M, MTU 247, UART 1 Mbps, connection interval 7.5 ms
	Transmitting + Receiving (Duplex)	ACTIVE	Central<->Peripheral	555	555	PHY 2M, MTU 247, UART 1 Mbps, connection interval 7.5 ms

Table 16: Throughput characteristics

4.2.6 Latency

Latency is measured with two modules connected to the same host and is calculated as the time between when the string is written to UART on module 1 and when it is read in full on UART of module 2. The string is sent between the modules over SPS.

String length	UART speed	Connection interval	Latency (ms)		Remarks
			Median	Max	
1	1 Mbps	7.5 ms	6.7	10.7	MTU 247
20	1 Mbps	7.5 ms	7.4	11.4	MTU 247
244	1 Mbps	7.5 ms	16.3	20.5	MTU 247

Table 17: Approximate latency values

 Latency measurements are performed in an automatic test system with a low latency host, where the UART driver latency is set to 1 ms.

4.2.7 ANNA-B112 radiation patterns

The antenna radiation test set-up utilizes the reference design and is performed with ANNA-B112 situated in the corner of the evaluation board, EVK-ANNA-B112C. For more information, see also the ANNA-B112 system integration manual [1].

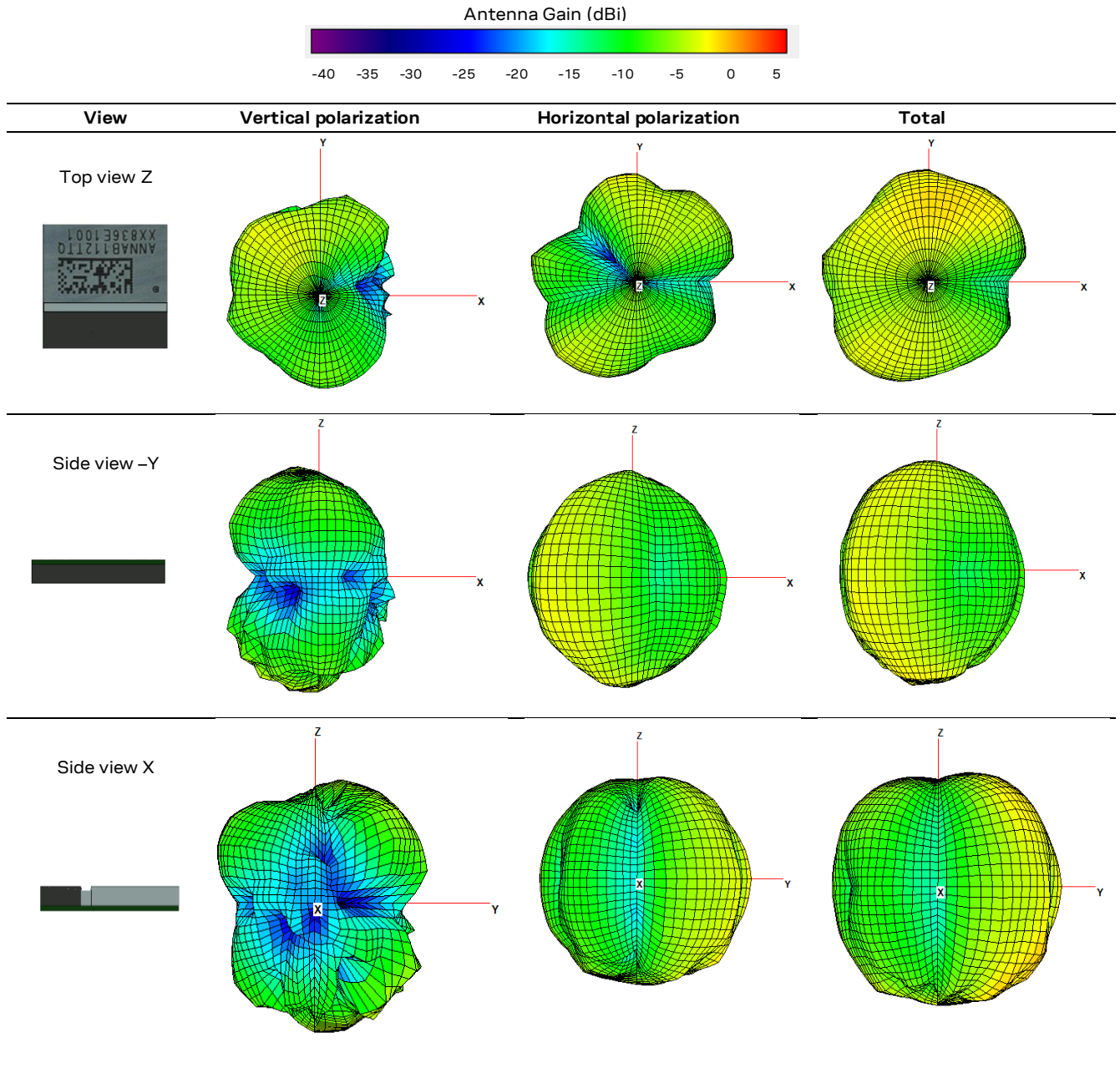

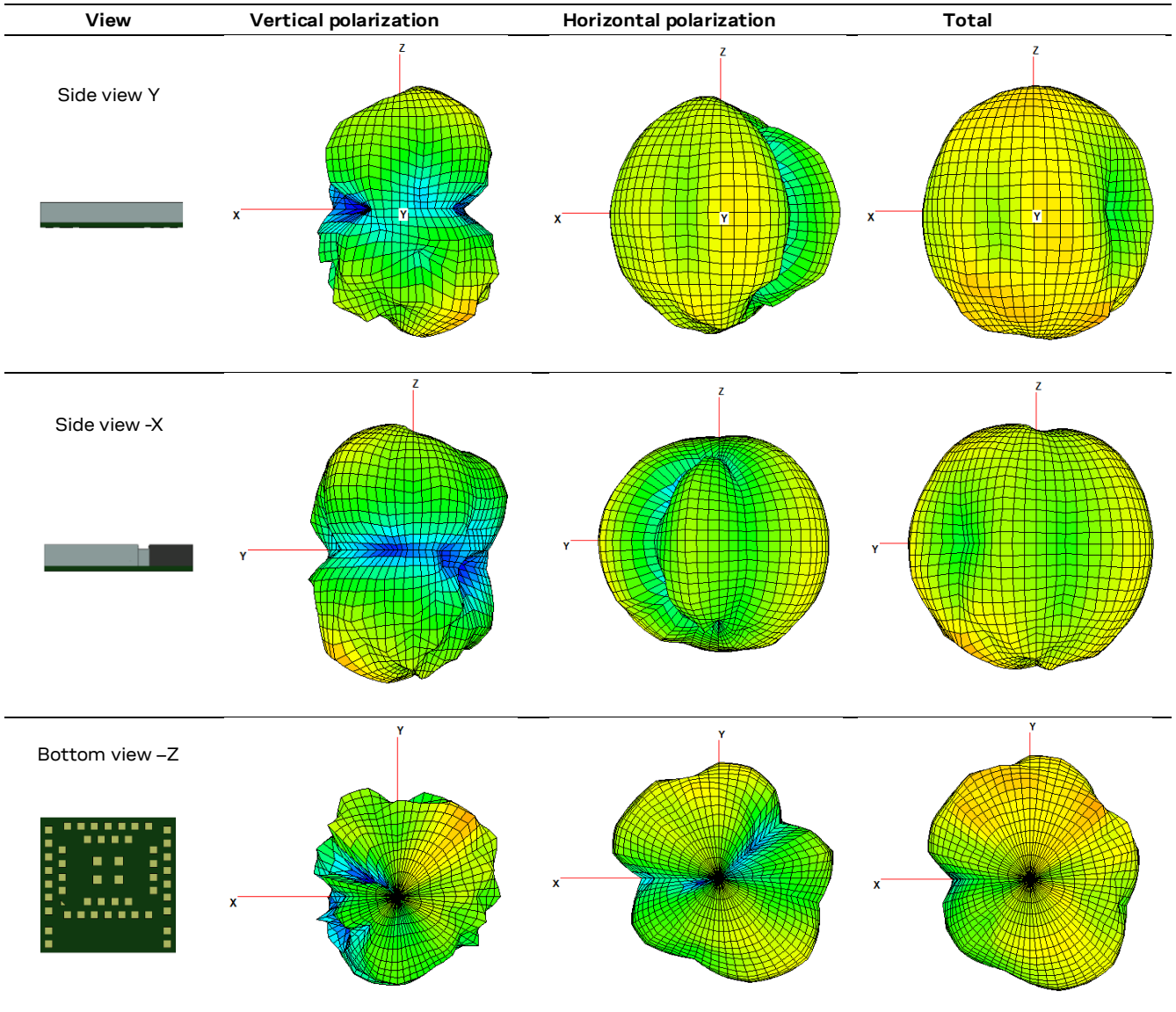

Table 18: Antenna radiation patterns

4.2.8 RESET_N pin

Pin name	Parameter	Min	Typ	Max	Unit	Remarks
RESET_N	Low-level input	0		0.3*VCC	V	
	Internal pull-up resistance		13		kΩ	
	RESET duration			55	ms	Time taken to release a pin reset.

Table 19: RESET_N pin characteristics

4.2.9 Digital pins

Pin name	Parameter	Min	Typ	Max	Unit	Remarks	
Any digital pin	Input characteristic: Low-level input	0		0.3*VCC	V		
	Input characteristic: high-level input		0.7*VCC	VCC	V		
	Output characteristic: Low-level output		0		0.4	V	Normal drive strength
			0		0.4	V	High drive strength
	Output characteristic: High-level output		VCC-0.4		VCC	V	Normal drive strength
			VCC-0.4		VCC	V	High drive strength
	Pull-up resistance	11	13	16	kΩ		
Pull-down resistance	11	13	16	kΩ			
Any digital pin except IO_28 and IO_29	Pin capacitance		3		pF		
IO_28 and IO_29	Leakage current		2	10	μA	When driven to different logic levels	
	Pin capacitance		4		pF		

Table 20: Digital pin characteristics

5 Qualifications and approvals

ANNA-B112 modules are certified for use in the following countries/regions:

- Europe (ETSI RED)
- Great Britain (UKCA)
- US (FCC/CFR 47 part 15 unlicensed modular transmitter approval)
- Canada (IC/ISED RSS)
- Japan (MIC)
- Taiwan (NCC)
- South Korea (KCC)
- Australia / New Zealand (ACMA / RCM mark)
- Brazil (ANATEL)
- South Africa (ICASA)
- China (SRRC)

For compliance information, see the ANNA-B112 system integration manual [\[1\]](#).

5.1 Bluetooth qualification

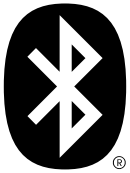

ANNA-B112 modules are qualified in accordance with Bluetooth version 5.0 specifications. For end products integrating ANNA-B112 modules used together with the pre-installed u-connectXpress software, and Open CPU configurations that use u-blox Bluetooth LE modules based on Nordic nRF5 chipsets, no further testing is required. If the End Product is to be Bluetooth listed, see the ANNA-B112 system integration manual [\[1\]](#) for further information.

6 Mechanical specifications

Figure 5 shows the mechanical outline of the ANNA-B112 package.

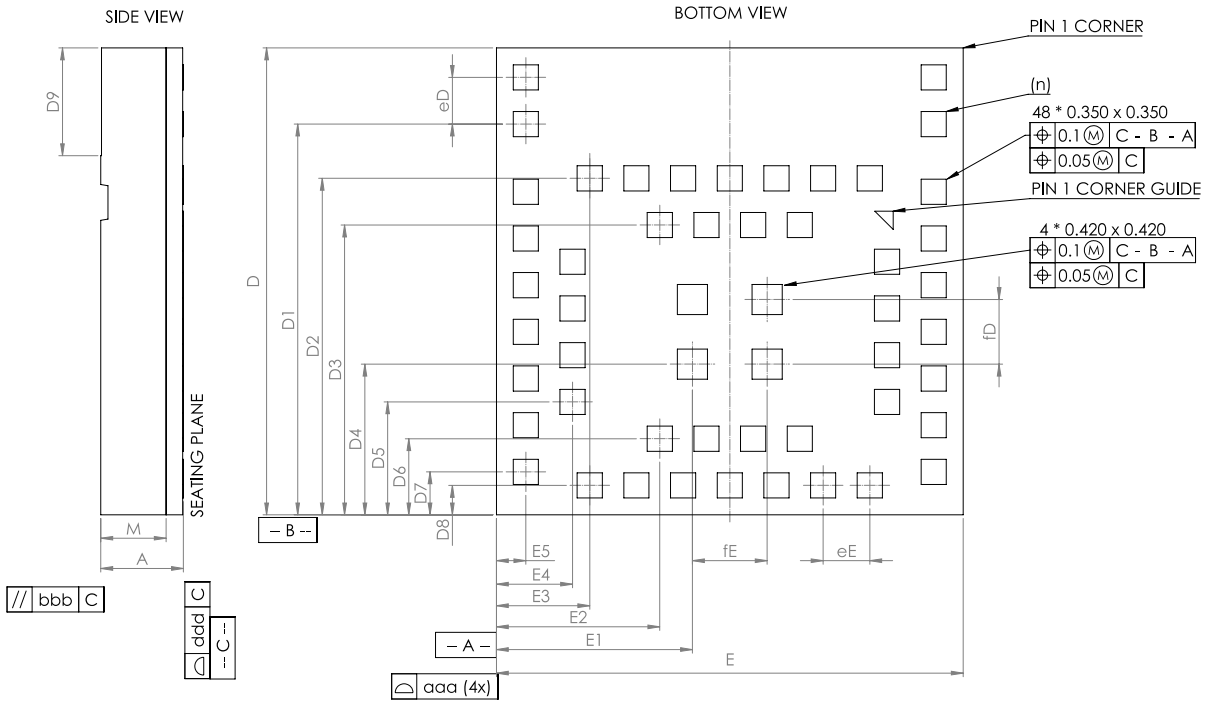

Description	Symbol	Dimensions (mm)	Tolerance (mm)
Package		PIM	
Width	E	6.500	+/- 0.100
Length	D	6.500	+/- 0.100
Outer Pitch	eE	0.650	
Outer Pitch	eD	0.650	
Inner Pitch	fE	1.040	
Inner Pitch	fD	0.900	
Total thickness	A	1.150	+/- 0.100
Mold thickness	M	0.210	
	E1	2.730	
	E2	2.275	
	E3	1.300	
	E4	1.060	
	E5	0.410	
	D1	5.440	
	D2	4.685	
	D3	4.035	
	D4	2.033	
	D5	1.573	
	D6	1.060	
	D7	0.598	
	D8	0.410	
Antenna Area	D9	1.50	
Lead Count	n	52	
Package Edge Tolerance	aaa	0.100	
Mold Flatness	bbb	0.100	
Coplanarity	ddd	0.100	

Figure 5: ANNA-B112 mechanical specifications

7 Product handling

7.1 Packaging

ANNA-B112 modules are delivered as hermetically sealed, reeled tapes to enable efficient production, production lot setup and tear-down.

7.2 Reels

The reel types and part numbers for ANNA-B112 modules are described in [Table 21](#). See also the Product packaging guide [\[6\]](#).

Model	Reel type	Reel part number	Qty
ANNA-B112	F	MYR-131-BB	500 pcs/reel

Table 21: Reel type for ANNA-B112

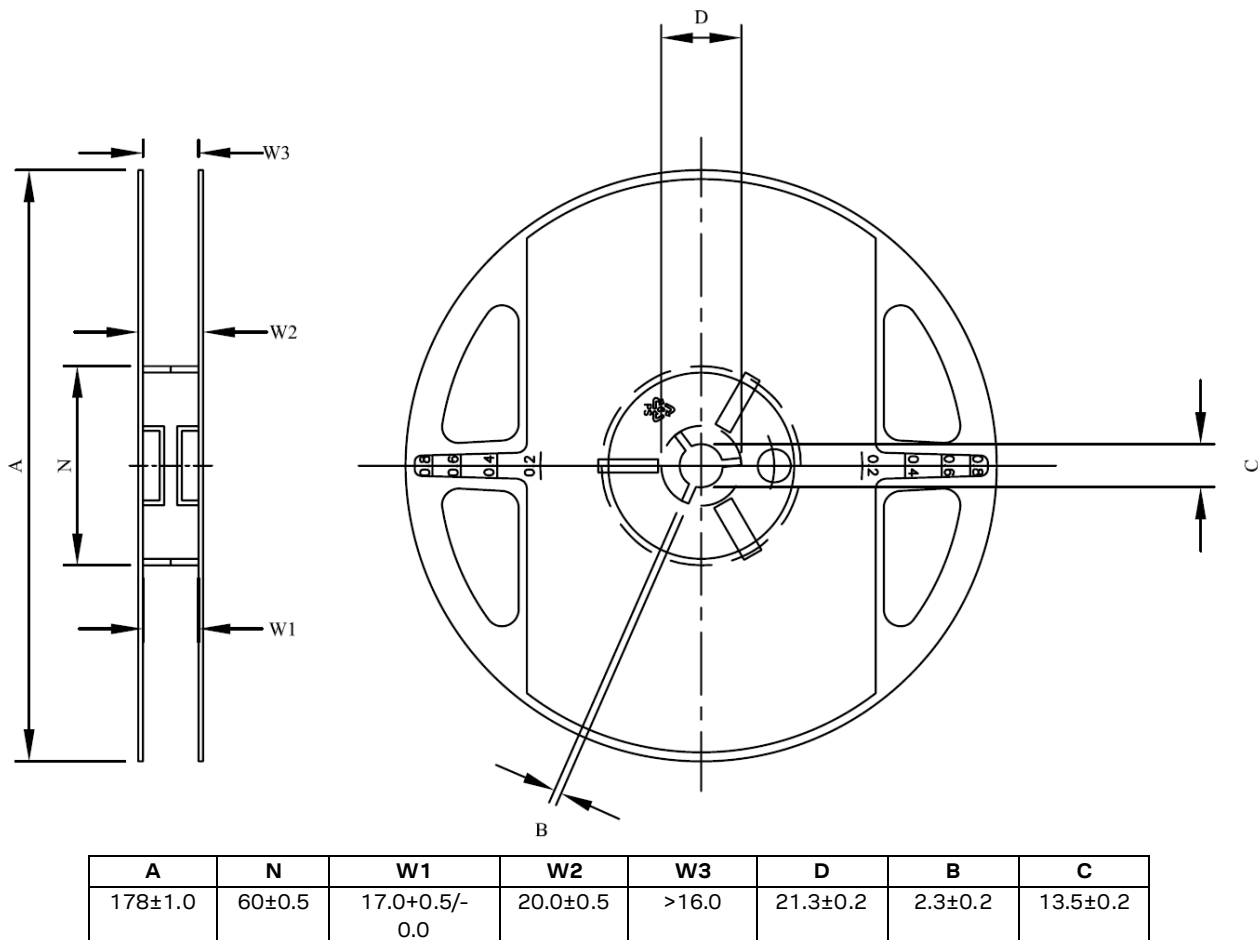

Figure 6: Seven-inch reel for ANNA-B112 modules

7.3 Tapes

Figure 7 shows the position and orientation of ANNA-B112 modules as they are delivered on tape. The dimensions of the tapes are specified in Figure 8.



Figure 7: Orientation of ANNA-B112 modules on tape

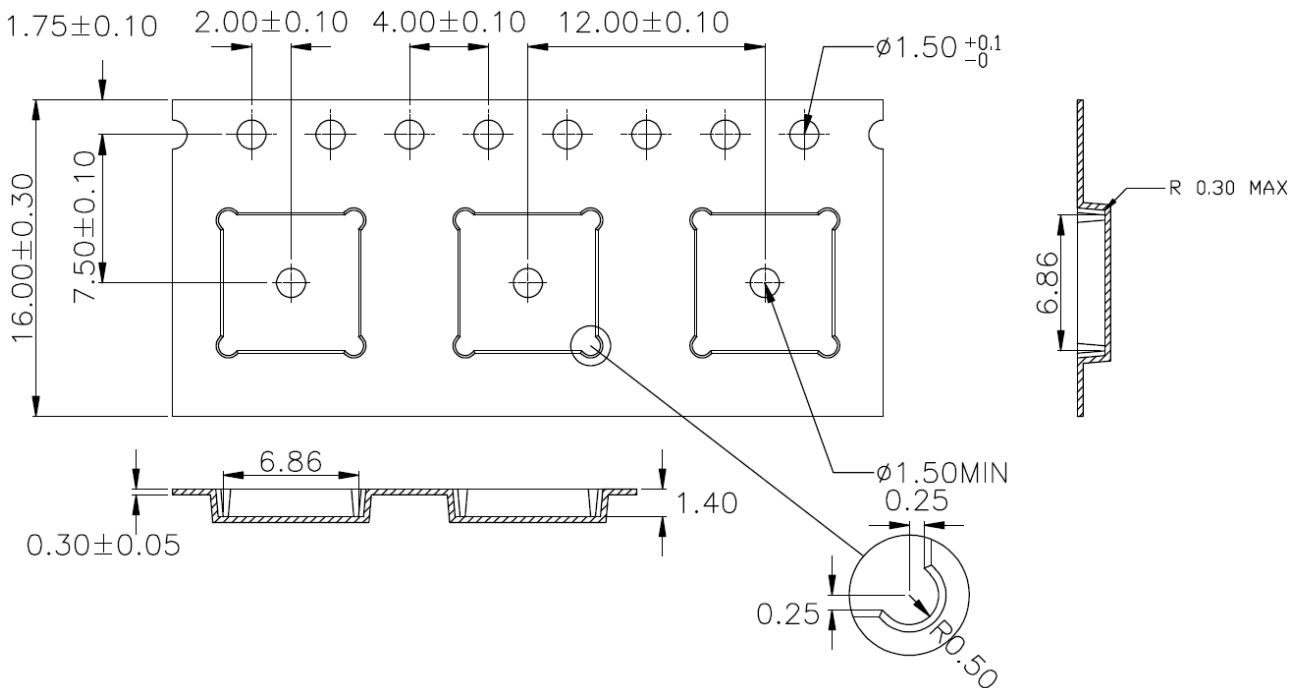

Sprocket hole pitch cumulative tolerance ± 0.20 .

Carrier camber is within 1mm in 250 mm.

Material: Black Conductive Polyester Allow (ABS+PS).

All dimensions meet EIA-481-D requirements.

Thickness: 0.30 ± 0.05 mm.

Surface resistivity: $105 \sim 109 \Omega/\text{sq}$.

Figure 8: ANNA-B112 tape dimensions

7.4 Moisture sensitivity levels

-  ANNA-B112 modules are rated as MSL Level 3 devices in accordance with the IPC/JEDEC J-STD-020 standard. For detailed information, see the moisture sensitive warning label on the MBB (Moisture Barrier Bag).

After opening the dry pack, the modules must be mounted within 168 hours in factory conditions of maximum 30 °C/60%RH or must be stored at less than 10%RH. The modules require baking if the humidity indicator card shows more than 10% when read at 23±5 °C or if the conditions mentioned above are not met. For information about the bake procedure, see also the J-STD-033B standard.

-  For more information regarding MSL (Moisture Sensitivity Level), labeling, and storage, see also the Packaging information guide [\[6\]](#).

7.5 Reflow soldering

ANNA-B112 series modules are approved for two-time reflow processes.

-  Reflow soldering profiles must be selected in accordance with u-blox soldering recommendations described in the ANNA-B112 system integration manual [\[1\]](#). Failure to observe these recommendations can result in severe damage to the product.

7.6 ESD precautions

-  ANNA-B112 series modules are Electrostatic Sensitive Devices that demand the observance of special handling precautions against static damage. Failure to observe these precautions can result in severe damage to the product. See also [Maximum ESD ratings](#).

Proper ESD handling and packaging procedures must be applied throughout the processing, handling, and operation of any application that incorporates the ANNA-B112 module. ESD precautions are particularly relevant when handling the application board on which the module is mounted.

For further information about the handling of ANNA-B112 series modules, see also the ANNA-B112 system integration manual [\[1\]](#).

8 Marking and ordering information

8.1 Product marking

Important product and associated production data is included in a laser mark on all ANNA-B112 modules, as shown in [Figure 9](#).

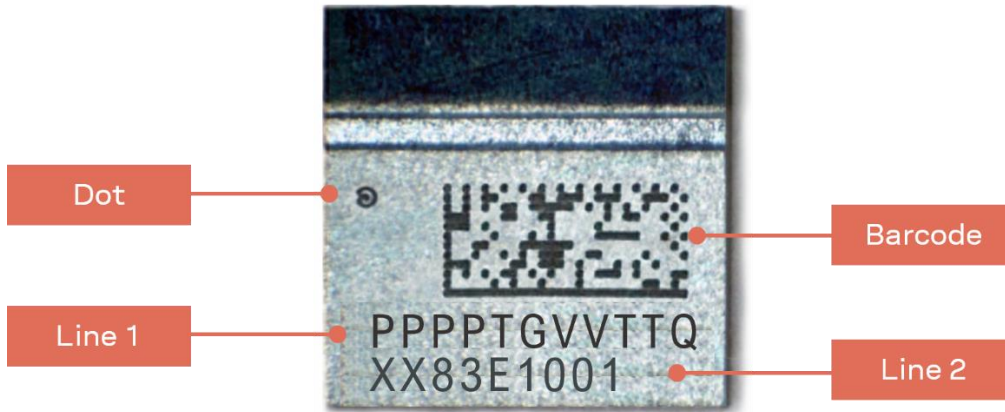

Figure 9: Product marking on the ANNA-B112 module

The product marking provides information that describes the production date, product type number, and version. The exact nomenclature of the product marking is described in [Table 22](#).

Item	Description	Example																																																	
Dot	Pin 1 corner indication for assembly orientation.	-																																																	
Line 1	Product name, major version, and product grade ANNAB112: Product name TT = Major product version Q = Quality grade	ANNAB112 00 B																																																	
Line 2	Minor version and production date XX = Minor product version 8 = Y = Last digit of production year 36 = WW = Week number of production date E1 = EE = Assembly mother lot, last digits 001 = SSS: Assembly sub lot number	00 8 36 E1 001																																																	
2D code	<table border="1"> <thead> <tr> <th>1</th> <th>2</th> <th>3</th> <th>4</th> <th>5</th> <th>6</th> <th>7</th> <th>8</th> <th>9</th> <th>10</th> <th>11</th> <th>12</th> <th>13</th> <th>14</th> <th>15</th> <th>16</th> </tr> </thead> <tbody> <tr> <td>Year</td> <td colspan="6">Assembly mother lot#</td> <td colspan="3">Sub lot#</td> <td colspan="2">Strip#</td> <td colspan="2">X axis</td> <td colspan="2">Y axis</td> </tr> <tr> <td>Example</td> <td>8</td> <td>3</td> <td>6</td> <td>U</td> <td>B</td> <td>E</td> <td>1</td> <td>0</td> <td>0</td> <td>1</td> <td>0</td> <td>1</td> <td>0</td> <td>1</td> <td>0</td> <td>1</td> </tr> </tbody> </table>	1	2	3	4	5	6	7	8	9	10	11	12	13	14	15	16	Year	Assembly mother lot#						Sub lot#			Strip#		X axis		Y axis		Example	8	3	6	U	B	E	1	0	0	1	0	1	0	1	0	1	
1	2	3	4	5	6	7	8	9	10	11	12	13	14	15	16																																				
Year	Assembly mother lot#						Sub lot#			Strip#		X axis		Y axis																																					
Example	8	3	6	U	B	E	1	0	0	1	0	1	0	1	0	1																																			

Table 22: ANNA-B112 marking description

See also

8.2 Product identifiers

Table 23 describes the three product identifiers; specifically, the Product name, Ordering code and Type number.

Format	Description	Nomenclature
Product name	Describes the form factor, platform technology and platform variant. Used mostly in product documentation like this data sheet, the product name represents the most common identity for all u-blox products	PPPPTGVV (Line1, position 1–8)
Ordering code	Comprises the product name – with additional identifiers to describe the major product version and quality grade	PPPPTGVVTTQ (Line1, position 1–11)
Type number	Comprises the product name and ordering code – with additional identifiers to describe minor product versions.	PPPP-TGVV-TTQ-XX (Line1, position 1–11) (Line 2, position 1–2)

Table 23: Product code formats

8.3 Identification codes

Table 24 explains the parts of the product code.

Code	Meaning	Example
PPPP	Form factor	ANNA
TG	Platform (Technology and Generation) T – Dominant technology, For example, W: Wi-Fi, B: Bluetooth G – Generation	B1: Bluetooth Generation 1
VV	Variant based on the same platform; range [00...99]	12: default mounting, with internal antenna
TT	Major Product Version	00: first revision
Q	Quality grade <ul style="list-style-type: none"> • A: Automotive • B: Professional • C: Standard 	B: professional grade
XX	Minor product version (not relevant for certification)	Default value is 00

Table 24: Part identification code

8.4 Ordering information

Ordering Code	Product
ANNA-B112-00B	ANNA-B1 module pre-flashed with u-connectXpress software v1.0.0 for optional use with either an internal or external antenna.
ANNA-B112-01B	ANNA-B1 module pre-flashed with u-connectXpress software v2.0.0 for optional use with either an internal antenna or an external antenna.
ANNA-B112-02B	ANNA-B1 module pre-flashed with u-connectXpress software v4.0.0 for optional use with either an internal antenna or an external antenna.
ANNA-B112-70B	ANNA-B1 module with open CPU architecture and optional use of either an internal or external antenna.

Table 25: Product ordering codes

Appendix

A Glossary

Abbreviation	Definition
ADC	Analog to digital converter
BLE	Bluetooth low energy
BPF	Band pass filter
CTS	Clear to send
ESD	Electro static discharge
FCC	Federal Communications Commission
GATT	Generic ATtribute profile
GPIO	General purpose input/output
IC	Industry Canada
I2C	Inter-integrated circuit
ICS	Inter-IC Sound
LPO	Low power oscillator
MCU	Micro controller unit
MSD	Moisture sensitive device
RF	Radio frequency
RTOS	Real time operating system
SiP	System in package
SPI	Serial peripheral interface
UART	Universal asynchronous receiver/transmitter

Table 26: Explanation of the abbreviations and terms used

Related documents

- [1] ANNA-B112 system integration manual, [UBX-18009821](#)
- [2] u-connectXpress AT commands manual, [UBX-14044127](#)
- [3] u-connectXpress software user guide, [UBX-16024251](#)
- [4] ANNA-B112 EU declaration of conformity, [UBX-18058993](#)
- [5] ANNA-B112 UKCA declaration of conformity, [UBX-22026465](#)
- [6] Product packaging guide, [UBX-14001652](#)

 For product change notifications and regular updates of u-blox documentation, register on our website, www.u-blox.com.

Revision history

Revision	Date	Name	Comments
R01	28-Mar-2018	mwej, kgom	Initial release.
R02	14-May-2018	mwej, kgom	Changed product status to Engineering Sample. Updated main features summary (Table 1) and the block diagram (Figure 1). Updated the countries for modular type approvals.
R03	15-Nov-2018	mwej, hekf, kgom	Changed product status to Initial Production. Updated RoHS compliance from RoHS 2 to RoHS 3. Inserted table of antenna radiation patterns. Updated package thickness and added missing dimensions in the mechanical drawing. Updated the number of units on a reel in section 7.2. Included information about Approved antennas. Added reference to the ANNA-B112 Getting Started Guide. Updated range figures in Table 1. Updated product marking in section 8.1. Updated information about the completed certifications for ETSI (Europe), FCC (USA), IC (Canada), Japan. Updated Tape information in section 7.3. Added Bluetooth qualification listing information i
R04	24-Dec-2018	mwej, hekf	Added information about the completed certification for Taiwan.
R05	2-Apr-2019	mwej, hekf	Added Hardware revision information (page 2). Updated the product ordering codes (Table 25) with software version 2.0.0 Updated Table 1. Replaced "u-blox connectivity software" with "u-connectXpress software" in all instances. Replaced all references to the "ANNA-B112 Getting Started" guide with the new document "u-connectXpress User Guide". Updated the document name of the "u-blox Short Range AT Commands Manual" to the new name - "u-connect AT Commands Manual". Added KCC to Approved antennas. Added information about the completed certification for South Korea.
R06	29-Oct-2019	hekf	Updated Table 1. Changed the current consumption values in Table 14 and also mentioned that they are valid for u-connectXpress software version 2.0.0. Added information about the completed certification for Brazil, Australia/New Zealand and South Africa, and. Removed the mode column in Table 13 for better readability. Added information in Table 8 about grounding pins XL1 and XL2 if the internal RC-oscillator is used with the u-connectXpress software.
R07	25-Mar-2020	hekf	Changed product status to Mass production.
R08	02-Nov-2020	hekf	Changed ESD HBM to 2 kV, CDM to 500 V and highlighted ESD indirect contact discharge in Table 10.
R09	21-Dec-2020	hekf	Clarified the need of antenna strips in combination with integrated antennas in sections 1.1 and 2.2. Added product description and ordering information for the ANNA-B112-70B open CPU variant in sections 1.4 and in 8.4 with associated changes in the Document information.
R10	10-Aug-21	fkru, hisa	Added information about the completed certification for SRRC China Radio Transmission Equipment Type Approval . Added ANNA-B112-02B-00 product. Revised all document cross references and included editorial edits in all chapters.

Revision	Date	Name	Comments
R11	02-Mar-22	hisa, mape, hekf	Changed X and Y axis in Table 22 . Added chapters Throughput characteristics and Latency . Revised product status of ANNA-B112-02B-00 and ANNA-B112-70B-00 module variants to Mass production in Document information . Removed ambiguous description of operating condition ranges in Electrical specifications . Updated information describing Moisture sensitivity levels , Reflow soldering , and ESD precautions . Included other minor editorial changes. Reformatted Block diagram to show component boundaries more clearly.
R12	14-Mar-2023	ctur	Reorganized Qualifications and approvals section with compliance content moved to the ANNA-B112 system integration manual [1] and rationalized information describing Bluetooth qualification . Updated Marking and ordering information .

Contact

For further support and contact information, visit us at www.u-blox.com/support.