



RF PRODUCTS AND SERVICES

Improving SWaP-C with Innovative
GaN on SiC Solutions

The Wolfspeed RF Difference

Unleashing the Power of Possibilities.™

For the past 30 years — first as a division of Cree and now as Wolfspeed — we have only focused on one thing: perfecting wide bandgap semiconductor technology. No one has more experience or expertise in the development and commercialization of Silicon Carbide (SiC) and Gallium Nitride (GaN). As the largest American producer of GaN on SiC RF wafer processing technology, Wolfspeed's GaN HEMTs and MMICs enable enhanced innovation, performance and efficiency across a broad spectrum of RF and microwave applications for both the commercial and military sectors.

Wolfspeed is the industry leader in GaN on SiC research and development. Consistently investing to expand our product portfolio, accelerating the company's progress in developing innovations for telecommunications and aerospace/defense applications.

WOLFSPEED'S GaN SOLUTIONS enable next-generation electronics systems that are the best-in-class in efficiency and performance, including the lowest Failure-in-Time (FIT) rate in the industry.

WOLFSPEED'S LDMOS SOLUTIONS portfolio delivers on the promise of continued innovation for cellular applications such as improved 4G networks and the shift to 5G networks.

WOLFSPEED'S FOUNDRY SERVICES turn your designs into a faster, more reliable reality. As leaders in GaN on SiC MMIC technology, we have the design assistance, testing and support to realize your specifications from initial development to recurring production. Plus, as a volume supplier, we can do it with a focus on fast cycle times, high first-pass design success, and high device reliability.

Each day the world's electronics, industrial and communications sectors become more interconnected by evolving RF technologies. In offering the world's most efficient and highest performing RF devices and Foundry Services, Wolfspeed is making any vision possible.



GaN RF LEADER

Experience

- >200 Billion Field Hours
- >2 GW Shipped

Innovation

- Reliable device performance
- MMIC design advances



LDMOS RF LEADER

- Asymmetric Doherty Transistors
- Integrated RF Power Amplifiers
- Fully Automated Production
- Advanced, Rugged and Stable Solutions



ACCELERATED TIME TO MARKET

Expert Engineers Focused on Supporting Advanced RF Solutions



TRUSTED FOUNDRY

World's Largest Commercial Wide Bandgap Facility



BROAD PORTFOLIO

- Power Density
- Bandwidths
- Breakdown Voltage



Our Custom Solutions/GaN Foundry Services

Wolfspeed's GaN Foundry Services turn your designs into a faster, more reliable reality. As leaders in GaN on SiC MMIC technology, we have the design assistance, testing and support to realize your specifications from initial development to recurring production. Plus, we can do it with a focus on faster cycle times, high rates of first-pass design success, and excellent reliability.

Wolfspeed Advantages

- World's largest dedicated, commercial, WBG-production-device facility
- 100-mm production line
- RF MMIC on-wafer probe/dice
- Category 1A Trusted Foundry with MRL8 Certification
- Microwave reliability labs
- RF application support
- GaN RF online Foundry training course

Processes

	G28V5 MMIC	G28V3 MMIC	G28/40V4 MMIC	G50V3 MMIC
Gate Length	0.15 μm	0.4 μm	0.25 μm	0.4 μm
Bias	28 V	28 V	28 V to 40 V	50 V
Breakdown	>84 V	>84 V	>84 V	>150 V
Density	3.75 W/mm	4.5 W/mm	6 W/mm	8 W/mm
Performance	DC-40 GHz	DC-8 GHz	DC-18 GHz	DC-6 GHz

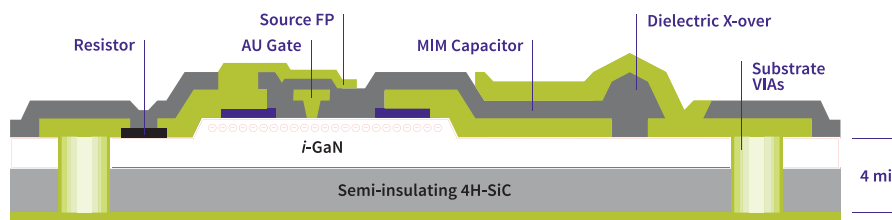

Features

- Dual-metal, 3 μm -thick interconnects
- Thin film and bulk resistors
- MIM capacitors >100 V
- Slot substrate VIAs
- Power FETs and Switch FETs
- EE & Scratch Coat Option

Our Commercial Products

MMIC Power Amplifier Die

In addition to offering FET die, we also offer high-performance, integrated circuits. These GaN on SiC MMIC power amplifiers target applications such as electronic warfare, communications, radar and test instrumentation.

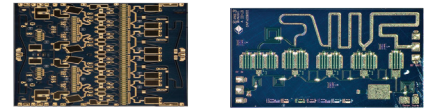

Part Number	Frequency (GHz)	Output Power (W)	Voltage (V)
CMPA0060002D	DC-6.0	2	28
CMPA2735015D	2.7-3.5	15	50
CMPA0060025D	DC-6.0	25	50
CMPA5585025D	5.5-8.5	25	28
CMPA2560025D	2.5-6.0	25	28
CMPA601C025D	6.0-12.0	25	28
CMPA601J025D	6.0-18.0	25	28
CMPA1D1E025D	13.75-14.5	25	40
CMPA2735030D	2.7-3.5	30	50
CMPA5585030D	5.5-8.5	30	28
CMPA2060035D	2.0-6.0	35	28
CMPA901A035D	9.0-10.0	35	28
CMPA1C1D060D	12.7-13.25	60	40
CMPA2735075D	2.7-3.5	75	28

Packaged MMIC Power Amplifiers

This line of GaN on SiC MMICs is matched to 50-ohms in/out for the smallest-sized power amplifiers for a given output power and application. They are matched for specific applications and frequency bands— from L-Band to Ku-Band.

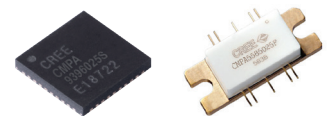

Part Number	Frequency (GHz)	Output Power (W)	Voltage (V)
CMPA0060002F	DC-6.0	2	28
CMPA0060002F1	DC - 6.0	2	28
CMPA0530002S	0.5-3.0	2	28
CMPA0527005F	0.5-2.7	5	50
CMPA2735015S	2.7-3.5	15	50
CMPA901A020S	9.0-10.0	20	28
CMPA0060025F	DC-6.0	25	50
CMPA0060025F1	DC-6.0	25	50
CMPA2560025F	2.5-6.0	25	28
CMPA5259025F/S	5.2- 5.9	25	28
CMPA601C025F	6.0-12.0	25	28



Part Number	Frequency (GHz)	Output Power (W)	Voltage (V)
CMPA1D1E025F	13.75-14.5	25	40
CMPA5585030F	5.5-8.5	30	28
CMPA9396025S	9.3-9.6	30	40
CMPA2735030S	2.7-3.5	30	50
CMPA2060035F1	2.0-6.0	35	28
CMPA901A035F1	9.0-10.0	40	28
CMPA801B030S/F1	7.9-11	40	28
CMPA5259050F/S	5.2-5.9	50	28
CMPA5259050S	5.0-5.9	50	28
CMPA2738060F	2.7-3.8	60	50
CMPA1H1J050F	17.3-19.2	60	28
CMPA2735075F	2.7-3.5	75	28
CMPA3135060S	3.1-3.5	75	50
CMPA1C1D080F	12.75-13.25	90	40
CMPA5259080S	5.0-5.9	110	40
CMPA2935150S	2.9-3.5	150	50

Internally Matched, Packaged Discrete Transistors

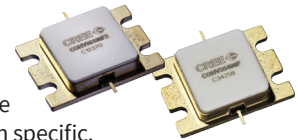

By moving some of the matching from the circuit board closer to the GaN on SiC HEMT bare die, the performance of the packaged transistor improves. As a result of the matching, the frequency of operation becomes application specific. The internal matching also makes the amplifier PCB design easier, especially when the packaged device is matched to 50-ohms on the input and output pins.

Here is a list of products matched for communications and radar applications ranging from L-band through X-band.

Part Number	Frequency (GHz)	Output Power (W)	Voltage (V)
CGHV96050F1	7.9-8.4	50	40
CGHV96050F2	7.9-9.6	50	40
CGHV96100F2	7.9-9.6	100	40
CGHV50200F	4.4-5.0	200	40
CGH31240F	2.7-3.1	240	28
CGH35240F	3.1-3.5	240	28
CGHV38375F	2.75-3.75	400	50
CGHV59350F	5.2-5.9	400	50
CGHV37400F	3.3-3.7	400	50
CGHV31500F	2.7-3.1	500	50
CGHV35400F1	2.9-3.5	500	50

Our Commercial Products

Partially Matched, Packaged Discrete Transistors

Part Number	Frequency (GHz)	Output Power (W)	Voltage (V)
CGHV35060MP	3.1-3.5	60	50
CG2H30070F	0.5-3.0	70	28
CGHV59070F/P	5.2-5.9	70	50
CGH21120F	1.8-2.3	120	28
CGHV35120F	2.7-3.5	120	50
CGHV35150F/P	2.9-3.5	150	50
GTVA311801FA	2.7-3.1	180	50
CGH25120F	2.3-2.7	120	28
CGH21240F	1.8-2.3	240	28
CGHV14250F/P	0.5-1.6	250	50
GTVA355001EC	2.9-3.5	500	50
CGHV14500F/P	0.5-1.8	500	50
CGHV14800F	0.9-1.4	800	50

Unmatched, Packaged Discrete Transistors

For designers wanting high-performance HEMTs with industry-leading reliability, we offer a line of packaged GaN on SiC HEMTs with no internal matching. These are packaged versions of the discrete HEMT die. Packages available include metal-ceramic and plastic overmold.

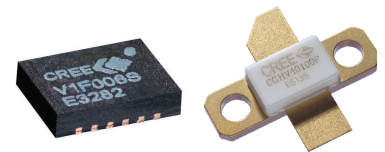

Part Number	Frequency (GHz)	Output Power (W)	Voltage (V)
CGH4006S/P	DC-6.0	6	28
CGHV1F006S	DC-15.0	6	20-40
CGH40010F/P	DC-6.0	10	28
CG2H40010F/P	DC-6.0	10	28
CGH27015F/P	DC-6.0	15	28
CGH35015F/P	DC-6.0	15	28
CGH55015F/P	DC-6.0	15	28
CGHV27015S	DC-6.0	15	50
CGH40025F/P	DC-6.0	25	28
CG2H40025F/P	DC-6.0	25	28
CGHV1F025S	DC-15.0	25	20-40
CGH27030F/P	DC-6.0	30	28
CGH27030S	DC-6.0	30	28
CGHV27030S	DC-6.0	30	50
CGH35030F/P	DC-6.0	30	28
CGH55030F/P	DC-6.0	30	28



Part Number	Frequency (GHz)	Output Power (W)	Voltage (V)
CGHV40030F/P	DC-6.0	30	50
CGH40035F/P	DC-4.0	35	28
CG2H40035F/P	DC-6.0	35	28
CGH40045F/P	DC-4.0	45	28
CG2H40045F/P	DC-4.0	45	28
CGHV40050F/P	DC-4.0	50	50
CGH27060F/P	DC-4.0	60	28
CGHV27060MP	DC-2.7	60	50
CGH35060F/P	3.1-3.5	60	28
CGH40090PP	DC-3.0	90	28
CGHV40100F/P	DC-3.0	100	50
CGH09120F/P	DC-1.0	120	28
CGH40120F/P	DC-3.0	120	28
CG2H40120F/P	DC-3.0	120	28
CGH40180PP	DC-3.0	180	28
CGHV40180F/P	DC-2.0	200	50
CGHV40200PP	DC-3.0	200	50

Our Commercial Products

Discrete Transistor Die

We offer families of GaN on SiC HEMTs for RF designers to customize the performance of their RF power amplifiers. Bare die offer maximum flexibility, making them ideal for designers wanting to make hybrids and modules.

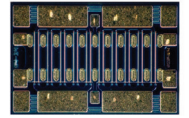

Here is a list of discrete FETs operating at 28, 40 and 50 V with power levels ranging from 6 W to >300 W.



Part Number	Frequency (GHz)	Output Power (W)	Voltage (V)
CGHV1J006D	DC-18.0	6	28-40
CGH60008D	DC-6.0	8	28
CGH60015D	DC-6.0	15	28
CG2H80015D	DC-8.0	15	28
CGHV1J025D	DC-18.0	25	28-40
CGH60030D	DC-6.0	30	28
CG2H80030D	DC-8.0	30	28
CGHV60040D	DC-6.0	40	50
CG2H80045D	DC - 8.0	45	28
CGH60060D	DC-6.0	60	28
CG2H80060D	DC-8.0	60	28
CGHV1J070D	DC-18.0	70	40
CGHV60075D5	DC-6.0	75	50
CGH60120D	DC-6.0	120	28
CG2H80120D	DC-8.0	120	28
CGHV60170D	DC-6.0	170	50
CGHV40320D	DC-6.0	320	50



Don't waste time waiting.

Wolfspeed is enabling the 5G revolution. Our portfolio of 3.5 GHz GaN RF Power solutions empowers systems to offer hundreds of megabits per second of throughput; while also enhancing reliability and reducing latency.

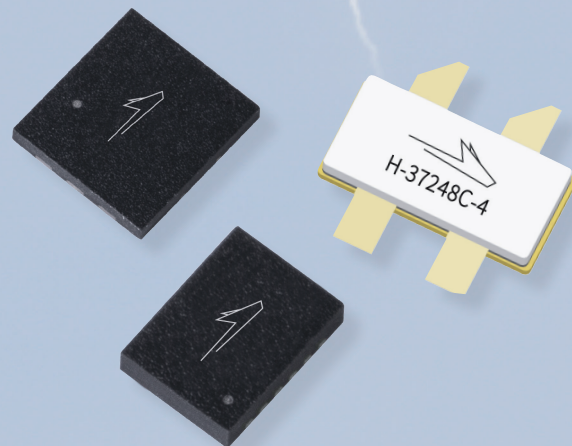

Our Commercial Products

Cellular Infrastructure RF Power Transistors (700 MHz to 4100 MHz)

We offer a broad portfolio of RF power transistors for use in the design of cellular base station amplifiers. Engineered to support all cellular standards and frequency bands, our products are enabling the next generation of 5G cellular solutions with state-of-the-art GaN on SiC and LDMOS transistors. Key features include high-power Doherty designs, ease of use with DPD systems, open-cavity and plastic package options and reference designs.

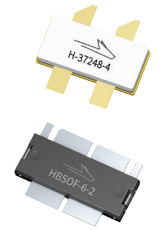

Part Number	Operating Frequency [MHz]	Matching	P1dB Output Power (W)	Gain typ [dB]	Eff typ [%]	P _{out} avg [W]	Test Signal	Supply Voltage typ [V]	Technology	Package Type
700 MHz to 960 MHz										
PTRA094252FC	746-960	I	208	18.5	48.0	89	WCDMA	48	LDMOS	H-37248-4
PTVA082407NF	746-821	I	240	22.5	35.5	80	WCDMA	48	LDMOS	HBSOF-4-1
PTVA092407NF	869-960	I	240	22.0	39.0	80	WCDMA	48	LDMOS	HBSOF-4-1
PTRA083818NF	733-805	I	275	18.0	56.0	81.3	WCDMA	48	LDMOS	HBSOF-6-2
PTRA082808NF	790-820	I/O	280	15.9	44.9	56.2	WCDMA	48	LDMOS	HBSOF-6-2
PTRA093302FC	746-768	I	330	17.3	51.6	79	WCDMA	50	LDMOS	H-37248-4
PTVA084007NF	755-805	I/O	370	23.0	39.0	80	WCDMA	48	LDMOS	HBSOF-4-2
PTRA094858NF	859-960	I/O	400	17.0	52	87	WCDMA	48	LDMOS	HBSOF-6-3
PTRA093818NF	925-960	I/O	415	17.0	52.0	81.3	WCDMA	48	LDMOS	HBSOF-6-2
PTRA084808NF	734-821	I/O	480	18.0	55.0	87	WCDMA	48	LDMOS	HBSOF-6-2
PTRA094808NF	859-960	I/O	480	17.5	52.5	87	WCDMA	48	LDMOS	HBSOF-6-2
PTRA095908NB	925-960	I/O	520	17.5	52	109	WCDMA	48	LDMOS	HB2SOF-6-1
PTRA084858NF	730-960	I/O	615	19	50	87	WCDMA	48	LDMOS	HBSOF-6-3
PTRA097008NB	920-960	I/O	630	19.0	49.0	90	WCDMA	48	LDMOS	HB2SOF-6-1
PTRA087008NB	755-805	I/O	650	18.5	52	107	WCDMA	48	LDMOS	HB2SOF-6-1
PTRA097058NB	730-960	I/O	800	18.4	48	112	WCDMA	48	LDMOS	HB2SOF-6-1
1800 MHz to 1900 MHz										
PXFC191507FC	1805-1990	I/O	150	20.5	31.0	32	WCDMA	28	LDMOS	H-37248G-4/2
PXFE181507FC	1805-1880	I/O	175	20.0	36.0	50	WCDMA	28	LDMOS	H-37248G-4/2
PXAC182002FC	1805-1880	I/O	180	16.7	51.5	28.2	WCDMA	28	LDMOS	H-37248-4
PXFC192207FH	1805-1990	I/O	220	20.0	29.0	50	WCDMA	28	LDMOS	H-37288G-4/2
PXAC182908FV	1805-1880	I/O	240	15.0	51.0	70	WCDMA	28	LDMOS	H-37275G-6/2
PXAC192908FV	1930-1995	I/O	240	14.0	49.0	70	WCDMA	28	LDMOS	H-37275G-6/2
PXAE183708NB	1805-1880	I/O	320	16.0	50.5	54	WCDMA	28	LDMOS	HB2SOF-8-1
PXAD184218FV	1805-1880	I/O	420@P3dB	16.0	51.5	60	WCDMA	28	LDMOS	H-37275G-6/2
GTRA184602FC	1805-1880	I	460@P3dB	15.5	60	80	WCDMA	48	GaN on SiC	H-37248C-4



Cellular Infrastructure RF Power Transistors (700 MHz - 4100 MHz) (Continued)

Part Number	Operating Frequency [MHz]	Matching	P1dB Output Power (W)	Gain typ [dB]	Eff typ [%]	P _{out, avg} [W]	Test Signal	Supply Voltage typ [V]	Technology	Package Type
2000 MHz to 2200 MHz										
PTFC210202FC	2110-2170	I/O	28	21.0	29.0	5	WCDMA	28	LDMOS	H-37248-4
PXAC210552FC	1805-2170	I/O	55	17.2	49.0	8	WCDMA	28	LDMOS	H-37248-4
GTVA220701FA	1805-2170	I	70 @P3dB	22.0	27.0	6.3	LTE	50	GaN on SiC	H-37265J-2
PTAC210802FC	2110-2170	I/O	80	17.0	43.0	5	WCDMA	28	LDMOS	H-37248-4
PXAC200902FC	1805-2170	I/O	90	17.2	50.3	15	WCDMA	28	LDMOS	H-37248-4
PXAC201202FC	1800-2200	I/O	120	16.7	46.0	16	WCDMA	28	LDMOS	H-37248-4
PXAC201602FC	1880-2025	I/O	140	17.7	44.0	22	WCDMA	28	LDMOS	H-37248-4
PXFE211507FC	2110-2170	I/O	172	18.0	35.0	50	WCDMA	28	LDMOS	H-37248G-4/2
GTVA212701FA	2110-2200	I	270 @P3dB	19	38	56.2	WCDMA	48	GaN on SiC	H-87265J-2
PXAC213308FV	2110-2200	I/O	320	16.5	43.5	55	WCDMA	28	LDMOS	H-37275G-6/2
PXAC203302FV	1880-2025	I/O	330	16.5	49.0	56	WCDMA	28	LDMOS	H-37275-4
PXAE213708NB	2110-2200	I/O	400	16.0	52.0	54	WCDMA	28	LDMOS	HB2SOF-8-1
PXAD214218FV	2110-2170	I/O	430	16.0	49.0	56	WCDMA	28	LDMOS	H-37275G-6/2
GTRA214602FC	2110-2170	I	490 @P3dB	14.4	59	80	WCDMA	48	GaN on SiC	H-37248C-4
2300 MHz to 2400 MHz										
PTAC240502FC	2300-2400	I	50	14.3	44.0	10	WCDMA	28	LDMOS	H-37248-4
PXAC241002FC	2300-2400	I/O	100	15.5	45	15	WCDMA	28	LDMOS	H-37248C-4
PXAC241702FC	2300-2400	I/O	150	16.5	52.0	28	WCDMA	28	LDMOS	H-37248-4
PXAC243502FV	2300-2400	I/O	350	15.5	44.0	68	WCDMA	28	LDMOS	H-37275-4
2500 MHz to 2700 MHz										
PTFC260202FC	2495-2690	I/O	25	20.0	30.0	5	WCDMA	28	LDMOS	H-37248-4
PTAC260302FC	2620-2690	I/O	30	15.5	45.0	5.5	WCDMA	28	LDMOS	H-37248H-4
GTRA260502M	2515-2675	I	45 @P3dB	16	57	7.94	WCDMA	48	GaN on SiC	DFN-6.5X7-1
PXAC260602FC	2620-2690	I/O	60	15.7	39.0	5	WCDMA	28	LDMOS	H-37248-4
PXAC261002FC	2496-2690	I/O	100	15.6	46.0	18	WCDMA	28	LDMOS	H-37248-4
PXAC261212FC	2496-2690	I/O	120	15.0	48.0	28	WCDMA	28	LDMOS	H-37248-4
PTFC261402FC	2620-2690	I/O	140	18.0	25.0	5	WCDMA	28	LDMOS	H-37248-4
GTVA261701FA	2620-2690	I	170 @P3dB	17.0	43.0	40	WCDMA	50	GaN on SiC	H-37265J-2
GTVA261802FC	2620-2690	I	170 @P3dB	16.8	43	50	WCDMA	48	GaN on SiC	H-37248C-4
PXAE263708NB	2620-2690	I/O	200	14.0	47.0	57	WCDMA	28	LDMOS	HB2SOF-8-1
PTFC262157FH	2620-2690	I/O	200	19.5	29.0	50	WCDMA	28	LDMOS	H-34288G-4/2
GTRA262802FC	2490-2690	I	250 @P3dB	14	54	38	WCDMA	48	GaN on SiC	H-37248C-4
GTVA262701FA	2620-2690	I	270 @P3dB	17	42	60	WCDMA	48	GaN on SiC	H-87265J-2
GTVA262711FA	2620-2690	I	300 @P3dB	18.0	38.5	70	WCDMA	48	GaN on SiC	H-87265J-2
GTVA263202FC	2620-2690	I	340 @P3dB	17	40	80	WCDMA	48	GaN on SiC	H-37248-4
GTRA263902FC	2495-2690	I	370 @P3dB	13.8	54	56.2	WCDMA	48	GaN on SiC	H-37248C-4
GTRB264318FC	2500-2700	I/O	400 @P3dB	14	50	52.5	WCDMA	48	GaN on SiC	H-37248KC-6/2

Our Commercial Products

Cellular Infrastructure RF Power Transistors (700 MHz to 4100 MHz) (Continued)

Part Number	Operating Frequency [MHz]	Matching	P3dB Output Power (W)	Gain typ [dB]	Eff typ [%]	P _{out} avg [W]	Test Signal	Supply Voltage typ [V]	Technology	Package Type
3400 MHz to 3600 MHz										
GTRA360502M	3400-3800	I	50	15	55	7	WCDMA	48	GaN on SiC	DFN-6.5X7-1
GTRA362002FC	3400-3600	I	200	13.5	42	29	WCDMA	48	GaN on SiC	H-37248C-4
GTRA412852FC	3700-4100	I/O	235	11.5	39	30	WCDMA	48	GaN on SiC	H-37248C-4
GTRA362802FC	3400-3600	I	280	13.5	45.5	44	WCDMA	48	GaN on SiC	H-37248C-4
GTRA364002FC	3400-3600	I	400	13	40	50	WCDMA	48	GaN on SiC	H-37248C-4
GTRA384802FC	3600 -3800	I	400	12	44	63	WCDMA	48	GaN on SiC	H-37248C-4
GTRA374902FC	3600-3700	I	450	12	37.5	63	WCDMA	48	GaN on SiC	H-37248C-4

General Purpose RF Transistors (900 MHz to 5000 MHz)

Our general-purpose transistors are unmatched for flexibility in use over a broad frequency range while providing high-power outputs. These products offer high gain, efficiency and linearity performance in a cost-effective overmold plastic package.



Product	Operating Frequency [MHz]	Matching	P1dB Output Power (W)	Gain typ [dB]	Eff typ [%]	P _{out} avg [W]	Test Signal	Supply Voltage typ [V]	Technology	Package Type
PTFC270051M	900-2700	NO	7.3	20.0	60.0	-	CW @2170	28	LDMOS	SON-10
WSGPA01	UP TO 5 GHZ	NO	10 @P3dB	18	19	26.5	WCDMA	48	GaN on SiC	DFN-3X4-1
PTFC270101M	900-2700	NO	12	20.0	60.0	-	CW @2170	28	LDMOS	SON-10
PTVA120121M	500-1400	NO	12	21.0	65.0	15	CW	50	LDMOS	SON-10
PTVA120252MT	500-1400	NO	25	19.8	64.0	-	CW	50	LDMOS	SON-16

Integrated RF Power Amplifiers (700 MHz to 2200 MHz)

These two-stage integrated amplifiers are designed to provide high gain and on-chip matching for broadband performance. They are suitable for use in both driver and output stage amplifier applications.



Product	Operating Frequency [MHz]	Matching	P1dB Output Power (W)	Gain typ [dB]	Eff typ [%]	P _{out} avg [W]	Test Signal	Supply Voltage typ [V]	Technology	Package Type
PTGA090304MD	575-960	I/O	15+15	32	19	3.9	WCDMA	50	LDMOS	HB1DSO-14-4
PTMC210204MD	1805-2200	I/O	10+10	30.5	19	2.5	WCDMA	28	LDMOS	HB1DSO-14-1
PTMC210404MD	1805-2200	I/O	20+20	31.5	19.3	5	WCDMA	28	LDMOS	HB1DSO-14-1
PTNC210604MD	1805-2200	I/O	20+40	27	37	10	WCDMA	28	LDMOS	HB1DSO-14-4

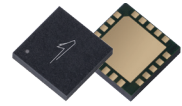

RF Power Amplifier Modules for mMIMO Systems (2500 MHz to 4000 MHz)

Product	Operating Frequency [MHz]	Matching	P3dB Output Power (W)	Gain typ [dB]	Eff typ [%]	P _{OUT} avg [W]	Test Signal	Supply Voltage typ [V]	Technology	Package Type
WSGPA01	UP TO 5 GHz	NO	10	18	19	26.5	WCDMA	48	GaN on SiC	PG-DFN-3X4-1
WS1A2639	2496-2690	I	50	16.5	57	38.5	WCDMA	48	GaN on SiC	PG-LGA-6X6-2
WS1A3640	3300-3800	I	60	14	54	39.5	WCDMA	48	GaN on SiC	PG-LGA-6X6-2
WS1A3940	3700-3980	I	60	13.5	52	39.5	WCDMA	48	GaN on SiC	PG-LGA-6X6-2

UHF, L-Band & Broadcast RF Power Transistors (400 MHz to 1400 MHz)

For designers wanting high-performance HEMTs with industry-leading reliability, we offer a line of packaged GaN on SiC HEMTs with no internal matching. These are packaged versions of the discrete HEMT die. Packages available include metal-ceramic and plastic overmold.



Product	Operating Frequency [MHz]	Matching	P3dB Output Power (W)	Gain typ [dB]	Eff typ [%]	P _{OUT} avg [W]	Test Signal	Supply Voltage typ [V]	Technology	Package Type
PTVA030121EA	390-450	NO	12	25.0	69.0	–	PULSED	50	LDMOS	H-36265-2
PTVA120151EA	1200-1400	I/O	15	17.0	50	15	PULSED	36	LDMOS	H-36265-2
PTVA120251EA	500-1400	NO	30	16.0	56.0	–	PULSED	50	LDMOS	H-36265-2
PTVA120501EA	1200-1400	I	54	16.5	55.0	–	PULSED	50	LDMOS	H-36265-2
PTVA102001EA	1030/1090	I/O	200	18.0	57.0	–	PULSED	50	LDMOS	H-36265-2
PTVA042502EC	470-806	I	250	19.0	25.5	55	DVB-T	50	LDMOS	H-36248-4
PTVA042502FC	470-806	I	250	19.0	25.5	55	DVB-T	50	LDMOS	H-37248-4
PTVA122501EC	1200-1400	I	250	13.0	48.5	250	PULSED	36	LDMOS	H-36248-2
PTVA043502EC	470-860	I/O	350	18.0	29.5	70	DVB-T	50	LDMOS	H-36248-4
PTVA043502FC	470-860	I/O	350	18.0	29.5	70	DVB-T	50	LDMOS	H-37248-4
GTVA123501FA	1200-1400	I	370	18.0	72.0	–	PULSED	50	GaN on SiC	H-37265J-2
PTVA123501EC	1200-1400	I/O	375	17.0	55.0	–	PULSED	50	LDMOS	H-36248-2
PTVA123501FC	1200-1400	I/O	375	17.0	55.0	–	PULSED	50	LDMOS	H-37248-2
PTVA035002EV	390-450	NO	400	19.5	65.0	–	PULSED	50	LDMOS	H-36275-4
GTVA104001FA	960-1215	I	410	18.5	70.0	–	PULSED	50	GaN on SiC	H-37265J-2
PTVA104501EH	960-1215	I/O	450	17.0	57.0	–	PULSED	50	LDMOS	H-36288-2
GTVA126001FC	1200-1400	I	610	18.0	70.0	–	PULSED	50	GaN on SiC	H-37248-2
PTVA047002EV	470-806	I	700	17.5	29.0	130	DVB-T	50	LDMOS	H-36275-4
PTVA127002EV	1200-1400	I/O	700	16.0	56.0	–	PULSED	50	LDMOS	H-36275-4
GTVA107001FC	960-1215	I	750	17.0	70.0	–	PULSED	50	GaN on SiC	H-37248-2
PTVA101K02EV	1030/1090	I	920	18.0	56.0	–	PULSED	50	LDMOS	H-36275-4
GTVA101K42EV-V1	960-1215	I	1400	17.0	68.0	–	PULSED	50	GaN on SiC	H36275-4

Our Product Solutions

RADAR Line Up

Need kilowatts of power? We have devices for each stage of amplification - pre-driver, driver and output stages. Here are some line up suggestions for popular radar bands. If you do not see your frequency band from the line ups below, then feel free to contact us for recommendations for radar solutions from UHF to X-Band.

L-BAND Solutions $V_{DD} = 50\text{ V}$

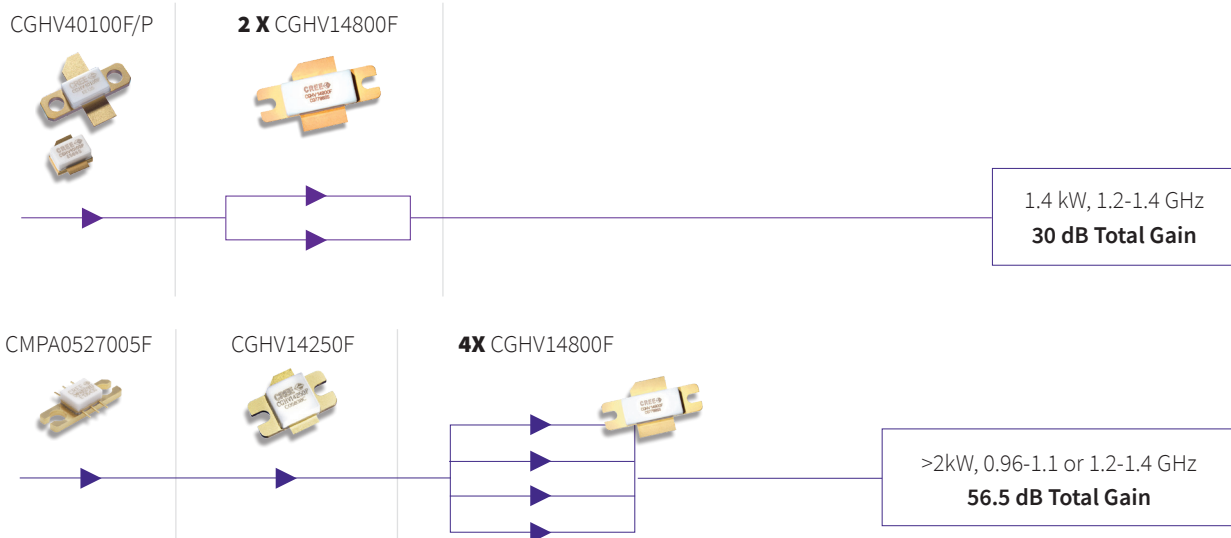

S-BAND Solutions $V_{DD} = 50\text{ V}$

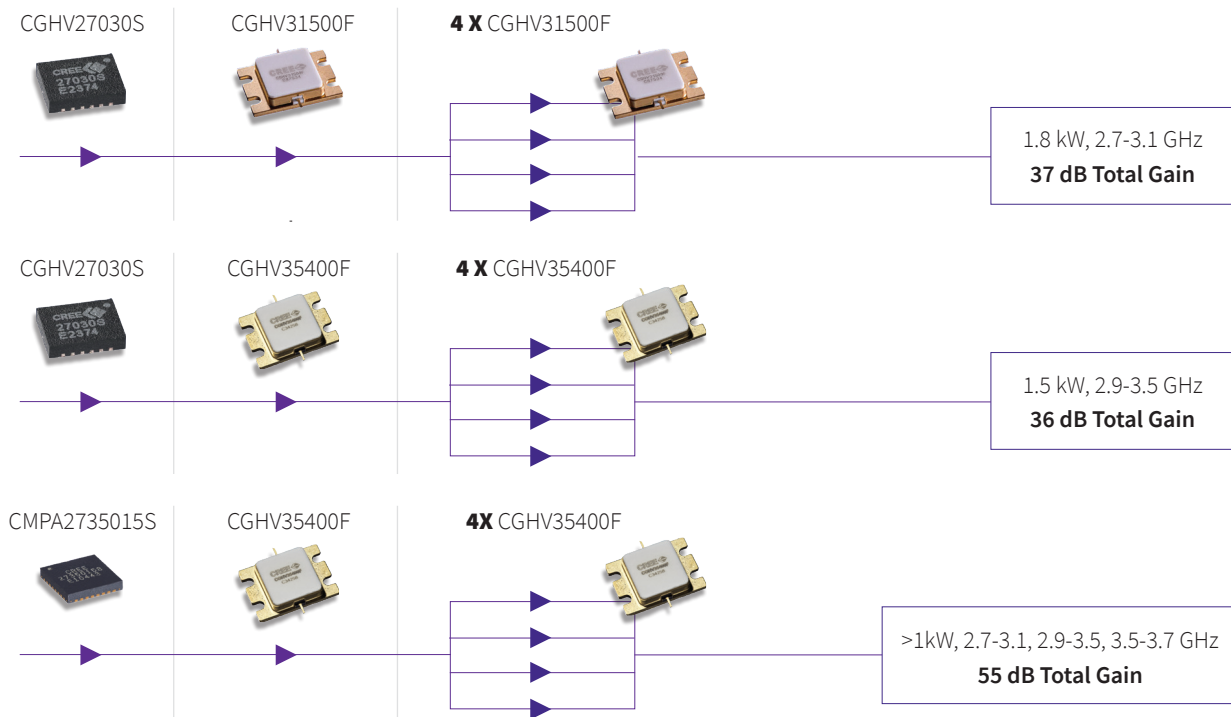



C-BAND Solutions $V_{DD} = 50\text{ V}$

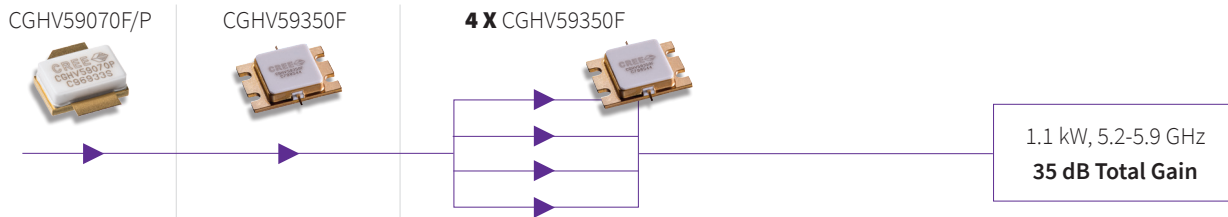

SatCom, $V_{DD} = 40\text{ V}$

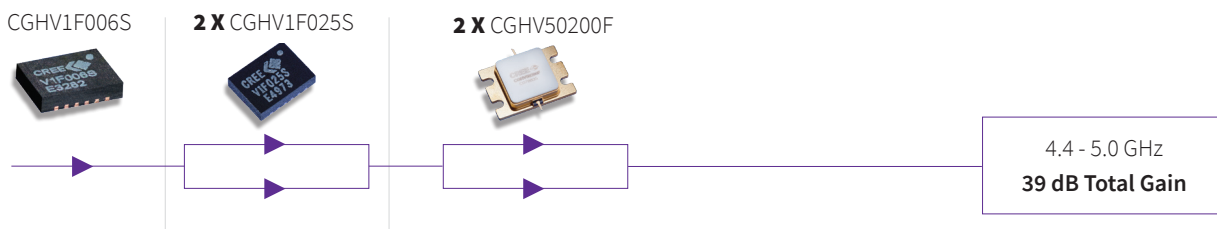

X-BAND Solutions $V_{DD} = 40\text{ V}$

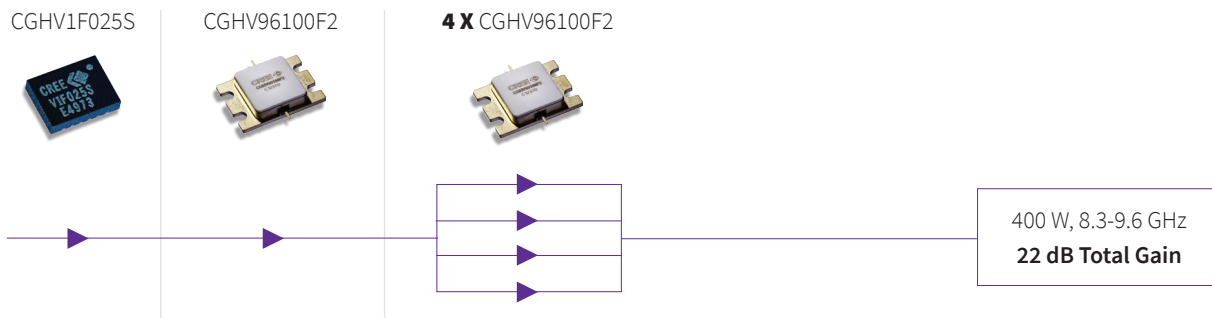

MILCOM Line Up

In addition to recommendations for Radar power amplifier solutions, we offer line ups for several other power amplifier applications. One example is this solution for tactical radios with operating frequencies from 0.5-2.7 GHz. This is a linear communications amplifier solution using unmatched discrete GaN HEMTs.

100W $V_{DD} = 50 V$

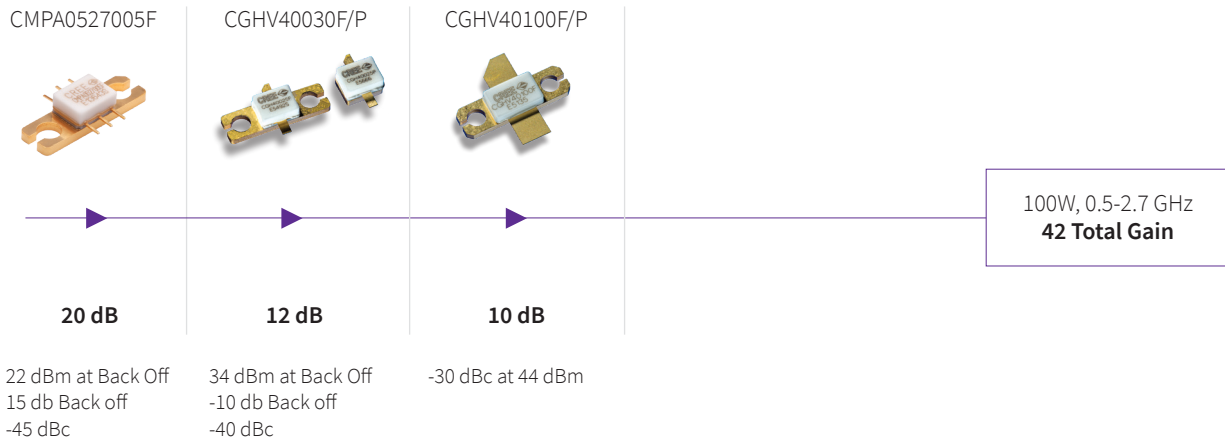

Broadband Solutions, $V_{DD} = 28 V$

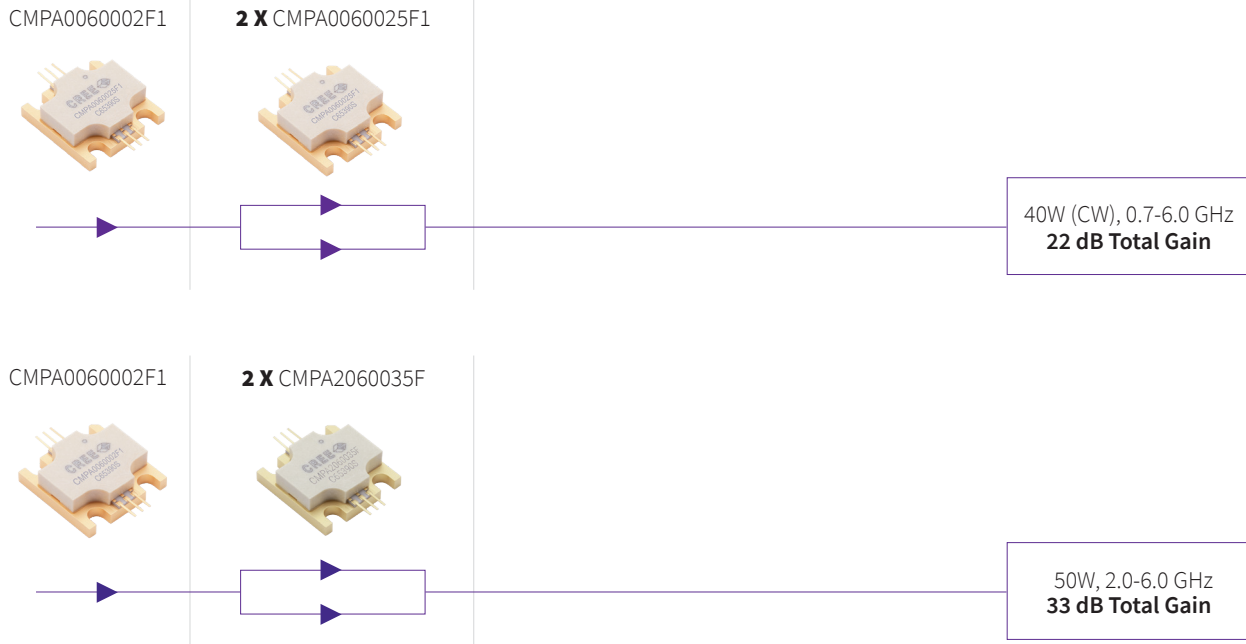



Our Package Types

Thermally-Enhanced, Open-Cavity Ceramic

TEPAC 248 Family

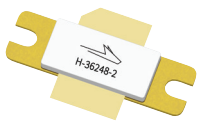

H-36248-2



H-37248-2

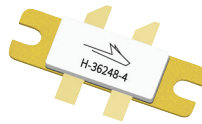

H-36248-4



H-37248-4

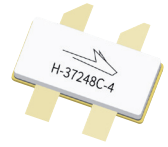

H-37248C-4



H-37248H-4

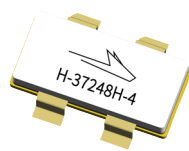

H-37248H-4
(formed leads)



H-37248G-4/2

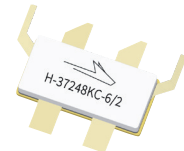

H-37248KC-6/2

TEPAC 265 Family

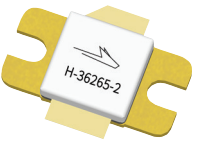

H-36265-2



H-37265-2



H-37265J-2



H-87265J-2

TEPAC 275 Family

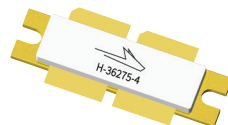

H-36275-4

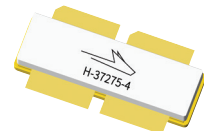

H-37275-4

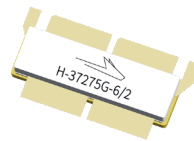

H-37275G-6/2

TEPAC 288 Family



H-37288G-4/2

Our Package Types

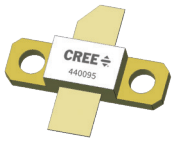

440095



440109



440117



440133



440161



440162



440166



440193



440196



440199



440201



440206



440208



440210

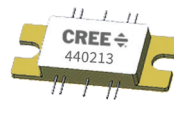

440213

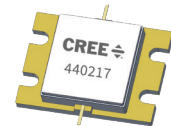

440217



440223



440219



780019



CMPA0060025F



Molded Plastic



SON-10



SON-16

TO270 Family

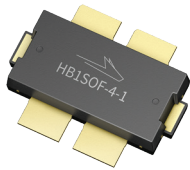

HB1SOF-4-1



HB1DSO-4-1



HB1DSO-14-4



HB1SOF-4-2

TO288 Family

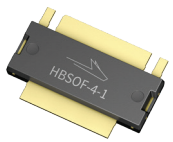

HBSOF-4-1



HBSOF-6-2



HBSOF-6-3



HBSOF-4-2

TO275 Family



HB2SOF-6-1

QFN/DFN Family



OMP-20L



440203



3X4 DFN



HB2SOF-8-1



PG-DFN-3X4-1



PG-DFN-4X4.5-1



PG-DFN-6.5X7-1



PG-LGA-6X6-2

Wolfspeed[®]