

## 6-W STEREO AUDIO POWER AMPLIFIER

### FEATURES

- TDA1517P Compatible
- High Power Outputs (6 W/Channel)
- Surface Mount Availability 20-Pin Thermal SOIC PowerPAD™
- Thermal Protection
- Fixed Gain: 20 dB
- Mute and Standby Operation
- Supply Range: 9.5 V - 18 V

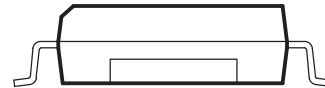
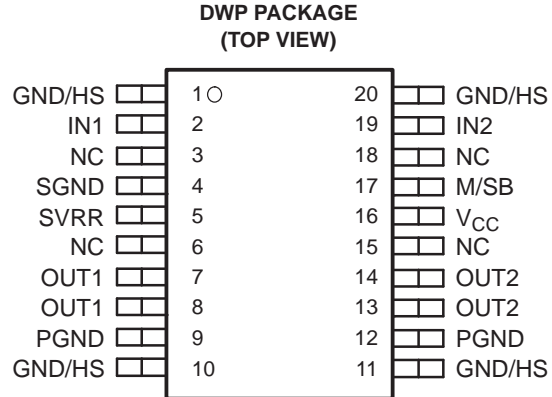
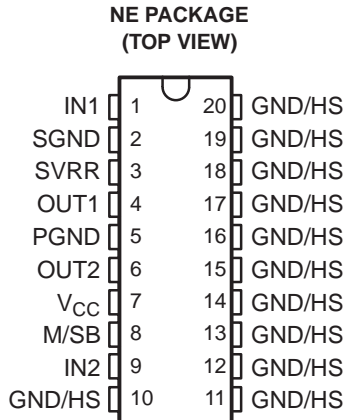

Cross Section View Showing PowerPAD

NC – No internal connection

### DESCRIPTION

The TPA1517 is a stereo audio power amplifier that contains two identical amplifiers capable of delivering 6 W per channel of continuous average power into a 4-Ω load at 10% THD+N or 5 W per channel at 1% THD+N. The gain of each channel is fixed at 20 dB. The amplifier features a mute/standby function for power-sensitive applications. The amplifier is available in the PowerPAD™ 20-pin surface-mount thermally-enhanced package (DWP) that reduces board space and facilitates automated assembly while maintaining exceptional thermal characteristics. It is also available in the 20-pin thermally enhanced DIP package (NE).

### AVAILABLE OPTIONS

T <sub>A</sub>	PACKAGED DEVICES <sup>(1)</sup>	
	THERMALLY ENHANCED PLASTIC DIP	THERMALLY ENHANCED SURFACE MOUNT (DWP) <sup>(2)</sup>
-40°C to 85°C	TPA1517NE	TPA1517DWP <sup>(2)</sup>

- (1) For the most current package and ordering information, see the Package Option Addendum at the end of this document, or see the TI Web site at [www.ti.com](http://www.ti.com).
- (2) The DWP package is available taped and reeled. To order a taped and reeled part, add the suffix R (e.g., TPA1517DWPR).



Please be aware that an important notice concerning availability, standard warranty, and use in critical applications of Texas Instruments semiconductor products and disclaimers thereto appears at the end of this data sheet.

PowerPAD is a trademark of Texas Instruments.



These devices have limited built-in ESD protection. The leads should be shorted together or the device placed in conductive foam during storage or handling to prevent electrostatic damage to the MOS gates.

### Terminal Functions

TERMINAL			I/O	DESCRIPTION
NAME	DWP NO.	NE NO.		
IN1	2	1	I	IN1 is the audio input for channel 1.
SGND	4	2	I	SGND is the input signal ground reference.
SVRR	5	3		SVRR is the midrail bypass.
OUT1	7, 8	4	O	OUT1 is the audio output for channel 1.
PGND	9, 12	5		PGND is the power ground reference.
OUT2	13, 14	6	O	OUT2 is the audio output for channel 2.
V <sub>CC</sub>	16	7	I	V <sub>CC</sub> is the supply voltage input.
M/SB	17	8	I	M/SB is the mute/standby mode enable. When held at less than 2 V, this signal enables the TPA1517 for standby operation. When held between 3.5 V and 8.2 V, this signal enables the TPA1517 for mute operation. When held above 9.3 V, the TPA1517 operates normally.
IN2	19	9	I	IN2 is the audio input for channel 2.
GND/HS	1, 10, 11, 20	10-20		GND/HS are the ground and heatsink connections. All GND/HS terminals are connected directly to the mount pad for thermal-enhanced operation.

### ABSOLUTE MAXIMUM RATINGS

over operating free-air temperature range (unless otherwise noted)

	UNIT
V <sub>CC</sub> Supply voltage	22 V
V <sub>I</sub> Input voltage (IN1, IN2)	22 V
Continuous total power dissipation	Internally limited (See Dissipation Rating Table)
T <sub>A</sub> Operating free-air temperature range	-40°C to 85°C
T <sub>J</sub> Operating junction temperature range	-40°C to 150°C
T <sub>stg</sub> Storage temperature range	-65°C to 85°C

### DISSIPATION RATING TABLE

PACKAGE	T <sub>A</sub> ≤ 25°C	DERATING FACTOR	T <sub>A</sub> = 70°C	T <sub>A</sub> = 85°C
DWP <sup>(1)</sup>	2.94 W	23.5 mW/°C	1.88 W	1.53 W
NE <sup>(1)</sup>	2.85 W	22.8 mW/°C	1.82 W	1.48 W

(1) See the Texas Instruments document, *PowerPAD Thermally Enhanced Package Application Report* (literature number SLMA002), for more information on the PowerPAD package. The thermal data was measured on a PCB layout based on the information in the section entitled *Texas Instruments Recommended Board for PowerPAD* on page 33 of the before mentioned document.

### RECOMMENDED OPERATING CONDITIONS

	MIN	NOM	MAX	UNIT
V <sub>CC</sub> Supply voltage	9.5		18	V
T <sub>A</sub> Operating free-air temperature	-40		85	°C

**ELECTRICAL CHARACTERISTICS**
 $V_{CC} = 12\text{ V}$ ,  $T_A = 25^\circ\text{C}$  (unless otherwise noted)

PARAMETER		TEST CONDITIONS	MIN	TYP	MAX	UNIT
$I_{CC}$	Supply current			45	80	mA
$V_{O(DC)}$	DC output voltage	See Note (1)		6		V
$V_{(M/SB)}$	Voltage on M/SB terminal for normal operation			9.6		V
$V_{O(M)}$	Mute output voltage	$V_I = 1\text{ V (max)}$		2		mV
$I_{CC(SB)}$	Supply current in standby mode			7	100	$\mu\text{A}$

(1) At  $9.5\text{ V} < V_{CC} < 18\text{ V}$  the DC output voltage is approximately  $V_{CC}/2$ .

**OPERATING CHARACTERISTIC**
 $V_{CC} = 12\text{ V}$ ,  $R_L = 4\Omega$ ,  $f = 1\text{ kHz}$ ,  $T_A = 25^\circ\text{C}$ 

PARAMETER		TEST CONDITIONS	MIN	TYP	MAX	UNIT
$P_O$	Output power <sup>(1)</sup>	THD = 0.2%		3		W
		THD = 10%		6		
SNR	Signal-to-noise ratio			84		dB
THD	Total harmonic distortion	$P_O = 1\text{ W}$ , $R_L = 8\Omega$ , $f = 1\text{ kHz}$		0.1%		
$I_{O(SM)}$	Non-repetitive peak output current			4		A
$I_{O(RM)}$	Repetitive peak output current			2.5		A
	Low-frequency roll-off	3 dB		45		Hz
	High-frequency roll-off	1 dB	20			kHz
	Supply ripple rejection ratio	M/SB = On, $f = 1\text{ kHz}$		-65		dB
$Z_I$	Input impedance			60		$\text{k}\Omega$
$V_n$	Noise output voltage <sup>(2)</sup>	$R_s = 0$ , M/SB = On		50		$\mu\text{V(rms)}$
		$R_s = 10\text{ k}\Omega$ , M/SB = On		70		$\mu\text{V(rms)}$
		M/SB = Mute		50		$\mu\text{V(rms)}$
	Channel separation	$R_s = 10\text{ k}\Omega$		-58		dB
	Gain		18.5	20	21	
	Channel balance			0.1	1	dB

(1) Output power is measured at the output terminals of the IC.

(2) Noise voltage is measured in a bandwidth of 20 Hz to 20 kHz.

**ELECTRICAL CHARACTERISTICS**
 $V_{CC} = 14.5\text{ V}$ ,  $T_A = 25^\circ\text{C}$  (unless otherwise noted)

PARAMETER		TEST CONDITIONS	MIN	TYP	MAX	UNIT
$I_{CC}$	Supply current			50	90	mA
$V_{O(DC)}$	DC output voltage	See Note (1)		7.25		V
$V_{(M/SB)}$	Voltage on M/SB terminal for normal operation			9.6		V
$V_{O(M)}$	Mute output voltage	$V_I = 1\text{ V (max)}$		2		mV
$I_{CC(SB)}$	Supply current in standby mode			7	100	$\mu\text{A}$

(1) At  $9.5\text{ V} < V_{CC} < 18\text{ V}$  the DC output voltage is approximately  $V_{CC}/2$ .

**OPERATING CHARACTERISTIC**

$V_{CC} = 14.5\text{ V}$ ,  $R_L = 4\Omega$ ,  $f = 1\text{ kHz}$ ,  $T_A = 25^\circ\text{C}$

PARAMETER		TEST CONDITIONS	MIN	TYP	MAX	UNIT
P <sub>O</sub>	Output power <sup>(1)</sup>	THD = 0.2%		4.5		W
		THD < 10%		6		W
SNR	Signal-to-noise ratio			84		dB
THD	Total harmonic distortion	P <sub>O</sub> = 1 W		0.1%		
I <sub>O(SM)</sub>	Non-repetitive peak output current			4		A
I <sub>O(RM)</sub>	Repetitive peak output current			2.5		A
	Low-frequency roll-off	3 dB		45		Hz
	High-frequency roll-off	1 dB	20			kHz
	Supply ripple rejection ratio	M/SB = On		-65		dB
Z <sub>i</sub>	Input impedance			60		kΩ
V <sub>n</sub>	Noise output voltage <sup>(2)</sup>	R <sub>s</sub> = 0, M/SB = On		50		μV(rms)
		R <sub>s</sub> = 10 kΩ, M/SB = On		70		μV(rms)
		M/SB = Mute		50		μV(rms)
	Channel separation	R <sub>s</sub> = 10 kΩ		-58		dB
	Gain		18.5	20	21	dB
	Channel balance			0.1	1	dB

- (1) Output power is measured at the output terminals of the IC.
- (2) Noise voltage is measured in a bandwidth of 22 Hz to 22 kHz.

**TYPICAL CHARACTERISTICS**

**Table of Graphs**

			FIGURE
I <sub>CC</sub>	Supply current	vs Supply voltage	1
	Power supply rejection ratio	vs Frequency	2, 3
THD + N	Total harmonic distortion plus noise	V <sub>CC</sub> = 12 V vs Frequency	4, 5, 6
		V <sub>CC</sub> = 12 V vs Power output	10, 11
		V <sub>CC</sub> = 14.5 V vs Frequency	7, 8, 9
		V <sub>CC</sub> = 14.5 V vs Power output	12, 13
	Crosstalk	vs Frequency	14, 15
	Gain	vs Frequency	16
	Phase	vs Frequency	16
V <sub>n</sub>	Noise voltage	vs Frequency	17, 18
P <sub>O</sub>	Output power	vs Supply voltages Load resistance	19, 20
P <sub>D</sub>	Power dissipation	vs Output power	21, 22

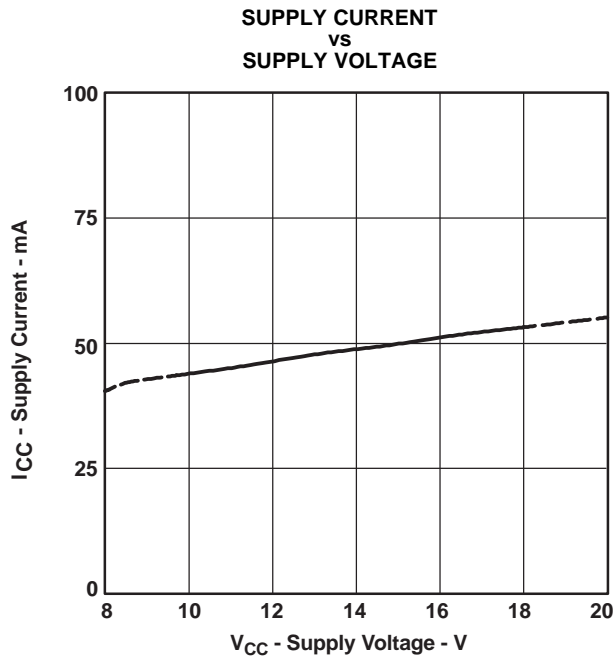

Figure 1.

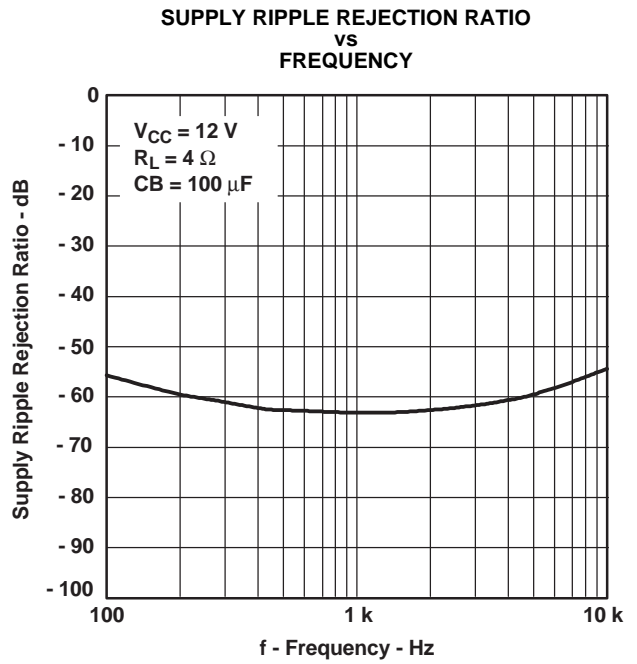

Figure 2.

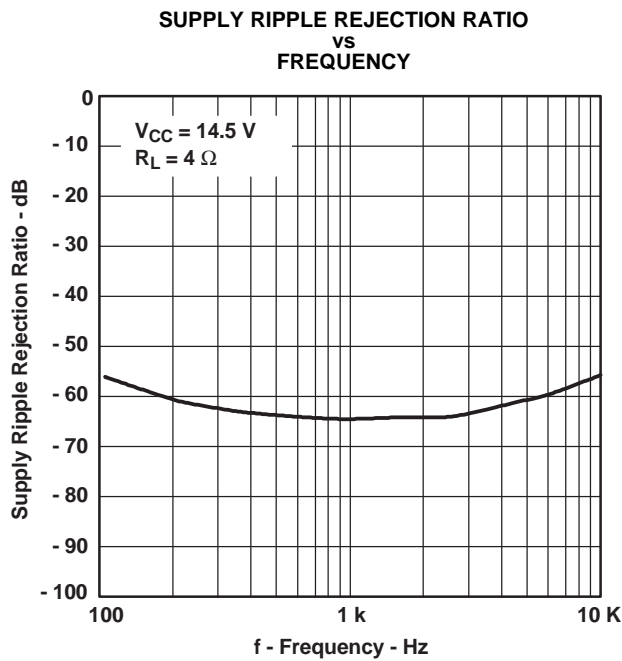

Figure 3.

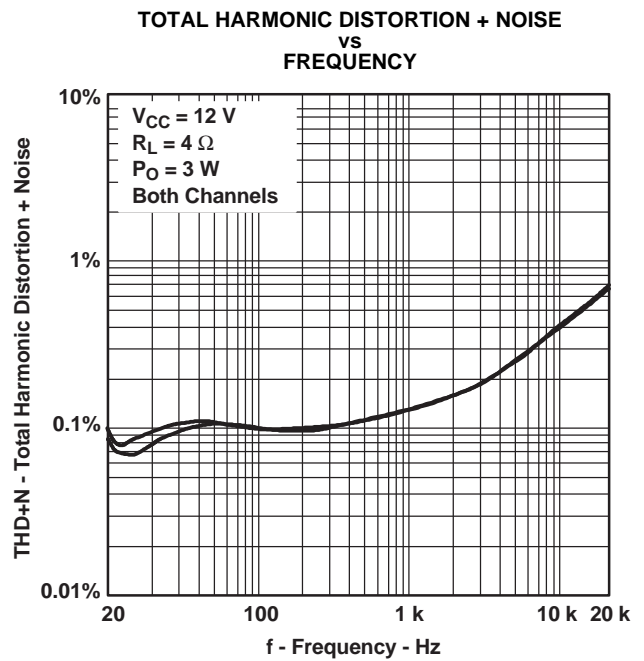

Figure 4.

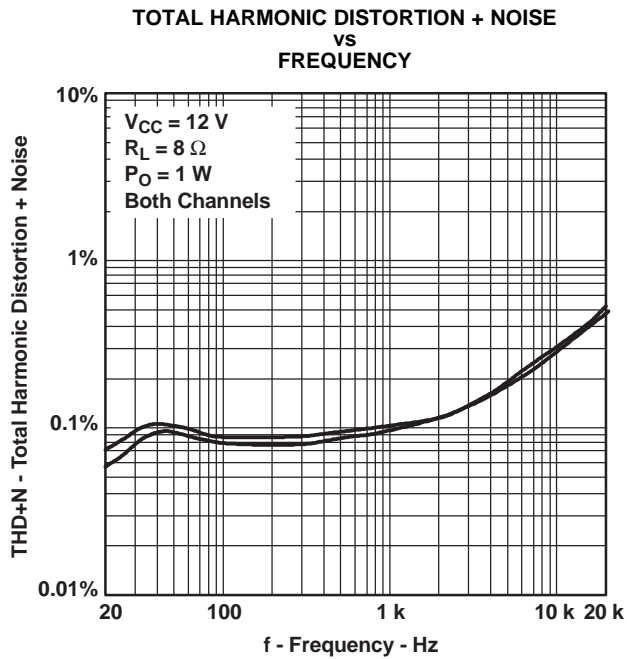

Figure 5.

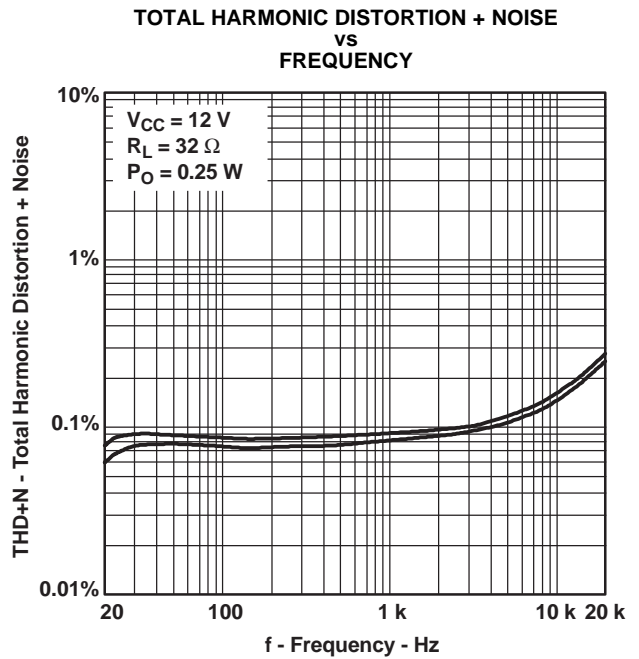

Figure 6.

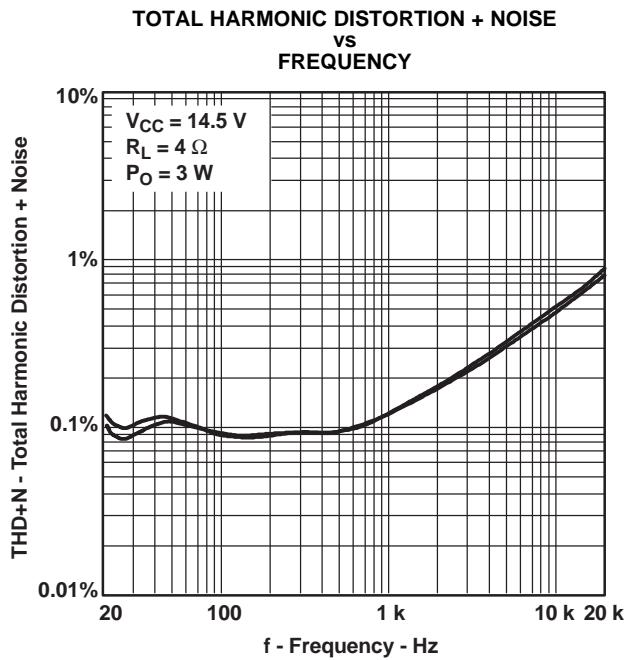

Figure 7.

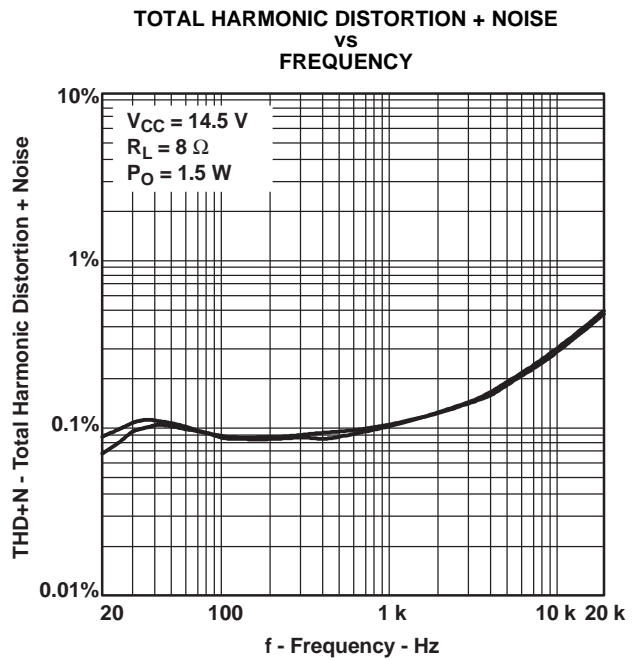

Figure 8.

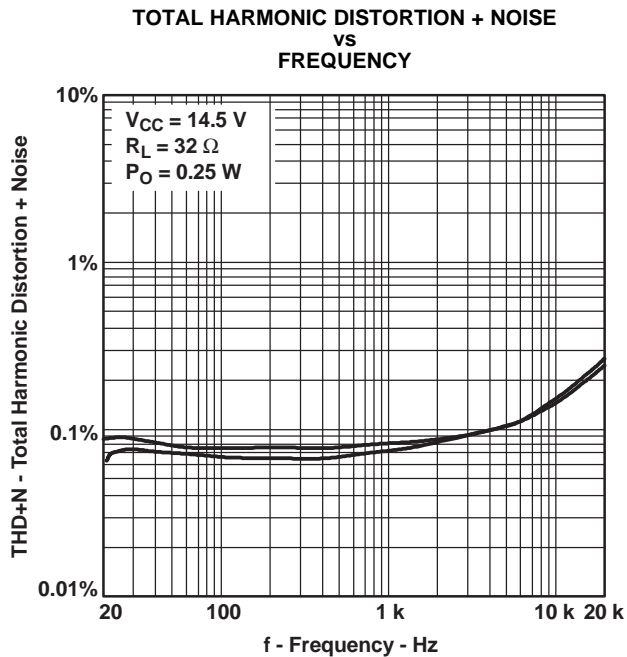

Figure 9.

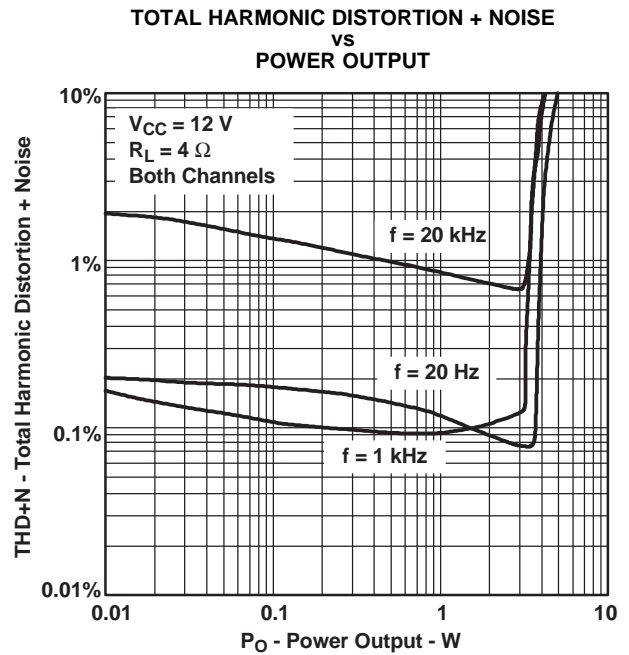

Figure 10.

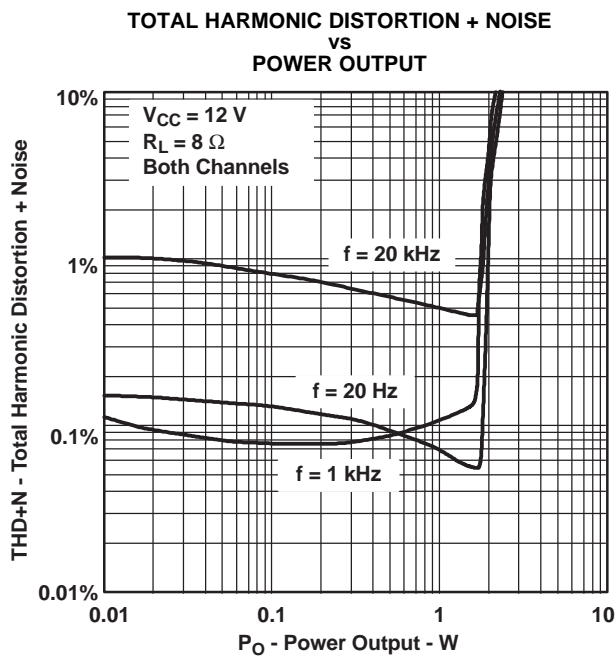

Figure 11.

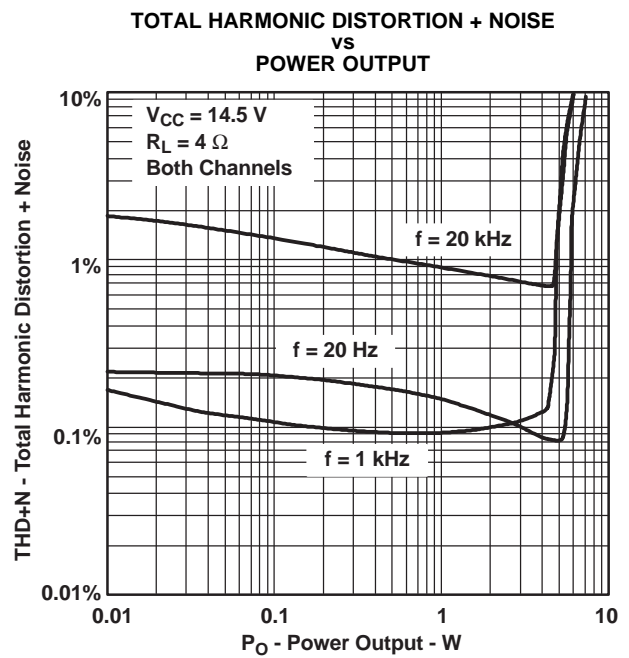

Figure 12.

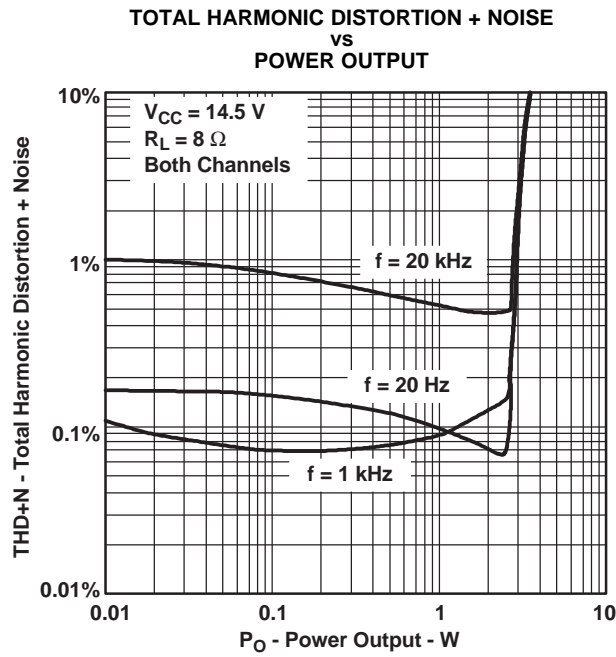

Figure 13.

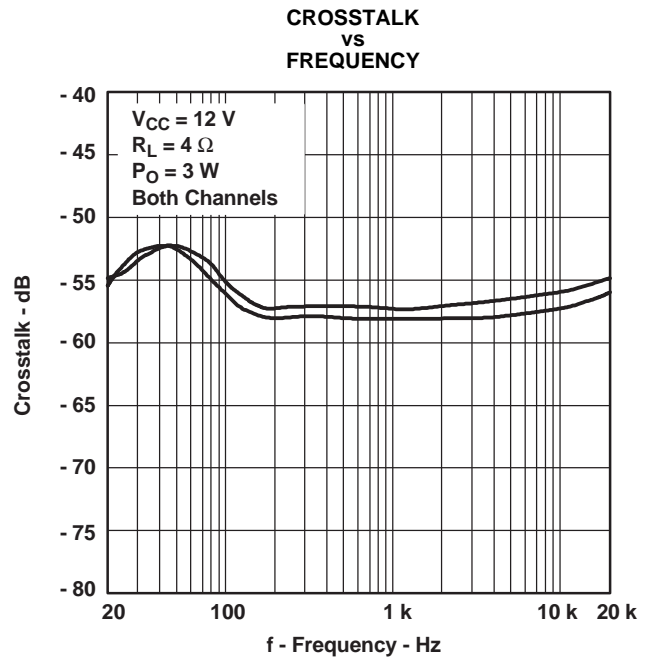

Figure 14.

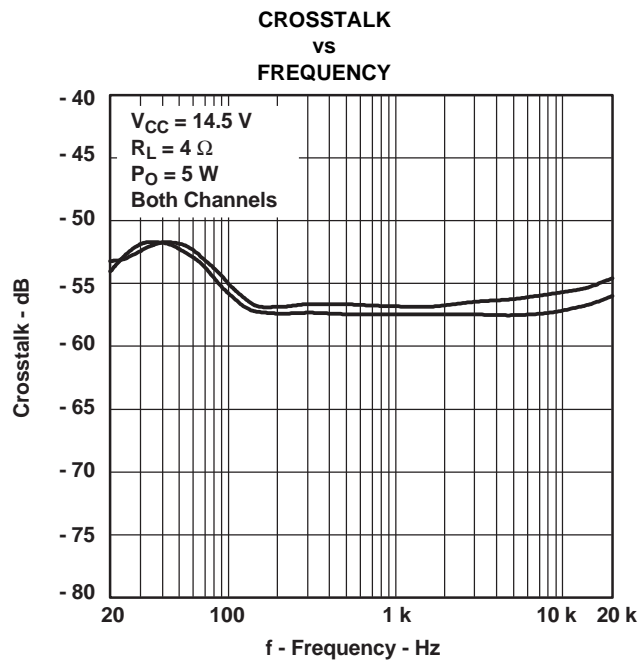

Figure 15.



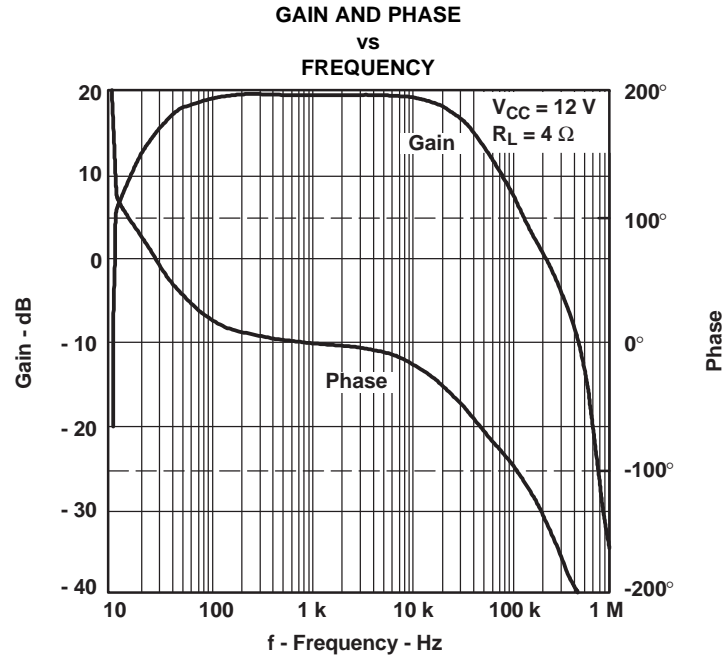

Figure 16.

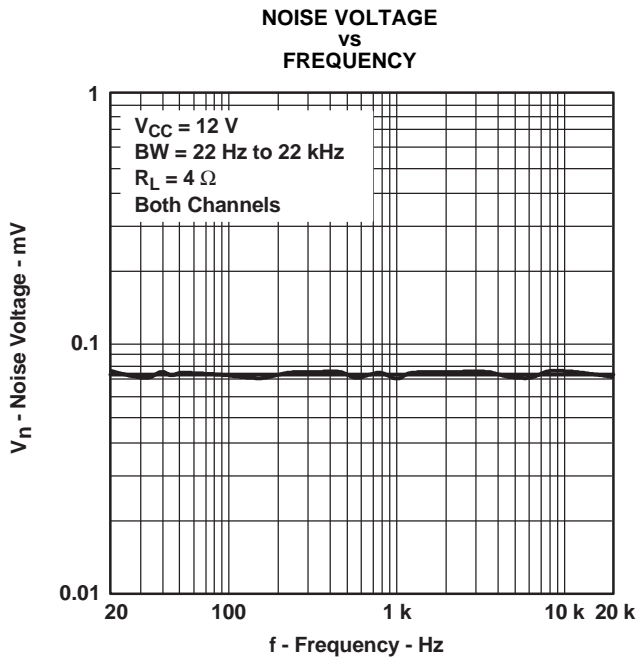

Figure 17.

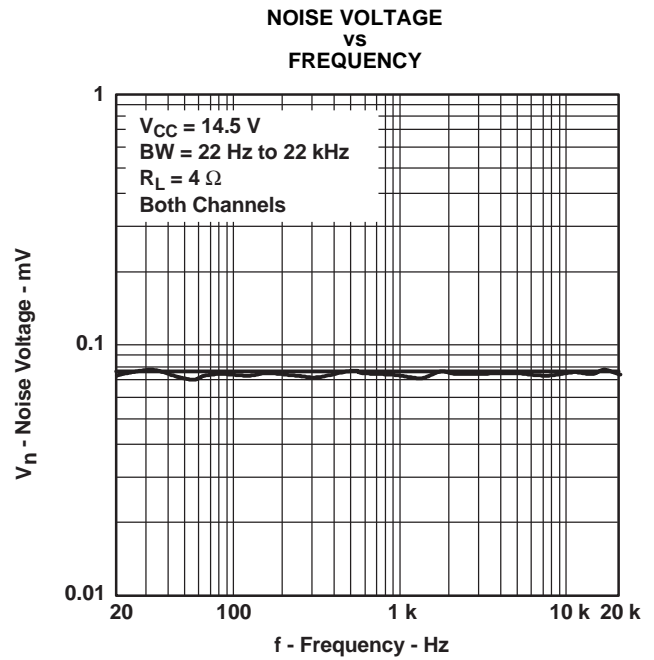

Figure 18.

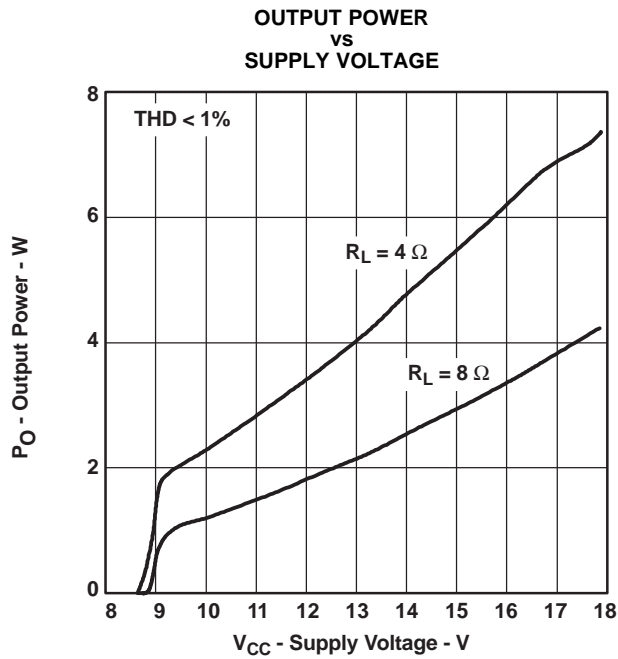

Figure 19.

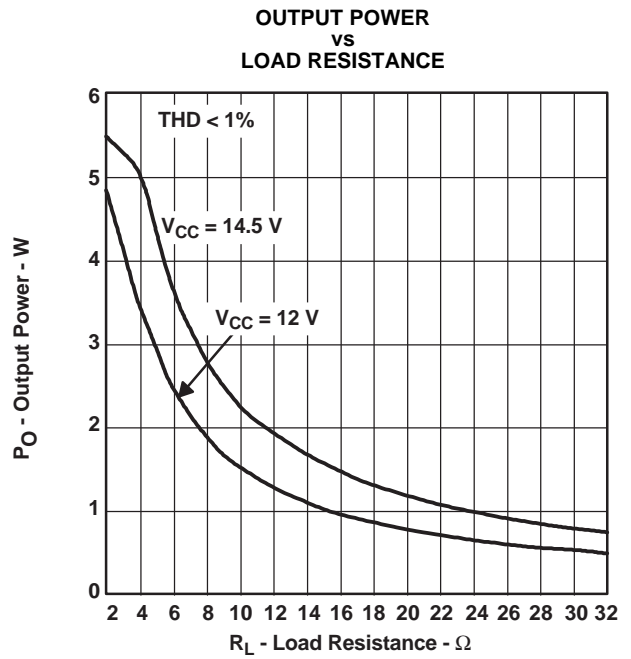

Figure 20.

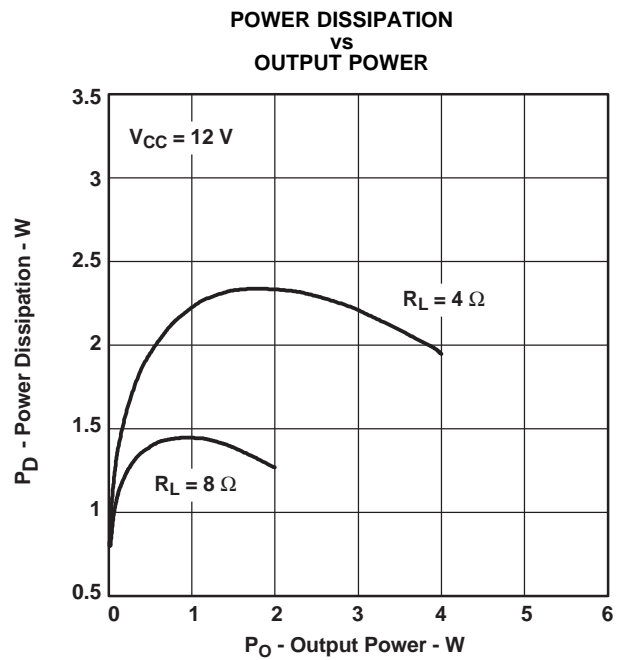

Figure 21.

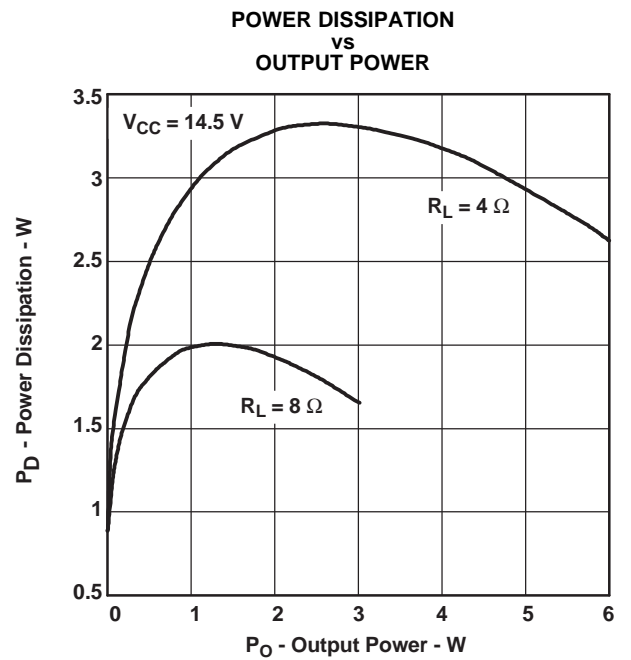
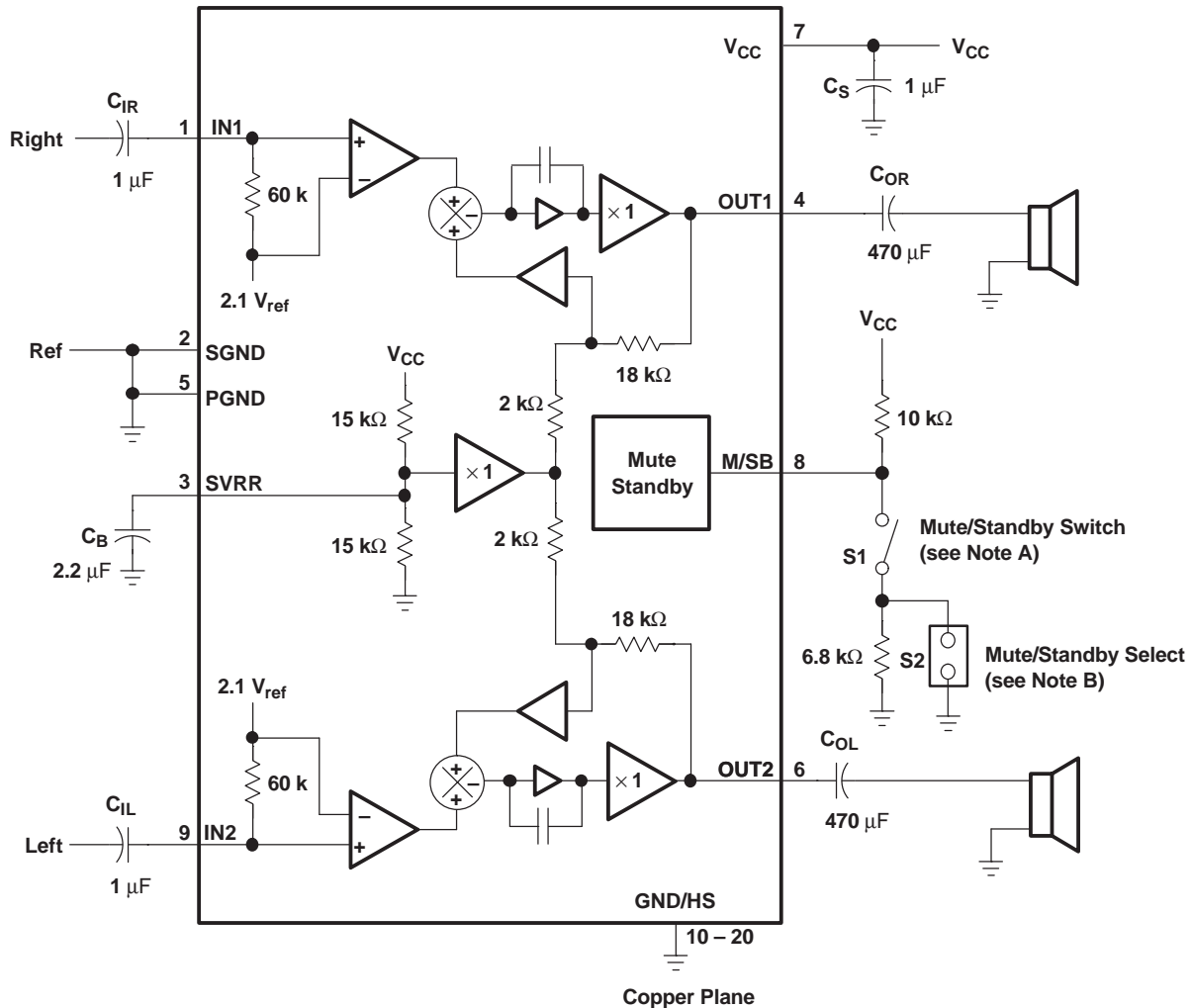

Figure 22.

## APPLICATION INFORMATION

### AMPLIFIER OPERATION

The TPA1517 is a stereo audio power amplifier designed to drive 4-Ω speakers at up to 6 W per channel. Figure 23 is a schematic diagram of the minimum recommended configuration of the amplifier. Gain is internally fixed at 20 dB (gain of 10 V/V).



- When S1 is open, the TPA1517 operates normally. When this switch is closed, the device is in mute/standby mode.
- When S2 is open, activating S1 places the TPA1517 in mute mode. When S2 is closed, activating S1 places the TPA1517 in standby mode.
- The terminal numbers are for the 20-pin NE package.

**Figure 23. TPA1517 Minimum Configuration**

The following equation is used to relate gain in V/V to dB:

$$G_{dB} = 20 \text{ LOG} \left( G_{V/V} \right)$$

**APPLICATION INFORMATION (continued)**

The audio outputs are biased to a midrail voltage which is shown by the following equation:

$$V_{MID} = \frac{V_{CC}}{2}$$

The audio inputs are always biased to 2.1 V when in mute or normal mode. Any dc offset between the input signal source and the input terminal is amplified and can seriously degrade the performance of the amplifier. For this reason, it is recommended that the inputs always be connected through a series capacitor (ac coupled). The power outputs, also having a dc bias, must be connected to the speakers via series capacitors.

**MUTE/STANDBY OPERATION**

The TPA1517 has three modes of operation; normal, mute, and standby. They are controlled by the voltage on the M/SB terminal as described in [Figure 24](#). In normal mode, the TPA1517 amplifies the signal applied to the two input terminals providing low impedance drive to speakers connected to the output terminals. In mute mode, the amplifier retains all bias voltages and quiescent supply current levels but does not pass the input signal to the output. In standby mode, the internal bias generators and power-drive stages are turned off, thereby reducing the supply current levels.

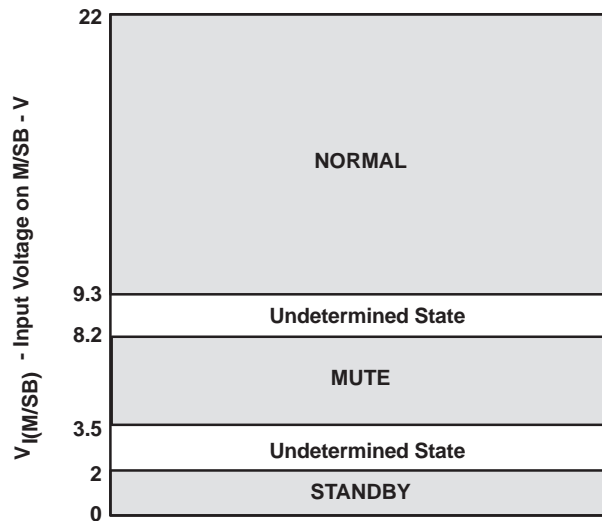
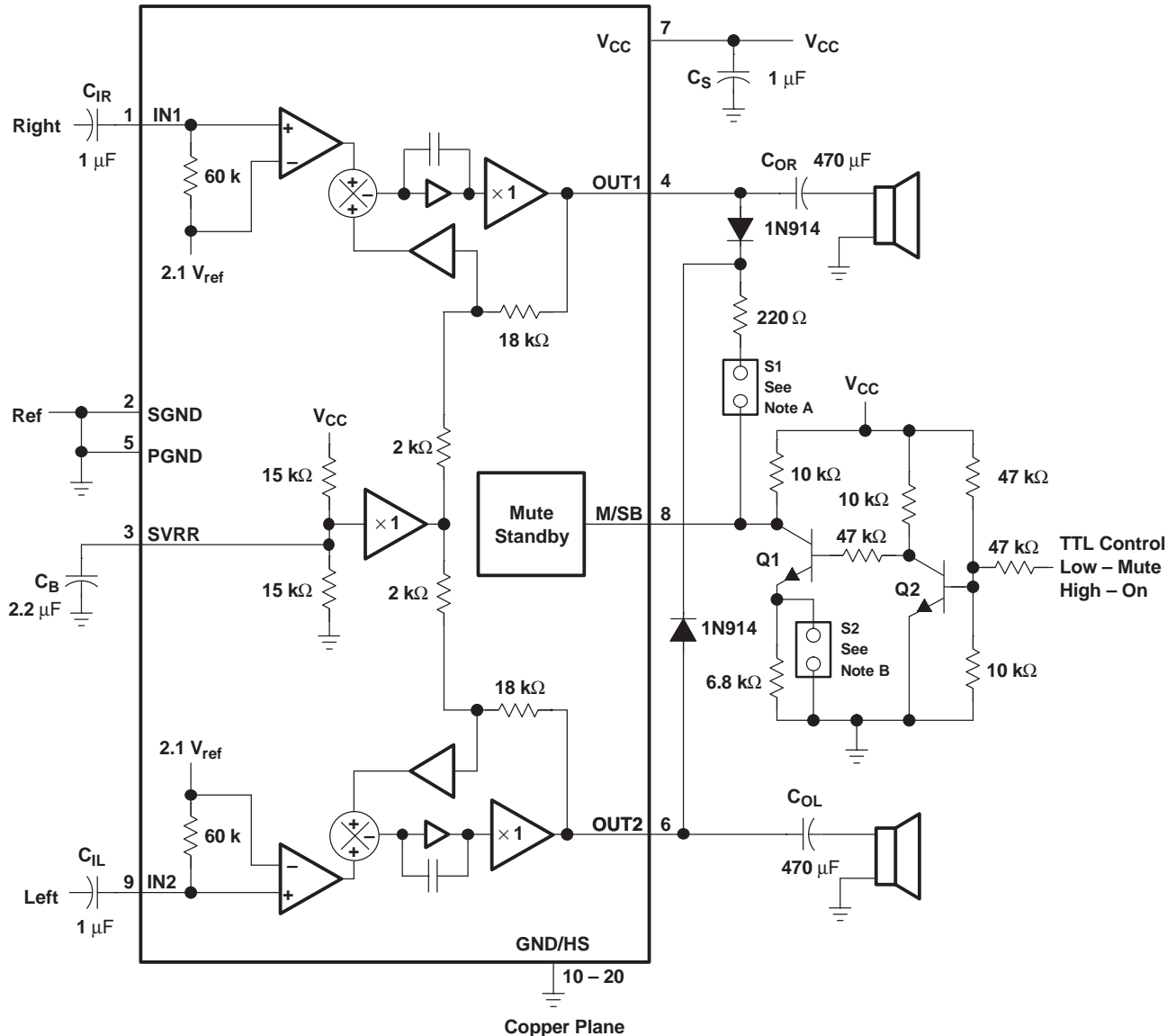

**Figure 24. Standby, Mute, and Normal (On) Operating Conditions**

The designer must take care to place the control voltages within the defined ranges for each desired mode, whenever an external circuit is used to control the input voltage at the M/SB terminal. The undefined area can cause unpredictable performance and should be avoided. As the control voltage moves through the undefined areas, pop or click sounds may be heard in the speaker. Moving from mute to normal causes a very small click sound. Whereas moving from standby to mute can cause a much larger pop sound. [Figure 25](#) shows external circuitry designed to help reduce transition pops when moving from standby mode to normal mode.

APPLICATION INFORMATION (continued)

Figure 25 is a reference schematic that provides TTL-level control of the M/SB terminal. A diode network is also included which helps reduce turn-on pop noises. The diodes serve to drain the charge out of the output coupling capacitors while the amplifier is in shutdown mode. When the M/SB voltage is in the normal operating range, the diodes have no effect on the ac performance of the system.



- A. When S1 is closed, the depop circuitry is active during standby mode.
- B. When S2 is open, activating S1 places the TPA1517 in mute mode. When S2 is closed, activating S1 places the TPA1517 in standby mode.
- C. The terminal numbers are for the 20-pin NE package.

Figure 25. TTL Control with POP Reduction

## APPLICATION INFORMATION (continued)

### COMPONENT SELECTION

Some of the general concerns for selection of capacitors are:

- Leakage currents on aluminum electrolytic capacitors
- ESR (equivalent series resistance)
- Temperature ratings

### LEAKAGE CURRENTS

Leakage currents on most ceramic, polystyrene, and paper capacitors are negligible for this application. Leakage currents for aluminum electrolytic and tantalum tend to be higher. This is especially important on the input terminals and the SVRR capacitor. These nodes encounter from 3 V to 7 V, and need to have leakage currents less than 1  $\mu$ A to keep from affecting the output power and noise performance.

### EQUIVALENT SERIES RESISTANCE

ESR is mainly important on the output coupling capacitor, where even 1 $\Omega$  of ESR in  $C_O$  with an 8- $\Omega$  speaker can reduce the output drive power by 12.5%. ESR should be considered across the frequency range of interest, (i.e., 20 Hz to 20 kHz). The following equation calculates the amount of power lost in the coupling capacitor:

$$\% \text{ Power in } C_O = \frac{\text{ESR}}{R_L}$$

The power supply decoupling requires a low ESR as well to take advantage of the full output drive current.

### TEMPERATURE RANGE

The temperature range of the capacitors are important. Many of the high-density capacitors perform differently at different temperatures. When consistent high performance is required from the system overtemperature in terms of low THD, maximum output power, and turn-on/off popping, then interactions of the coupling capacitors and the SVRR capacitors need to be considered, as well as the change in ESR on the output capacitor with temperature.

### TURN-ON POP CONSIDERATION

To select the proper input coupling capacitor, the designer should select a capacitor large enough to allow the lowest desired frequency pass and small enough that the time constant is shorter than the output RC time constant to minimize turn-on popping. The input time constant for the TPA1517 is determined by the input 60-k $\Omega$  resistance of the amplifier, and the input coupling capacitor according to the following generic equation:

$$T_C = \frac{1}{2\pi RC}$$

For example, 8- $\Omega$  speakers and 220- $\mu$ F output coupling capacitors would yield a 90-Hz cut-off point for the output RC network. The input network should be the same speed or faster ( $> 90$  Hz  $T_C$ ). A good choice would be 180 Hz. As the input resistance is 60 k $\Omega$ , a 14-nF input coupling capacitor would do.

The bypass-capacitor time constant should be much larger ( $\times 5$ ) than either the input coupling capacitor time constant or the output coupling capacitor time constants. In the previous example with the 220- $\mu$ F output coupling capacitor, the designer should want the bypass capacitor,  $T_C$ , to be in the order of 18 Hz or lower. To get an 18-Hz time constant,  $C_B$  is required to be 1  $\mu$ F or larger because the resistance this capacitor sees is 7.5 k $\Omega$ .

In summary, follow one of the three simple relations presented below, depending on the tradeoffs between low frequency response and turn-on pop.

1. If depop performance is the top priority, then follow:

$$7500 C_B > 5R_L C_O > 300000 C_I$$

2. If low frequency ac response is more important but depop is still a consideration then follow:

$$\frac{1}{2\pi 60000 C_I} < 10 \text{ Hz}$$

### APPLICATION INFORMATION (continued)

3. If low frequency response is most important and depop is not a consideration then follow:

$$\frac{1}{2\pi 60000 C_1} \leq \frac{1}{2\pi R_L C_1} \leq f_{low}$$

### THERMAL APPLICATIONS

Linear power amplifiers dissipate a significant amount of heat in the package under normal operating conditions. A typical music CD requires 12 dB to 15 dB of dynamic headroom to pass the loudest portions without distortion as compared with the average power output. [Figure 19](#) shows that when the TPA1517 is operating from a 12-V supply into a 4-Ω speaker that approximately 3.5 W peaks are possible. Converting watts to dB using the following equation:

$$\begin{aligned} P_{dB} &= 10\text{Log} \left( \frac{P_W}{P_{ref}} \right) \\ &= 10\text{Log} \left( \frac{3.5}{1} \right) \\ &= 5.44 \text{ dB} \end{aligned}$$

Subtracting dB for the headroom restriction to obtain the average listening level without distortion yields the following:

$$\begin{aligned} 5.44 \text{ dB} - 15 \text{ dB} &= -9.56 \text{ dB (15 dB headroom)} \\ 5.44 \text{ dB} - 12 \text{ dB} &= -6.56 \text{ dB (12 dB headroom)} \end{aligned}$$

Converting dB back into watts:

$$\begin{aligned} P_W &= 10^{P_{dB}/10} \times P_{ref} \\ &= 111 \text{ mW (15 dB headroom)} \\ &= 221 \text{ mW (12 dB headroom)} \end{aligned}$$

This is valuable information to consider when attempting to estimate the heat dissipation requirements for the amplifier system. Comparing the absolute worst cast, which is 3.5 W of continuous power output with 0 dB of headroom, against 12-dB and 15-dB applications drastically affects maximum ambient temperature ratings for the system. Using the power dissipation curves for a 12-V, 4-Ω system, internal dissipation in the TPA1517 and maximum ambient temperatures are shown in [Table 1](#).

**Table 1. TPA1517 Power Rating**

PEAK OUTPUT POWER (W)	AVERAGE OUTPUT POWER	POWER DISSIPATION (W/Channel)	MAXIMUM AMBIENT TEMPERATURE
3.5	3.5 W	2.1	-34°C
3.5	1.77 W (3 dB)	2.4	-61°C
3.5	884 mW (6 dB)	2.25	-48°C
3.5	442 mW (9 dB)	1.75	-4°C
3.5	221 mW (12 dB)	1.5	18°C
3.5	111 mW (15 dB)	1.25	40°C

The maximum ambient temperature depends on the heatsinking ability of the PCB system. The derating factor for the NE package with 7 square inches (17.78 cm) of copper area is 22.8 mW/°C. Converting this to  $\theta_{JA}$ :

$$\theta_{JA} = \frac{1}{\text{Derating}}$$

$$\begin{aligned} \text{For 0 CFM :} &= \frac{1}{0.0228} \\ &= 43.9^\circ\text{C/W} \end{aligned}$$

To calculate maximum ambient temperatures, first consider that the numbers from the dissipation graphs are per channel so the dissipated heat needs to be doubled for two channel operation. Given  $\theta_{JA}$ , the maximum allowable junction temperature and the total internal dissipation, the maximum ambient temperature can be calculated with the following equation. The maximum recommended junction temperature for the TPA1517 is 150°C.

$$\begin{aligned} T_{A \text{ Max}} &= T_{J \text{ Max}} - \theta_{JA} P_D \\ &= 150 - 43.9(1.25 \times 2) = 40^\circ\text{C (15 dB headroom, 0 CFM)} \end{aligned}$$

Table 1 clearly shows that for most applications some airflow is required to keep junction temperatures in the specified range. The TPA1517 is designed with thermal protection that turns the device off when the junction temperature surpasses 150°C to prevent damage to the IC. Using the DWP package on a multilayer PCB with internal ground planes can achieve better thermal performance. Table 1 was calculated for a maximum volume system; when the output level is reduced, the numbers in the table change significantly. Also using 8-Ω speakers dramatically increases the thermal performance by increasing amplifier efficiency.

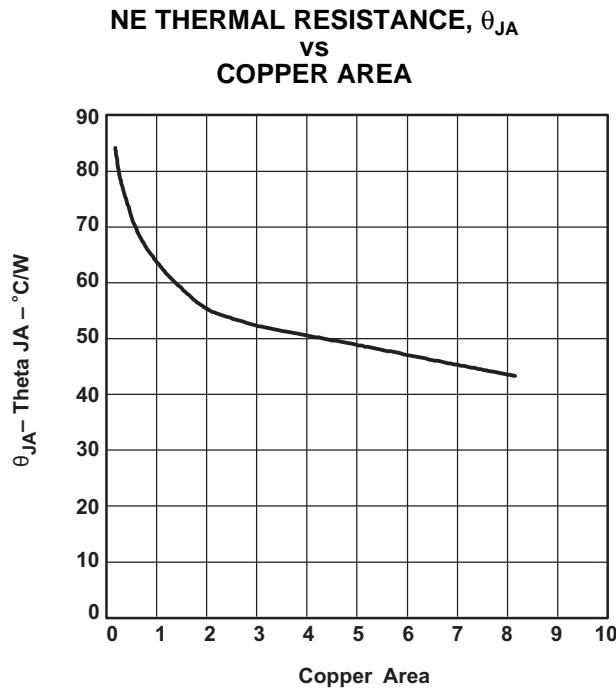

Figure 26.



**PACKAGING INFORMATION**

Orderable Device	Status (1)	Package Type	Package Drawing	Pins	Package Qty	Eco Plan (2)	Lead finish/ Ball material (6)	MSL Peak Temp (3)	Op Temp (°C)	Device Marking (4/5)	Samples
HPA00892DWPR	ACTIVE	SO PowerPAD	DWP	20	2000	TBD	Call TI	Call TI	-40 to 85		<a href="#">Samples</a>
TPA1517DWP	ACTIVE	SO PowerPAD	DWP	20	25	RoHS & Green	NIPDAU	Level-2-260C-1 YEAR	-40 to 85	TPA1517	<a href="#">Samples</a>
TPA1517DWPR	ACTIVE	SO PowerPAD	DWP	20	2000	RoHS & Green	NIPDAU	Level-2-260C-1 YEAR	-40 to 85	TPA1517	<a href="#">Samples</a>
TPA1517DWPRG4	ACTIVE	SO PowerPAD	DWP	20	2000	RoHS & Green	NIPDAU	Level-2-260C-1 YEAR	-40 to 85	TPA1517	<a href="#">Samples</a>
TPA1517NE	ACTIVE	PDIP	NE	20	20	RoHS & Non-Green	NIPDAU	N / A for Pkg Type	-40 to 85	TPA1517NE	<a href="#">Samples</a>

(1) The marketing status values are defined as follows:

**ACTIVE:** Product device recommended for new designs.

**LIFEBUY:** TI has announced that the device will be discontinued, and a lifetime-buy period is in effect.

**NRND:** Not recommended for new designs. Device is in production to support existing customers, but TI does not recommend using this part in a new design.

**PREVIEW:** Device has been announced but is not in production. Samples may or may not be available.

**OBSELETE:** TI has discontinued the production of the device.

(2) **RoHS:** TI defines "RoHS" to mean semiconductor products that are compliant with the current EU RoHS requirements for all 10 RoHS substances, including the requirement that RoHS substance do not exceed 0.1% by weight in homogeneous materials. Where designed to be soldered at high temperatures, "RoHS" products are suitable for use in specified lead-free processes. TI may reference these types of products as "Pb-Free".

**RoHS Exempt:** TI defines "RoHS Exempt" to mean products that contain lead but are compliant with EU RoHS pursuant to a specific EU RoHS exemption.

**Green:** TI defines "Green" to mean the content of Chlorine (Cl) and Bromine (Br) based flame retardants meet JS709B low halogen requirements of <=1000ppm threshold. Antimony trioxide based flame retardants must also meet the <=1000ppm threshold requirement.

(3) MSL, Peak Temp. - The Moisture Sensitivity Level rating according to the JEDEC industry standard classifications, and peak solder temperature.

(4) There may be additional marking, which relates to the logo, the lot trace code information, or the environmental category on the device.

(5) Multiple Device Markings will be inside parentheses. Only one Device Marking contained in parentheses and separated by a "~" will appear on a device. If a line is indented then it is a continuation of the previous line and the two combined represent the entire Device Marking for that device.

(6) Lead finish/Ball material - Orderable Devices may have multiple material finish options. Finish options are separated by a vertical ruled line. Lead finish/Ball material values may wrap to two lines if the finish value exceeds the maximum column width.

**Important Information and Disclaimer:** The information provided on this page represents TI's knowledge and belief as of the date that it is provided. TI bases its knowledge and belief on information provided by third parties, and makes no representation or warranty as to the accuracy of such information. Efforts are underway to better integrate information from third parties. TI has taken and continues to take reasonable steps to provide representative and accurate information but may not have conducted destructive testing or chemical analysis on incoming materials and chemicals. TI and TI suppliers consider certain information to be proprietary, and thus CAS numbers and other limited information may not be available for release.

In no event shall TI's liability arising out of such information exceed the total purchase price of the TI part(s) at issue in this document sold by TI to Customer on an annual basis.

**TAPE AND REEL INFORMATION**

**QUADRANT ASSIGNMENTS FOR PIN 1 ORIENTATION IN TAPE**



\*All dimensions are nominal

Device	Package Type	Package Drawing	Pins	SPQ	Reel Diameter (mm)	Reel Width W1 (mm)	A0 (mm)	B0 (mm)	K0 (mm)	P1 (mm)	W (mm)	Pin1 Quadrant
TPA1517DWPR	SO Power PAD	DWP	20	2000	330.0	24.4	10.8	13.3	2.7	12.0	24.0	Q1

**TAPE AND REEL BOX DIMENSIONS**

\*All dimensions are nominal

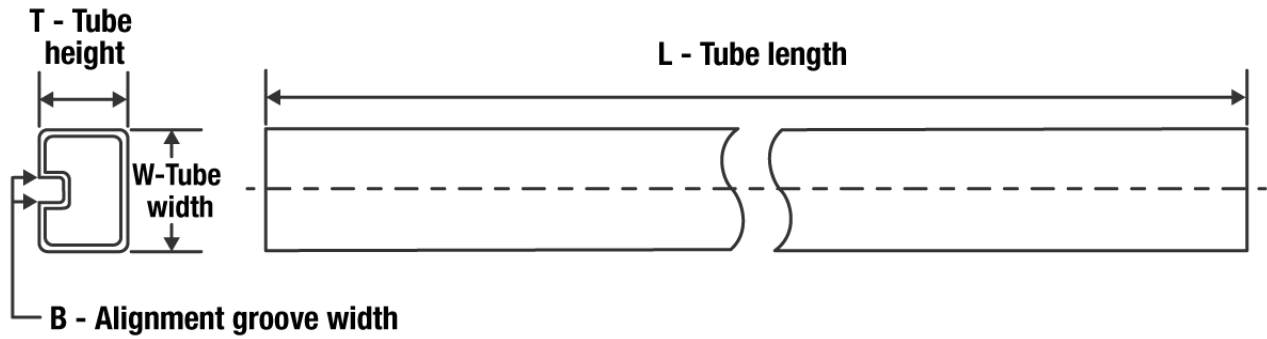
Device	Package Type	Package Drawing	Pins	SPQ	Length (mm)	Width (mm)	Height (mm)
TPA1517DWPR	SO PowerPAD	DWP	20	2000	350.0	350.0	43.0

**TUBE**

\*All dimensions are nominal

Device	Package Name	Package Type	Pins	SPQ	L (mm)	W (mm)	T (μm)	B (mm)
TPA1517DWP	DWP	HSOIC	20	25	506.98	12.7	4826	6.6
TPA1517NE	NE	PDIP	20	20	506	13.97	11230	4.32

DWP (R-PDSO-G\*\*) 20 PINS SHOWN

PowerPAD™ PLASTIC SMALL-OUTLINE PACKAGE

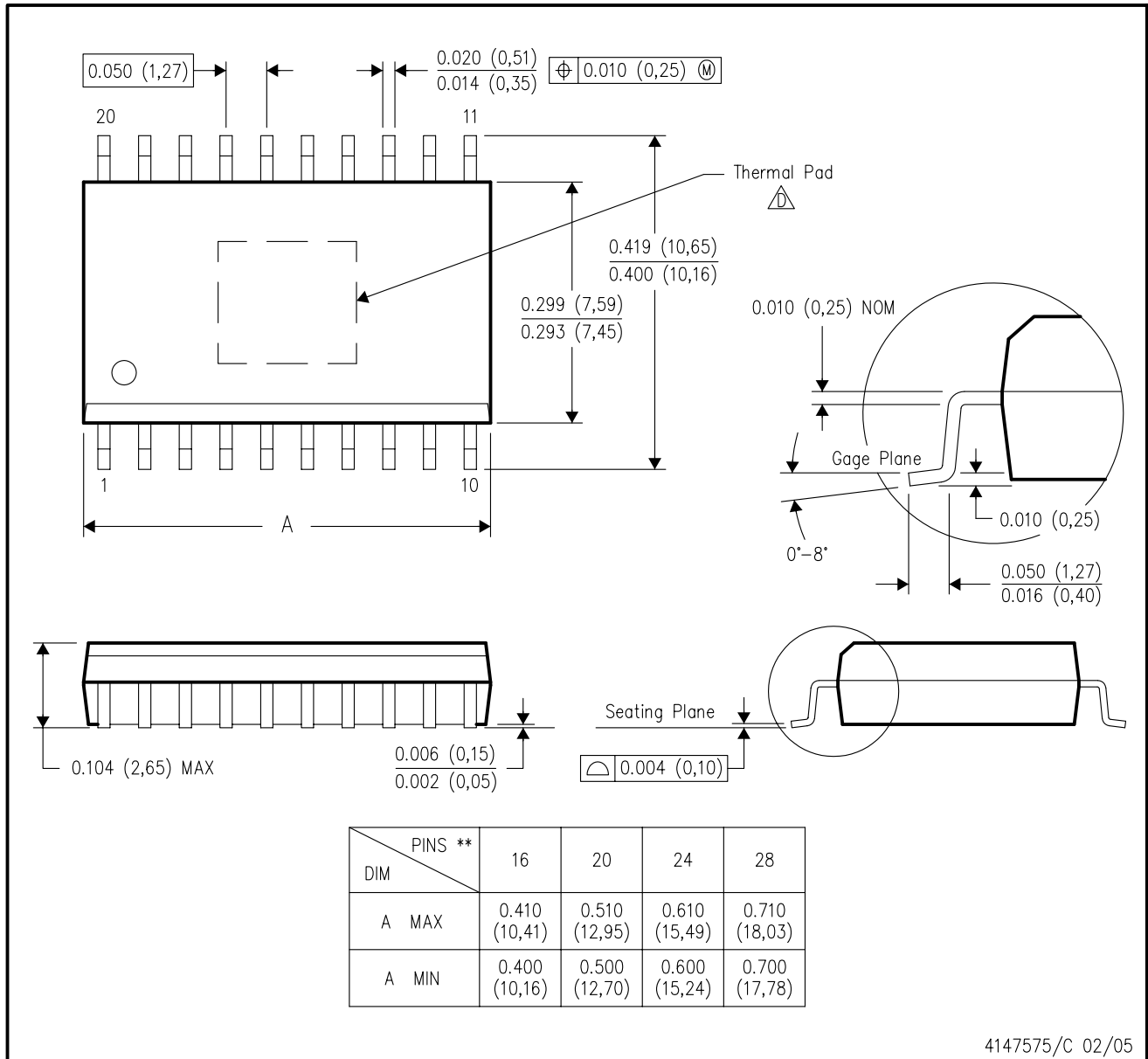

- NOTES:
- A. All linear dimensions are in inches (millimeters).
  - B. This drawing is subject to change without notice.
  - C. Body dimensions do not include mold flash or protrusion not to exceed 0.006 (0,15).
- This package is designed to be soldered to a thermal pad on the board. Refer to Technical Brief, PowerPad Thermally Enhanced Package, Texas Instruments Literature No. SLMA002 for information regarding recommended board layout. This document is available at [www.ti.com](http://www.ti.com) <<http://www.ti.com>>. See the product data sheet for details regarding the exposed thermal pad dimensions.

PowerPAD is a trademark of Texas Instruments.

## THERMAL PAD MECHANICAL DATA

DWP (R-PDSO-G20)

PowerPAD™ PLASTIC SMALL OUTLINE

### THERMAL INFORMATION

This PowerPAD™ package incorporates an exposed thermal pad that is designed to be attached to a printed circuit board (PCB). The thermal pad must be soldered directly to the PCB. After soldering, the PCB can be used as a heatsink. In addition, through the use of thermal vias, the thermal pad can be attached directly to the appropriate copper plane shown in the electrical schematic for the device, or alternatively, can be attached to a special heatsink structure designed into the PCB. This design optimizes the heat transfer from the integrated circuit (IC).

For additional information on the PowerPAD package and how to take advantage of its heat dissipating abilities, refer to Technical Brief, PowerPAD Thermally Enhanced Package, Texas Instruments Literature No. SLMA002 and Application Brief, PowerPAD Made Easy, Texas Instruments Literature No. SLMA004. Both documents are available at [www.ti.com](http://www.ti.com).

The exposed thermal pad dimensions for this package are shown in the following illustration.

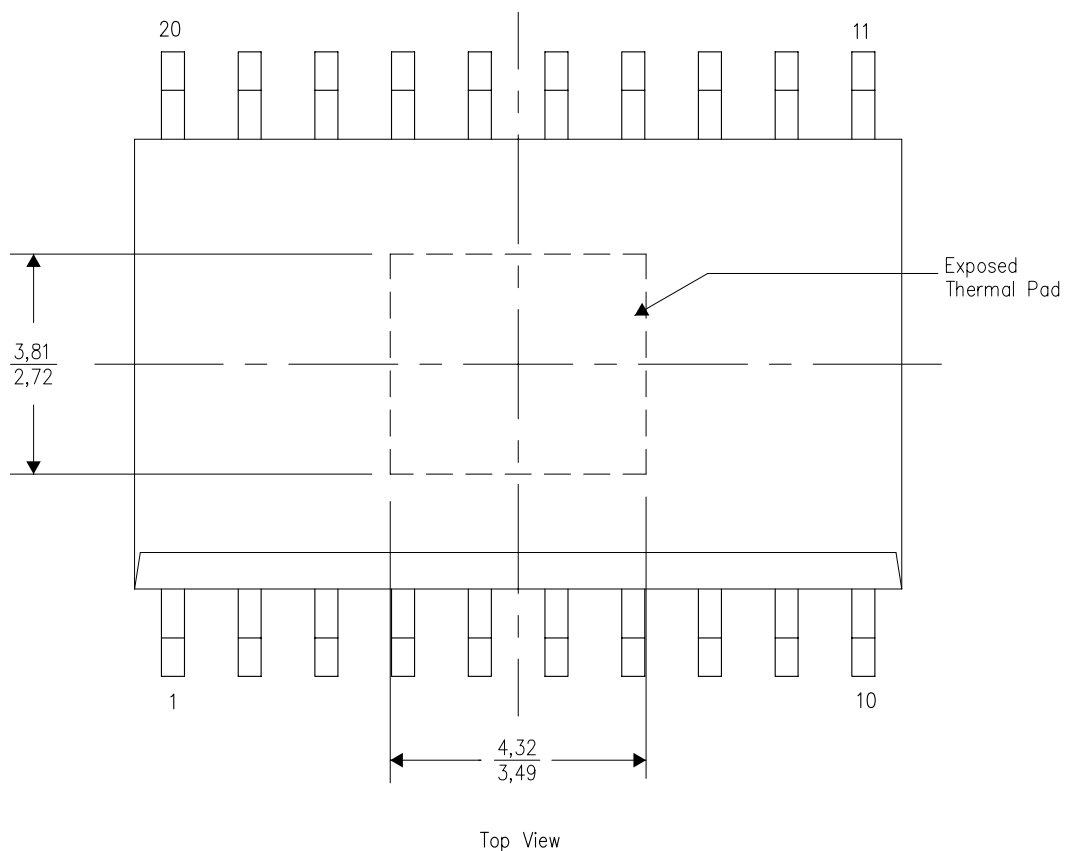

4206325-2/E 12/10

NOTE: A. All linear dimensions are in millimeters

## IMPORTANT NOTICE AND DISCLAIMER

TI PROVIDES TECHNICAL AND RELIABILITY DATA (INCLUDING DATA SHEETS), DESIGN RESOURCES (INCLUDING REFERENCE DESIGNS), APPLICATION OR OTHER DESIGN ADVICE, WEB TOOLS, SAFETY INFORMATION, AND OTHER RESOURCES "AS IS" AND WITH ALL FAULTS, AND DISCLAIMS ALL WARRANTIES, EXPRESS AND IMPLIED, INCLUDING WITHOUT LIMITATION ANY IMPLIED WARRANTIES OF MERCHANTABILITY, FITNESS FOR A PARTICULAR PURPOSE OR NON-INFRINGEMENT OF THIRD PARTY INTELLECTUAL PROPERTY RIGHTS.

These resources are intended for skilled developers designing with TI products. You are solely responsible for (1) selecting the appropriate TI products for your application, (2) designing, validating and testing your application, and (3) ensuring your application meets applicable standards, and any other safety, security, regulatory or other requirements.

These resources are subject to change without notice. TI grants you permission to use these resources only for development of an application that uses the TI products described in the resource. Other reproduction and display of these resources is prohibited. No license is granted to any other TI intellectual property right or to any third party intellectual property right. TI disclaims responsibility for, and you will fully indemnify TI and its representatives against, any claims, damages, costs, losses, and liabilities arising out of your use of these resources.

TI's products are provided subject to [TI's Terms of Sale](#) or other applicable terms available either on [ti.com](http://ti.com) or provided in conjunction with such TI products. TI's provision of these resources does not expand or otherwise alter TI's applicable warranties or warranty disclaimers for TI products.

TI objects to and rejects any additional or different terms you may have proposed.

Mailing Address: Texas Instruments, Post Office Box 655303, Dallas, Texas 75265  
Copyright © 2022, Texas Instruments Incorporated