

FEATURES

- Unconditional Stability
- RF Ports Matched to 50 Ohms
- Internal DC Voltage Regulation
- Reverse Polarity Protection
- RoHS Compliant
- Hermetically Sealed Kovar Package

TYPICAL APPLICATIONS

- Wireless Infrastructure
- RF Microwave and VSAT
- Military and Aerospace
- Test Instruments
- Fiber Optics

ELECTRICAL SPECIFICATIONS (@ 23°C)

| Parameter | Min | Max | Typ | Units |
|---|-----|------|-----|-------|
| Frequency Range | 2.0 | 40.0 | - | GHz |
| Noise Figure | - | 7.0 | 4.6 | dB |
| Gain (S21) | 30 | - | 34 | dB |
| Gain Flatness | - | 3.0 | 2.4 | ± dB |
| Output Power @ 1dB Compression Point (P1dB) | +15 | - | +18 | dBm |
| Input VSWR (S11) | - | 2.7 | 2.3 | - |
| Output VSWR (S22) | - | 2.7 | 2.0 | - |
| DC Supply Voltage | +12 | +18 | +15 | VDC |
| DC Supply Current | - | 450 | 320 | mA |

Absolute Maximum Ratings

| Parameter | Rating |
|---------------------------|-------------------------|
| DC Supply Voltage | +20 V |
| RF Input Power | +13 dBm |
| Operating Temperature | -55°C to +85°C |
| Non-Operating Temperature | -65°C to +125°C |
| RF Port Coupling (In/Out) | DC Coupled / AC Coupled |

Mechanical Specifications

| Parameter | Value |
|---------------------|-------------------|
| Length | 0.94 in [23.8 mm] |
| Width | 0.74 in [18.7 mm] |
| Height | 0.70 in [17.8 mm] |
| Connectors (In/Out) | K(F) / K(F) |
| Approx. Weight | 13.8 g |

The information above is relative to the sale of a COTS product as depicted. For information regarding other amplifier features not listed for this specific LNA model, please review our product overview brochure at the following link or contact your local representative.
[LNA Series Brochure](#)

The material presented in this datasheet was current at the time of publication. Narda-MITEQ's continuing product improvement program makes it necessary to reserve the right to change our mechanical and electrical specifications without notice. If either of these parameters is critical, please contact the factory to verify that the information is current.

This material consists of Narda-MITEQ general capabilities information and does not contain controlled technical data as defined within the International Traffic in Arms (ITAR) Part 120.10 or Export Administration Regulations (EAR) Part 734.7-11. D-405/05.01.18

Typical Performance @ 23°C (Reference S/N 2149694)

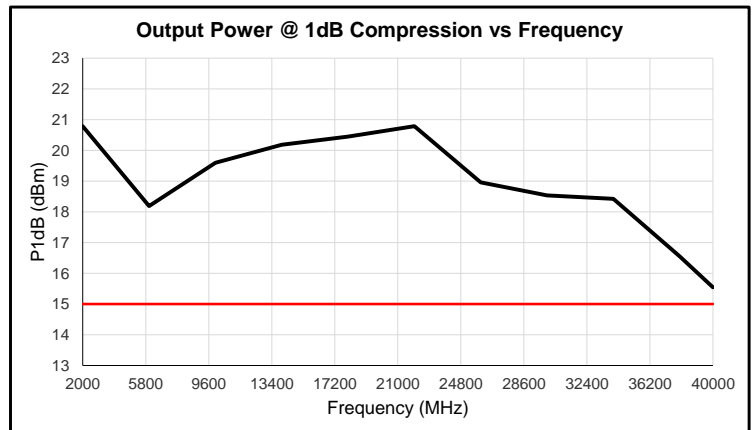
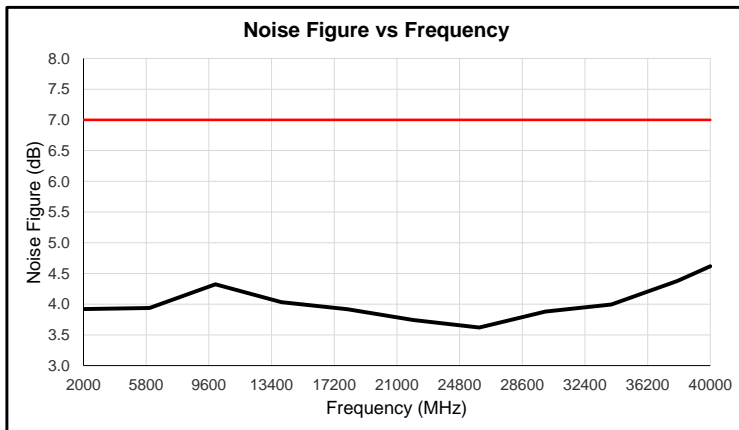
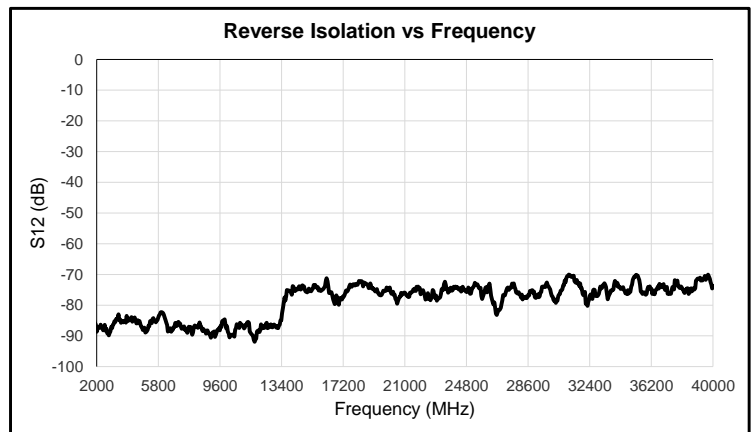
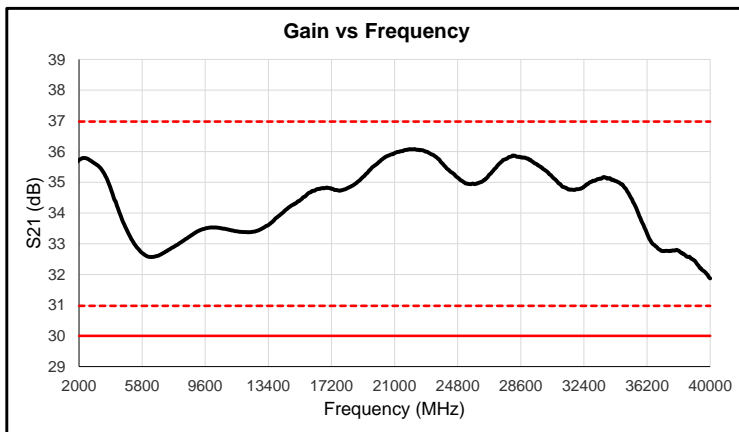
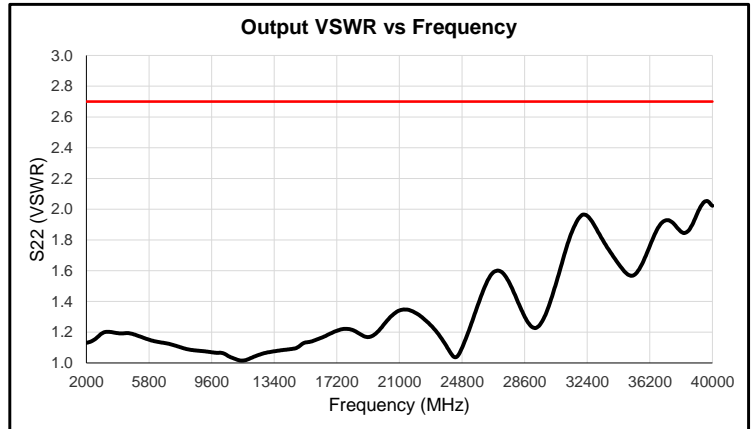
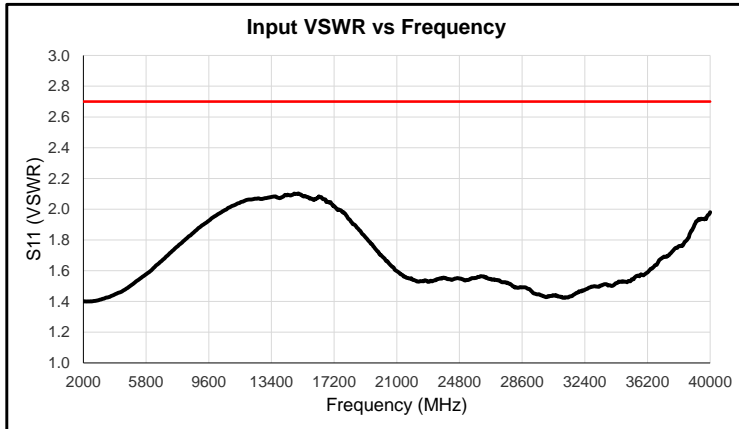

S2P file may be available upon request

| Environmental Specifications | | |
|------------------------------|-------------------------------------|------------------------|
| Parameter | Standard | Description |
| Operational Temperature | | -55°C to +85°C |
| Storage Temperature | | -65°C to +125°C |
| Random Vibration | MIL-STD-883K, Method 2026, Cond. 1B | 50 - 2000 Hz, 7.3 Grms |
| Humidity | MIL-STD-202, Method 103B, Cond. B | 95% RH Non-Condensing |
| Altitude | MIL-STD-883K, Method 1001, Cond. C | 50,000 ft |

This amplifier is designed to meet the above conditions. If ESS testing is required please contact factory.

Outline (Reference Drawing 135997)

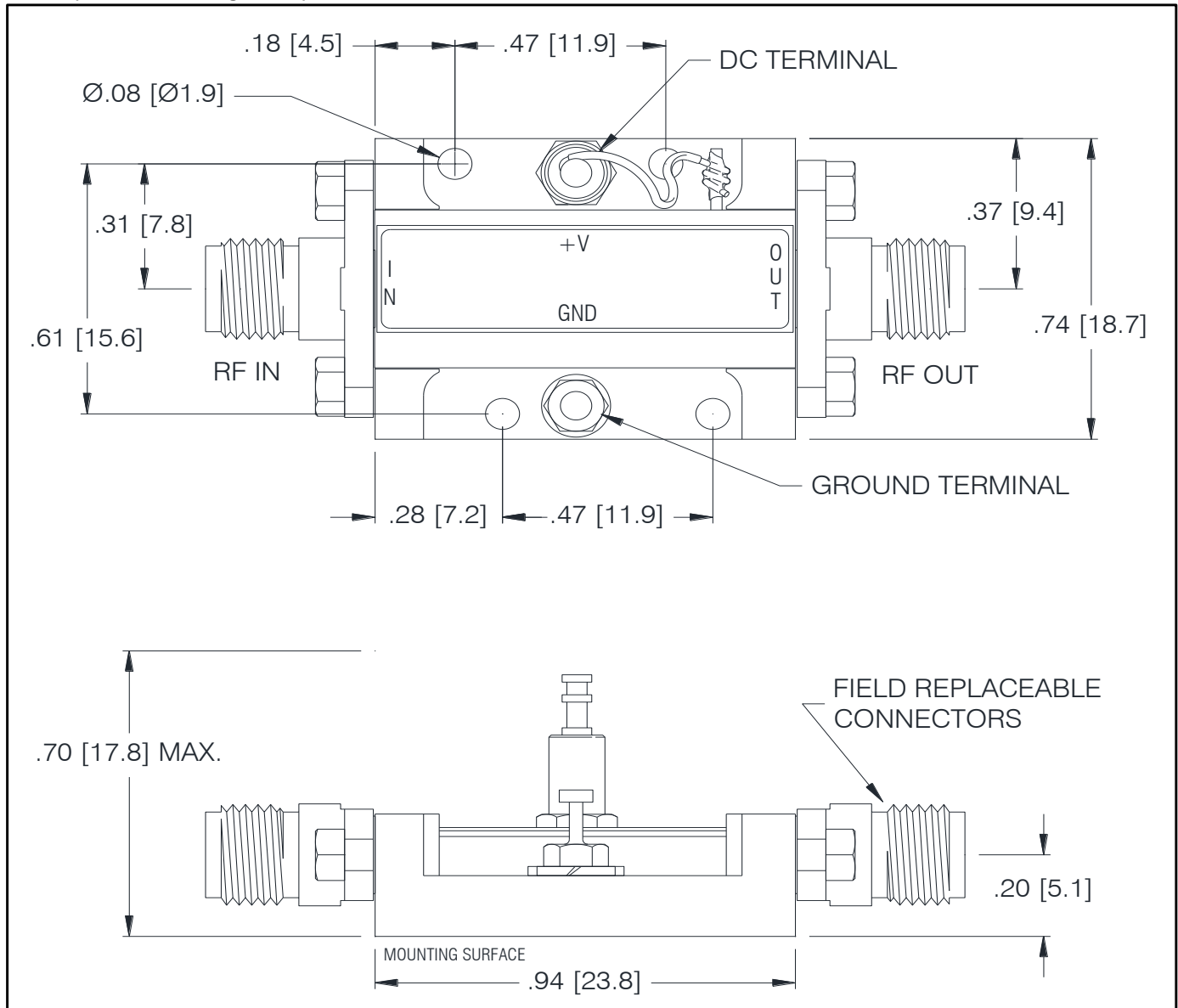

STEP file may be available upon request