

JTI – HEAT SINKS FOR POWER LEDs

882 SERIES – RADIAL FIN HEAT SINK FOR “STAR” LED PACKAGES



Wakefield's new 882 series heat sinks can be used with LEDs in the star package from Lumileds, Osram, and others. The radial design and fin area is ideally suited for natural convection applications such as ceiling lighting. A fan can also be used for increased performance in a forced convection application. Three sets of mounting holes allow maximum flexibility.

- The six .090 holes accommodate the LED module with # 4-40 screws,
- The six .153 holes can accommodate a multi-LED circuit board, mount to a panel with # 10-32 screws, or act as a conduit for wires
- The four .201 holes can be used to mount the heat sink to a panel with # 1/4-20 screws

Standard P/N	Height "A" in (mm)	Natural Convection Temp rise over ambient	Forced Convection Thermal resistance @200LFM	Weight lbs (grams)
882-50AB	0.50 (12.7)	60 °C @ 9 W	4.33 °C/W	0.073 (34)
882-100AB	1.00 (25.4)	48 °C @ 9 W	2.88 °C/W	0.146 (67)
882-200AB	2.00 (50.8)	36 °C @ 9 W	1.89 °C/W	0.293 (133)
882-300AB	3.00 (76.2)	28 °C @ 9 W	1.55 °C/W	0.439 (199)

MECHANICAL DIMENSIONS

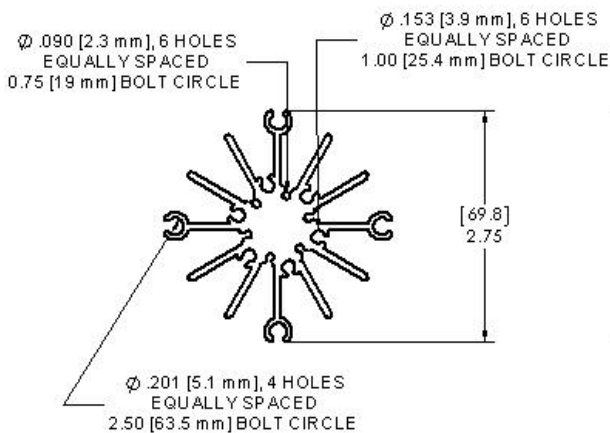

NATURAL AND FORCED CONVECTION CHARACTERISTICS

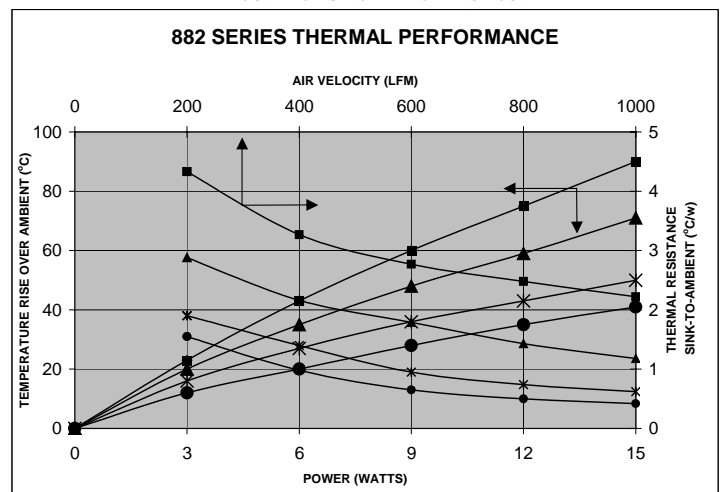

Wakefield Thermal Solutions believes that information provided is accurate as of publication date. Product testing in customer applications is recommended. The physical properties reported are representative of performance values obtained by standard predictive and testing methods. Wakefield Thermal Solutions is a manufacturer of heat dissipation products and reserves the right to make changes to its products without notice to improve the design or performance characteristics.