



## 15DMWE4\_1.5 series

15W - Single Output - Wide Input - Isolated & Regulated  
1" x 1" DC-DC Converter

## DC-DC Converter 15 Watt

- ⊕ Wide 4:1 input voltage range
- ⊕ High efficiency up to 91%
- ⊕ Short circuit protection (SCP)
- ⊕ Isolation voltage: 1.5kVDC
- ⊕ Over-current, over-voltage, under-voltage protection
- ⊕ RoHS compliant
- ⊕ Operating temperature range: -40°C to +105°C
- ⊕ Meets CISPR32/EN55032 CLASS A, no external components
- ⊕ International standard pin-out
- ⊕ Wiring and rail mounting products featuring anti-reverse connection for input
- ⊕ EN62368, UL62368 approved

The 15DMWE4\_1.5 series are isolated 15W DC/DC converters with 2:1 input voltage. They feature efficiency up to 91%, 1500VDC isolation, operating temperature of -40°C to +105°C, input under-voltage protection, output over-voltage, output over-current, output short circuit protection and EMI meets CISPR32/EN55032 CLASS A.

They are widely applied in industrial control, electric power, instruments and communication fields. Extension packages with wiring mounting and rail mounting also enable them with reverse voltage protection.



Common specifications	
Short circuit protection:	Hiccup, continuous, self-recovery
Cooling:	Free air convection
Operation temperature range:	• 3.3V/5V output: 40°C~+95°C • others: -40°C~+105°C
Storage temperature range:	-55°C~+125°C
Storage humidity range:	95% MAX
Lead temperature:	300°C MAX, 1.5mm from case for 10 sec
Vibration:	10-150Hz, 5G, 0.75mm. along X, Y and Z
Case material:	Aluminium alloy
MTBF (MIL-HDBK-217F @25°C):	1,000,000 hours
Weight:	15g / 35g (wiring) / 55g (rail) with heatsink: 20g / 40g (wiring) / 60g (rail)

Input specifications						
Item	Test condition	Min	Typ	Max	Units	
Input current (full load/no load)	24VDC					
	• 3.3V output		625/30	640/50		mA
Nominal input series, nominal input voltage	• 5V output		694/30	710/50		mA
	• 12V output		694/6	710/15		mA
	• 15V output		687/6	703/15		mA
	• 24V output		687/10	703/20		mA
Reflected ripple current	48VDC					
	• 3.3V output		313/15	320/30		mA
	• 5V output		348/15	356/30		mA
	• 12V output		344/3	352/11		mA
	• 15V output		344/3	352/11		mA
• 24V output		344/4	352/11		mA	
Surge voltage (1sec. max)	Nominal input series		30			mA
Starting voltage*	• 24VDC input			9		VDC
	• 48VDC input			18		VDC
Input under-voltage protection	• 24VDC input	-0.7				VDC
	• 48VDC input	-0.7		50		VDC
Starting time*	• 24VDC input					ms
	• 48VDC input					ms
Input filter	Pi Type					
Hot plug	Unavailable					
Switching frequency (PWM mode)	• 3.3V/5V output		300			KHz
	• others		270			KHz
Ctrl (The voltage of Ctrl pin is relative to input pin GND)	• Module switch on					
	• Module switch off					
	• Input current when switched off		2	7		mA

\* Nominal input voltage & constant resistance load

Isolation specifications						
Item	Test condition	Min	Typ	Max	Units	
Isolation voltage*	Input/output	1500				VDC
Isolation voltage*	Input/output case	1000				VDC
Isolation resistance	Test at 500VDC	1000				MΩ
Isolation capacitance			2000			pF

\* with the test time of 1 minute and the leak current lower than 1mA

Output specifications						
Item	Test condition	Min	Typ	Max	Units	
Voltage accuracy			±1	±3		%
Line regulation	Full load, Vmin-Vmax		±0.2	±0.5		%
Load regulation	5% load to full load		±0.5	±1		%
Transient recovery time	25% load step change		300	500		μs
Transient response deviation	25% load step change • 3.3V/5V output • Others		±3	±7		%
			±3	±5		%
Temperature drift	Full load			±0.03		%/°C
Ripple and noise*	20MHz Bandwidth		50	100		mVp-p
Trim	Input voltage range	90		110		%Vo
Over voltage protection	Input voltage range	110		160		%Vo
Over current protection	Input voltage range	110	150	190		%Io

\* 0%-5% load ripple&noise is no more than 5%Vo.  
Ripple and noise are measured by "parallel cable" method.

**Example:**  
**15DMWE4\_2415S1.5**  
15 = 15Watt; D = DIP; M = series; W4 = wide input (4:1); E = cost effective; 9-36Vin; 15Vout; S = single output; 1.5 = 1500VDC isolation

## 15DMWE4\_1.5 series

15W - Single Output - Wide Input - Isolated & Regulated  
1" x 1" DC-DC Converter

EMC specifications				
EMI	CE	CISPR32/EN55032	CLASS A (without external components)/ CLASS B (see EMC solution recommended circuit, ②)	
EMI	RE	CISPR32/EN55032	CLASS A (without external components)/ CLASS B (see EMC solution recommended circuit, ②)	
EMS	ESD	IEC/EN61000-4-2	Contact ±6KV, Air ±8KV	perf. Criteria B
EMS	RS	IEC/EN61000-4-3	10V/m	perf. Criteria A
EMS	EFT	IEC/EN61000-4-4	±2KV (see EMC solution recommended circuit, ③)	perf. Criteria A
EMS	Surge	IEC/EN61000-4-5	line to line ±2KV (see EMC solution recommended circuit, ③)	perf. Criteria B
EMS	CS	IEC/EN61000-4-6	3 Vr.m.s	perf. Criteria A

Part Number	Input Voltage [VDC]			Output Voltage [VDC]	Output Current [mA] Full load	Efficiency [%, Typ.]***	Capacitive load [µF, Max.]
	Nominal	Range*	Max**				
15DMWE4_2403S1.5	24	9-36	40	3.3	4000	88	4700
15DMWE4_2405S1.5	24	9-36	40	5	3000	90	4700
15DMWE4_2412S1.5	24	9-36	40	12	1250	90	1000
15DMWE4_2415S1.5	24	9-36	40	15	1000	91	820
15DMWE4_2424S1.5	24	9-36	40	24	625	91	270
15DMWE4_4803S1.5	48	18-75	80	3.3	4000	88	4700
15DMWE4_4805S1.5	48	18-75	80	5	3000	90	4700
15DMWE4_4812S1.5	48	18-75	80	12	1250	91	1000
15DMWE4_4815S1.5	48	18-75	80	15	1000	91	820
15DMWE4_4824S1.5	48	18-75	80	24	625	91	270

Add suffix H for heatsink, f.ex. 15DMWE4\_1203S1.5H, suffix CM for chassis mounting, f.ex. 15DMWE4\_1203S1.5CM, or suffix RM for rail mounting, f.ex. 15DMWE4\_1203S1.5RM. If the application has a higher requirement for heat dissipation, you can choose modules with heat sink.

\* The minimum input voltage and starting voltage of wiring or rail models are 1VDC higher than those of DIP package due to input reverse polarity protection function.

\*\* Absolute maximum rating without damage on the converter, but it isn't recommended.

\*\*\* Efficiency is measured in nominal input voltage and rated output load; for wiring and rail mounting models, due to input reverse polarity protection, a minimum efficiency greater than Min.-2 is qualified.

## Typical characteristics

Nominal input voltage, 12V, 15V, 24V output

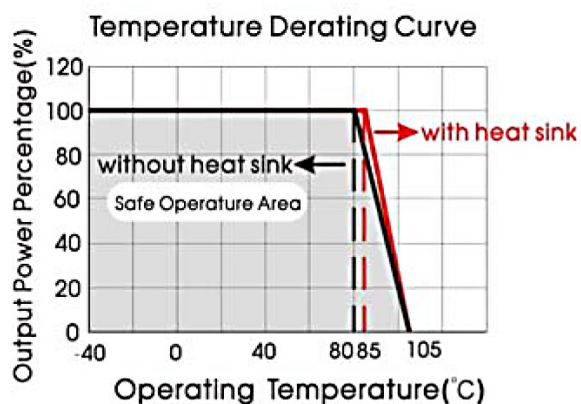

Nominal input voltage, 3.3V, 5V output

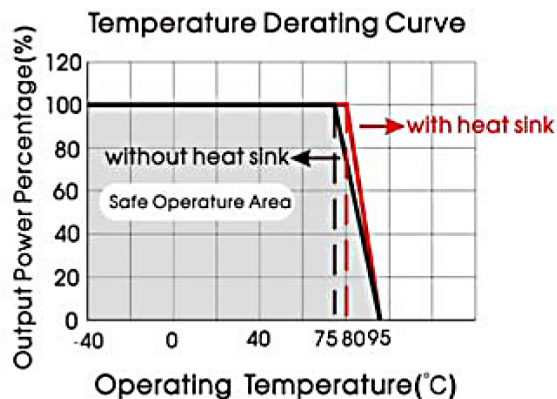

## 15DMWE4\_1.5 series

15W - Single Output - Wide Input - Isolated & Regulated  
1" x 1" DC-DC Converter

### Efficiency

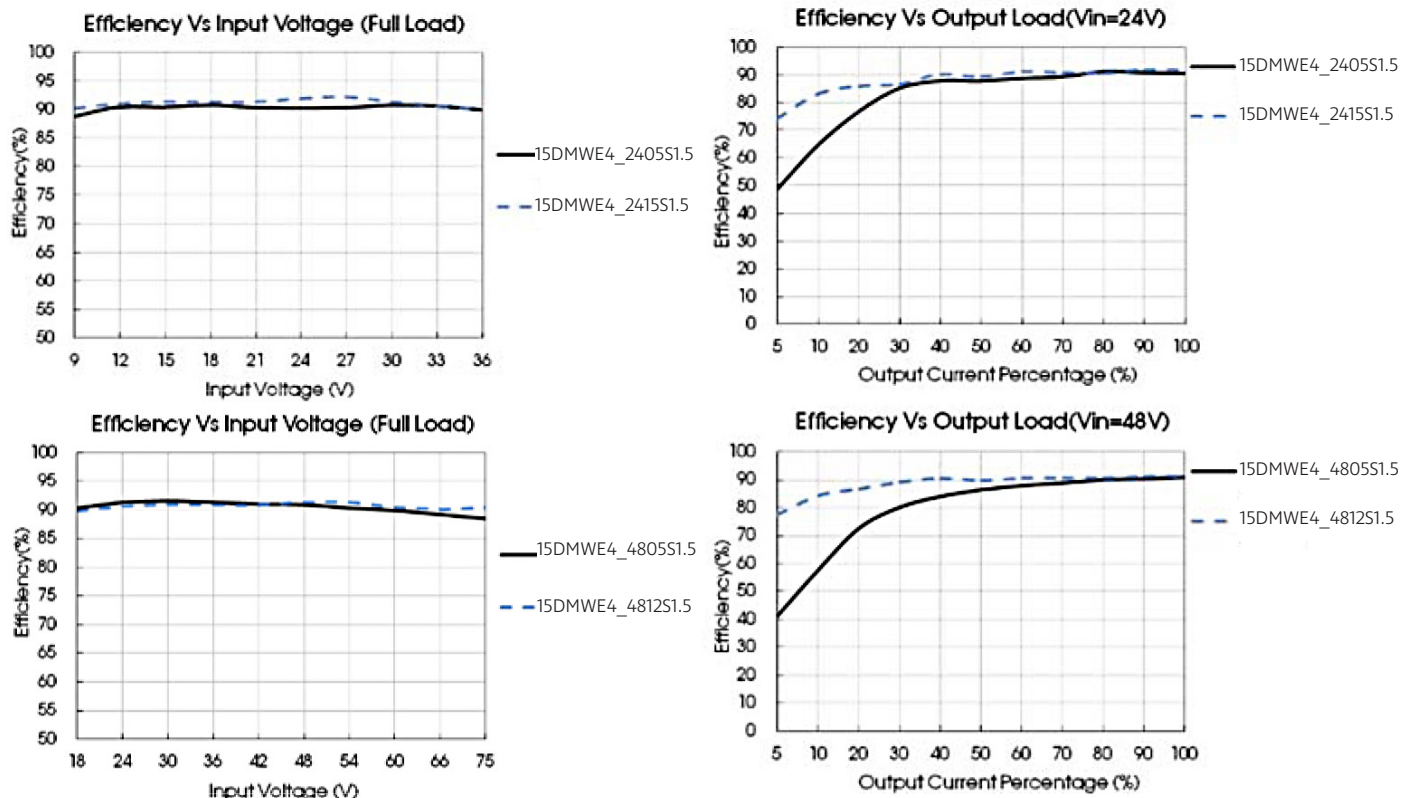

### Typical application

All the DC/DC converters of this series are tested according to the recommended circuit before delivery.

If it is required to further reduce input and output ripple, properly increase the input & output of additional capacitors  $C_{in}$  and  $C_{out}$  or select capacitors of low equivalent impedance provided that the capacitance is no larger than the max. capacitive load of the product.



Vout (VDC)	Cin (μF)	Cout (μF)
3.3/5/12/15	100	100
24		47

### EMC solution-recommended circuit

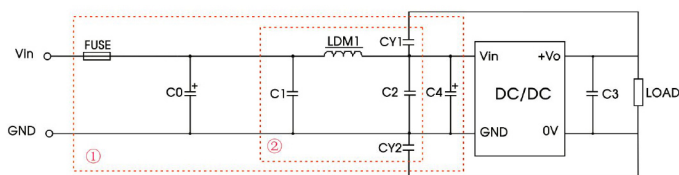

Notes: Part ① is used for EMC test and part ② for EMI filtering; selected based on needs.

Parameter description:

Model	Vin:24V	Vin:48V
FUSE	Choose according to actual input current	
C0, C4	330μF/50V	330μF/100V
C1, C2	4.7μF/50V	4.7μF/100V
C3	Refer to the Cout in typical application	
LDM1	2.2μH/4A	2.2μH/2A
CY1/CY2	1nF/2KV	

## 15DMWE4\_1.5 series

15W - Single Output - Wide Input - Isolated & Regulated  
1" x 1" DC-DC Converter

### Application of trim and calculation of trim resistance

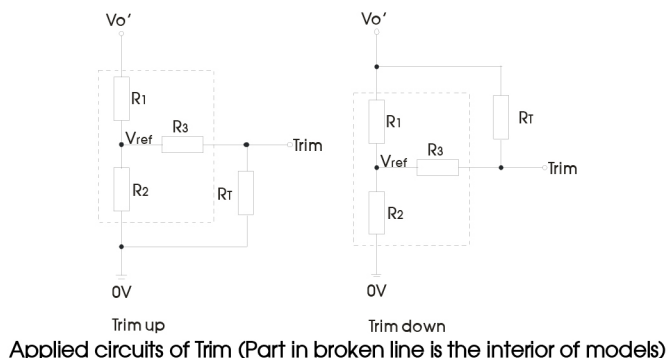

Calculation formula of Trim resistance:

$$\begin{aligned} \text{up: } R_T &= \frac{\alpha R_2}{R_2 - \alpha} - R_3 & \alpha &= \frac{V_{ref}}{V_{O'} - V_{ref}} \cdot R_1 \\ \text{down: } R_T &= \frac{\alpha R_1}{R_1 - \alpha} - R_3 & \alpha &= \frac{V_{O'} - V_{ref}}{V_{ref}} \cdot R_2 \end{aligned}$$

$R_T$  is Trim resistance  
 $\alpha$  is a self-defined parameter, with no real meaning.

Vout(V)	R1(K $\Omega$ )	R2(K $\Omega$ )	R3(K $\Omega$ )	Vref(V)
3.3	4.801	2.87	15	1.24
5	2.894	2.87	10	2.5
12	11.000	2.87	17.4	2.5
15	14.494	2.87	17.4	2.5
24	24.872	2.87	20	2.5

It is not allowed to connect modules output in parallel to enlarge the power.

### Mechanical dimensions and footprint

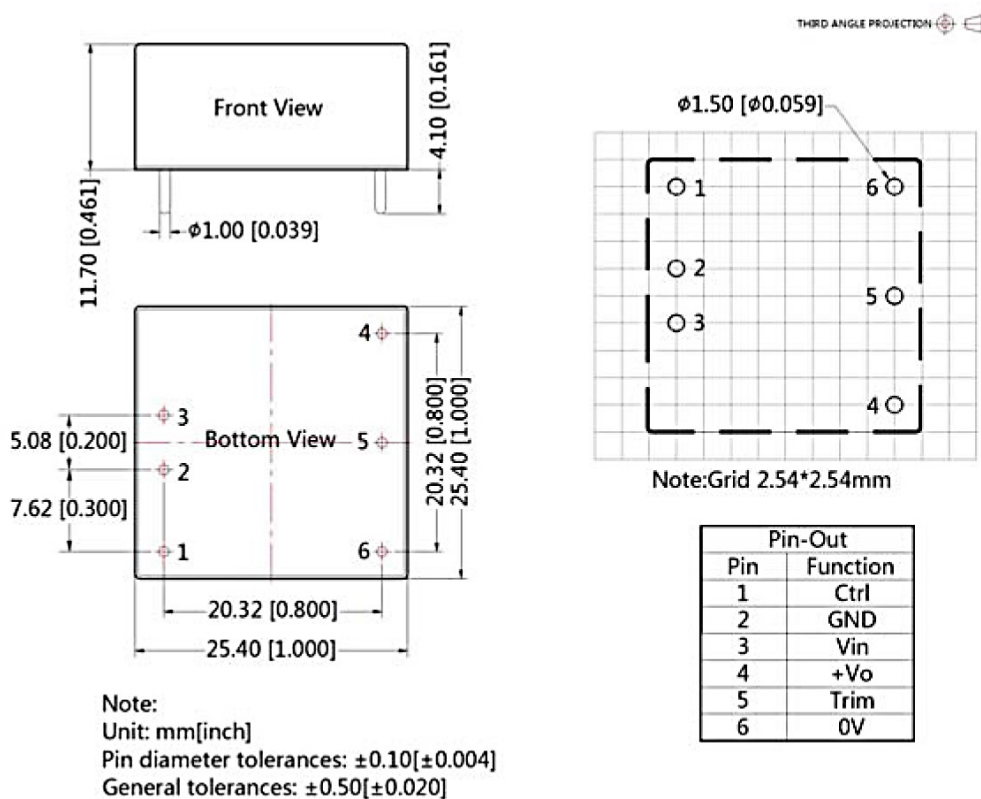

## 15DMWE4\_1.5 series

15W - Single Output - Wide Input - Isolated & Regulated  
1" x 1" DC-DC Converter

### Mechanical dimensions with heatsink

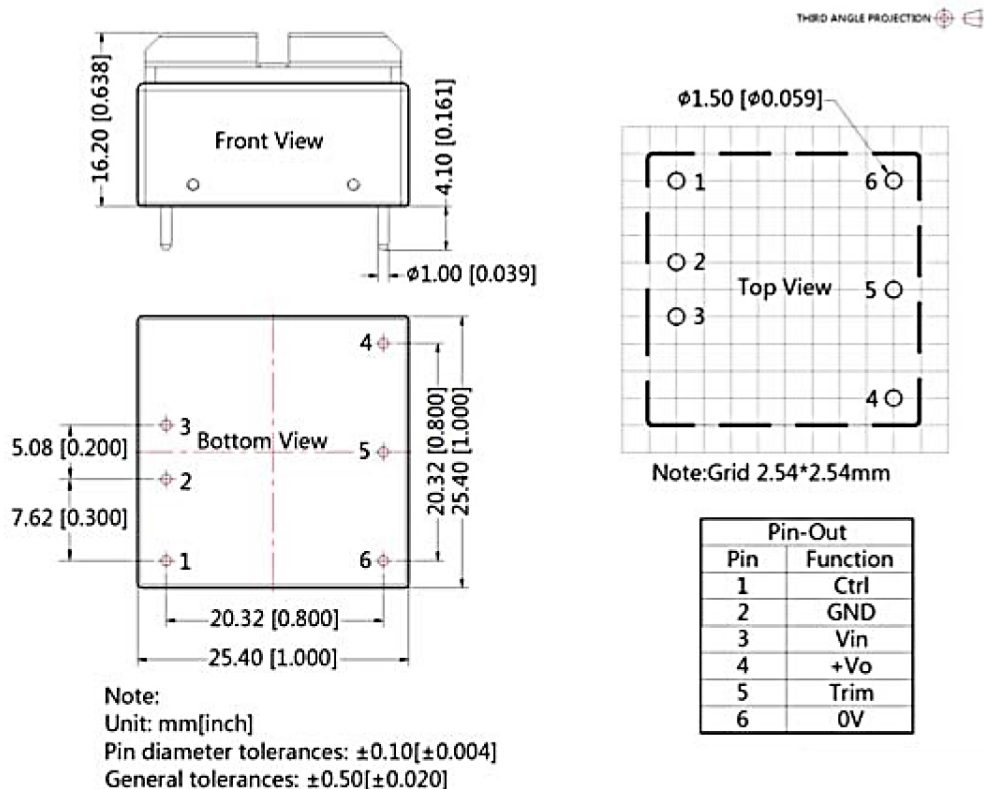

### Wiring mounting

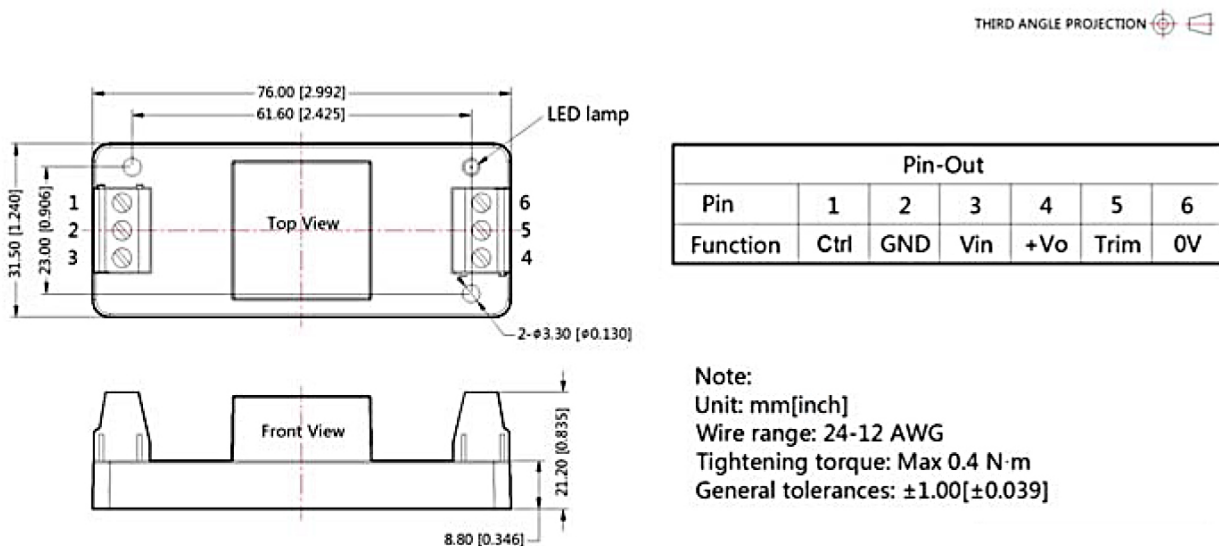

## 15DMWE4\_1.5 series

15W - Single Output - Wide Input - Isolated & Regulated  
1" x 1" DC-DC Converter

### Wiring mounting with heatsink

THIRD ANGLE PROJECTION 

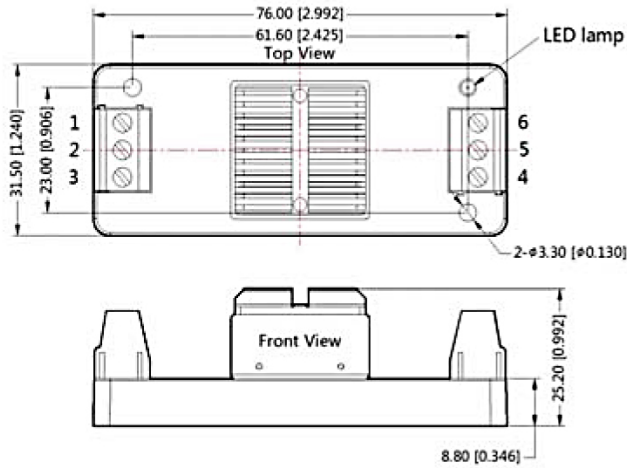

Pin-Out						
Pin	1	2	3	4	5	6
Function	Ctrl	GND	Vin	+Vo	Trim	0V

Note:  
Unit: mm[inch]  
Wire range: 24-12 AWG  
Tightening torque: Max 0.4 N·m  
General tolerances:  $\pm 1.00[\pm 0.039]$

### Rail mounting

THIRD ANGLE PROJECTION 

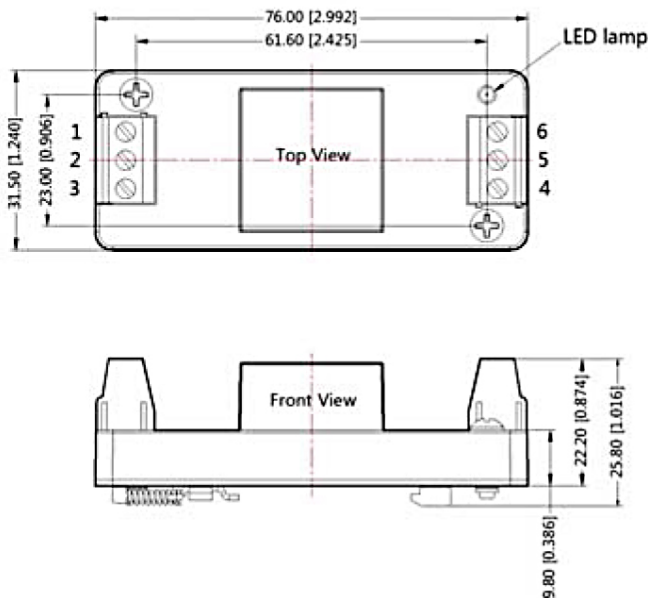

Pin-Out						
Pin	1	2	3	4	5	6
Function	Ctrl	GND	Vin	+Vo	Trim	0V

Note:  
Unit: mm[inch]  
Wire range: 24-12 AWG  
Tightening torque: Max 0.4 N·m  
Mounting rail: TS35  
General tolerances:  $\pm 1.00[\pm 0.039]$

## 15DMWE4\_1.5 series

15W - Single Output - Wide Input - Isolated & Regulated  
1" x 1" DC-DC Converter

### Rail mounting with heatsink

THIRD ANGLE PROJECTION 

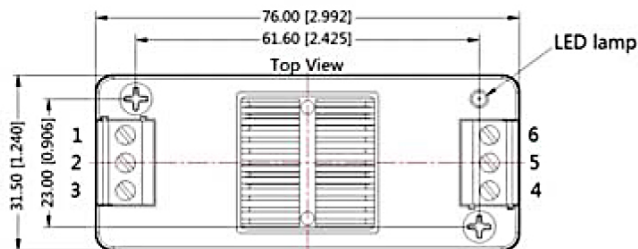

Pin-Out						
Pin	1	2	3	4	5	6
Function	Ctrl	GND	Vin	+Vo	Trim	0V

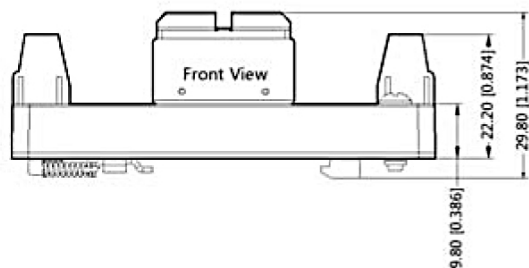

**Note:**  
Unit: mm[inch]  
Wire range: 24-12 AWG  
Tightening torque: Max 0.4 N·m  
General tolerances:  $\pm 1.00[\pm 0.039]$

**Note:**

1. The maximum capacitive loads offered were tested at input voltage range and full load.
2. Only typical model listed. Non-standard models will be different from the above, please contact us for more details.
3. All specifications are measured at TA=25°C, humidity<75%, nominal input voltage and rated output load unless otherwise specified.
4. In this datasheet, all the test methods of indications are based on corporate standards.
5. We can provide product customization service, please contact our technicians directly for specific information.
6. Our products shall be classified according to ISO14001 and related environmental laws and regulations, and shall be handled by qualified units.