

Data sheet | Item number: 899-631/476-000

Distribution box; Single-phase current (230 V); 1 input; 4 outputs; Cod. A;  
MIDI

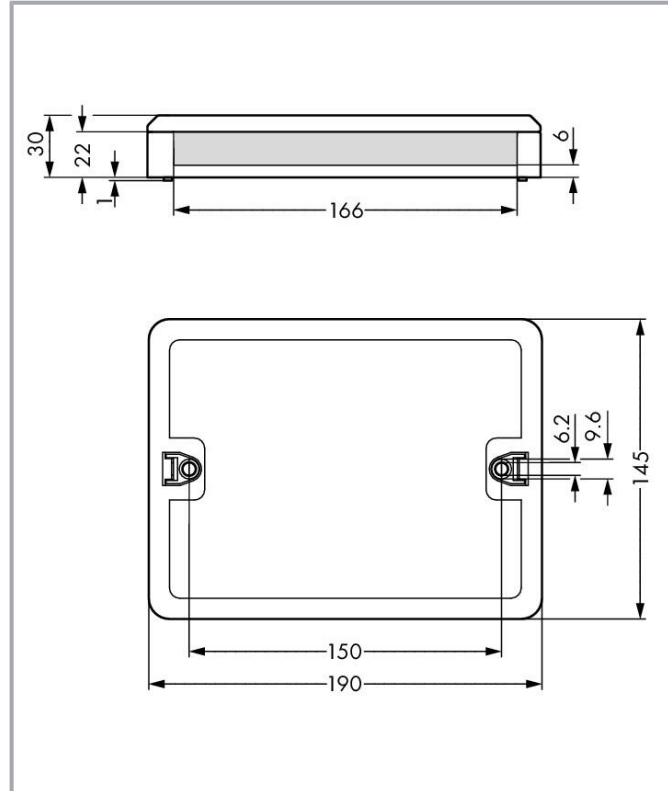

[www.wago.com/899-631/476-000](http://www.wago.com/899-631/476-000)

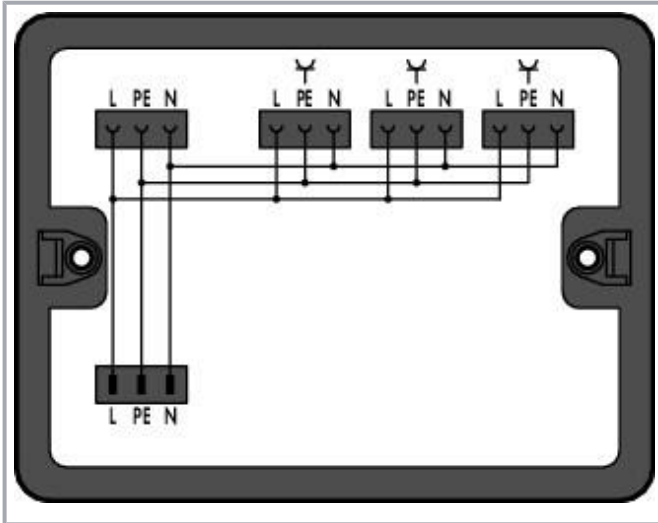

## Item description

### Distribution box *WINSTA*® with protection against mismating

The distribution box from the *WINSTA*® product line with protection against mismating guarantees you the greatest possible flexibility in electrical installation. With WAGO, you get enjoy the advantages of a large selection of accessories for the *WINSTA*® product line. For greater protection in electrical installations, the distribution box is equipped with mechanical protection against mismating. The distribution box offers protection against contact with live components in accordance with protection type IP20 (When mated: IP2xC (These compact connectors are not designed for use in open, easily accessible areas!)). The *WINSTA*® distribution box with A coding in white or black is normally used for general mains applications in power distribution. This distribution box is used for electrical currents up to 20 A. Thus the product is also suitable for high power loads.

Subject to changes. Please also observe the further product documentation!

WAGO GmbH & Co. KG  
Hansastr. 27  
32423 Minden  
Phone: +49571 887-0 | Fax: +49571 887-169  
Email: [info.de@wago.com](mailto:info.de@wago.com) | Web: [www.wago.com](http://www.wago.com)

Do you have any questions about our products?  
We are always happy to take your call at +49 (571) 887-44222.



## Lower costs through fast commissioning and elimination of service expenses – solutions from WINSTA®

WINSTA® is the pluggable connection system that is optimally tailored to the strict requirements of electrical installation. It offers fast, secure and, above all, error-free installation of components and cables. Now you can also cut installation costs without compromising quality and safety: The WINSTA® distribution box with protection against mismating reduces the need for servicing and prevents unnecessary downtime.

- effective protection against mismating
- clear slot identification for easy commissioning
- saves time, since no wiring is required at the construction site
- suitable for any application
- convenient installation and commissioning

### Data

#### Electrical data

#### Ratings per IEC/EN

Ratings per	IEC/EN 60664-1
Nominal voltage (III/3)	250 V
Rated impulse voltage (III/3)	4 kV
Rated current	20 A
Legend (ratings)	(III / 3) ≙ Overvoltage category III / Pollution degree 3

#### General

Note on contact resistance	approx. 1 mΩ contact resistance approx. 0.25 mΩ contact transition (plug/socket)
----------------------------	---

#### Physical data

Width	190 mm / 7.48 inches
Height	30 mm / 1.181 inches
Depth	145 mm / 5.709 inches

#### Mechanical Data

Internal wiring	2.5 mm <sup>2</sup>
Application	General mains applications

Subject to changes. Please also observe the further product documentation!



Coding	A
Mounting type	Wall, screw mount Installation on mounting plate
Protection type	IP20; When mated: IP2xC (These compact connectors are not designed for use in open, easily accessible areas!)

### Plug-in connection

Mismating protection	Yes
Note on mismating protection	All <i>WINSTA</i> <sup>®</sup> components are 100% protected against mismating when: a.) plugging different numbers of poles b.) plugging while rotated 180 c.) plugging while laterally staggered d.) plugging one pole
Locking of plug-in connection	locking lever

### Material Data

Note (material data)	Information on material specifications can be found here
Insulation material	Polyamide (PA66)
Flammability class per UL94	V0
Contact material	Copper or copper alloy; surface-treated
Contact plating	Tin
Fire load	30.114 MJ
Weight	281.4 g

### Environmental requirements

Processing temperature	-5 ... +40 °C
Continuous operating temperature	-35 ... +85 °C
Note on continuous operating temperature	Insulating parts for temperatures ≤ 105 °C

### Commercial data

ETIM 8.0	EC002567
ETIM 7.0	EC002567
PU (SPU)	1 pcs
Packaging type	box
Country of origin	DE

Subject to changes. Please also observe the further product documentation!

WAGO GmbH & Co. KG  
Hansastr. 27  
32423 Minden  
Phone: +49571 887-0 | Fax: +49571 887-169  
Email: [info.de@wago.com](mailto:info.de@wago.com) | Web: [www.wago.com](http://www.wago.com)









Do you have any questions about our products?  
We are always happy to take your call at +49 (571) 887-44222.

GTIN	4055143932080
Customs tariff number	85366990990

## Environmental Product Compliance

RoHS Compliance Status	Compliant, No Exemption
------------------------	-------------------------

## Counterpart

	<b>Item no. 770-103</b> Socket; with strain relief housing; 3-pole; Cod. A; 4,00 mm <sup>2</sup> ; black	<a href="http://www.wago.com/770-103">www.wago.com/770-103</a>
	<b>Item no. 770-113</b> Plug; with strain relief housing; 3-pole; Cod. A; 4,00 mm <sup>2</sup> ; black	<a href="http://www.wago.com/770-113">www.wago.com/770-113</a>
	<b>Item no. 770-203</b> Socket; 3-pole; Cod. A; 4,00 mm <sup>2</sup> ; black	<a href="http://www.wago.com/770-203">www.wago.com/770-203</a>
	<b>Item no. 770-203/035-000</b> Socket; with strain relief housing; 3-pole; Cod. A; 4,00 mm <sup>2</sup> ; black	<a href="http://www.wago.com/770-203/035-000">www.wago.com/770-203/035-000</a>
	<b>Item no. 770-213</b> Plug; 3-pole; Cod. A; 4,00 mm <sup>2</sup> ; black	<a href="http://www.wago.com/770-213">www.wago.com/770-213</a>
	<b>Item no. 770-213/035-000</b> Plug; with strain relief housing; 3-pole; Cod. A; 4,00 mm <sup>2</sup> ; black	<a href="http://www.wago.com/770-213/035-000">www.wago.com/770-213/035-000</a>
	<b>Item no. 771-9993/006-101</b> pre-assembled interconnecting cable; Eca; Socket/plug; 3-pole; Cod. A; H05VV-F 3G 1.5 mm <sup>2</sup> ; 1 m; 1,50 mm <sup>2</sup> ; black	<a href="http://www.wago.com/771-9993/006-101">www.wago.com/771-9993/006-101</a>
	<b>Item no. 771-9993/106-101</b> pre-assembled connecting cable; Eca; Socket/open-ended; 3-pole; Cod. A; H05VV-F 3G 1.5 mm <sup>2</sup> ; 1 m; 1,50 mm <sup>2</sup> ; black	<a href="http://www.wago.com/771-9993/106-101">www.wago.com/771-9993/106-101</a>
	<b>Item no. 771-9993/206-101</b> pre-assembled connecting cable; Eca; Plug/open-ended; 3-pole; Cod. A; H05VV-F 3G 1.5 mm <sup>2</sup> ; 1 m; 1,50 mm <sup>2</sup> ; black	<a href="http://www.wago.com/771-9993/206-101">www.wago.com/771-9993/206-101</a>

## Optional accessories

### Mounting

#### Mounting accessories

	<b>Item no.: 899-680</b> Mounting plate; for distribution boxes; gray	<a href="http://www.wago.com/899-680">www.wago.com/899-680</a>
--	--	--

Subject to changes. Please also observe the further product documentation!

## Downloads

### Environmental Product Compliance

#### Compliance Search

Environmental Product Compliance 899-631/476-000

URL

Download

Distribution box; Single-phase current (230 V); 1 input; 4 outputs; Cod. A; MIDI

---

## Installation Notes

### Installation



Securing the mounting plate with WINSTA®  
Distribution Box to the wall (e.g., via stud gun).

## Product family

### WINSTA® boxes

WINSTA® ist das Steckverbindersystem, das optimal auf die hohen Anforderungen in der Gebäudeinstallation zugeschnitten ist. Es macht die Elektroinstallation steckbar und dadurch schnell, sicher und fehlerfrei. Dies gilt auch in weiteren Anwendungen wie z. B. im Schiffbau, in der Bahntechnik oder in der Industrie.

[Show all products from the family](#)

Subject to changes. Please also observe the further product documentation!