

PART NUMBER	CKTS	QUANTITY PER BAG	BAGS PER CARTON	PARTS PER CARTON (SPQ)	MOISTURIZATION METHOD 	PANEL LOCK
215922-0201	2	3000	4	12000	NO MOISTURIZATION	WITHOUT
215922-0401	4	2600	4	10400		
215922-0601	6	2000	4	8000		
215922-0801	8	1700	4	6800		
215922-1001	10	1400	4	5600		
215922-1201	12	1000	4	4000		
215922-1401	14	800	4	3200		
215922-1601	16	800	4	3200		
215922-1801	18	600	4	2400		
215922-2001	20	600	4	2400		
215922-2201	22	600	4	2400		
215922-2401	24	450	4	1800		
215922-0200	2	2000	4	8000	SEE SHEET 2	WITH
215922-0400	4	1800	4	7200		
215922-0600	6	1600	4	6400		
215922-0800	8	1100	4	4400		
215922-1000	10	1000	4	4000		
215922-1200	12	900	4	3600		
215922-1400	14	800	4	3200		
215922-1600	16	700	4	2800		
215922-1800	18	600	4	2400		
215922-2000	20	600	4	2400		
215922-2200	22	400	4	1600		
215922-2400	24	350	4	1400		

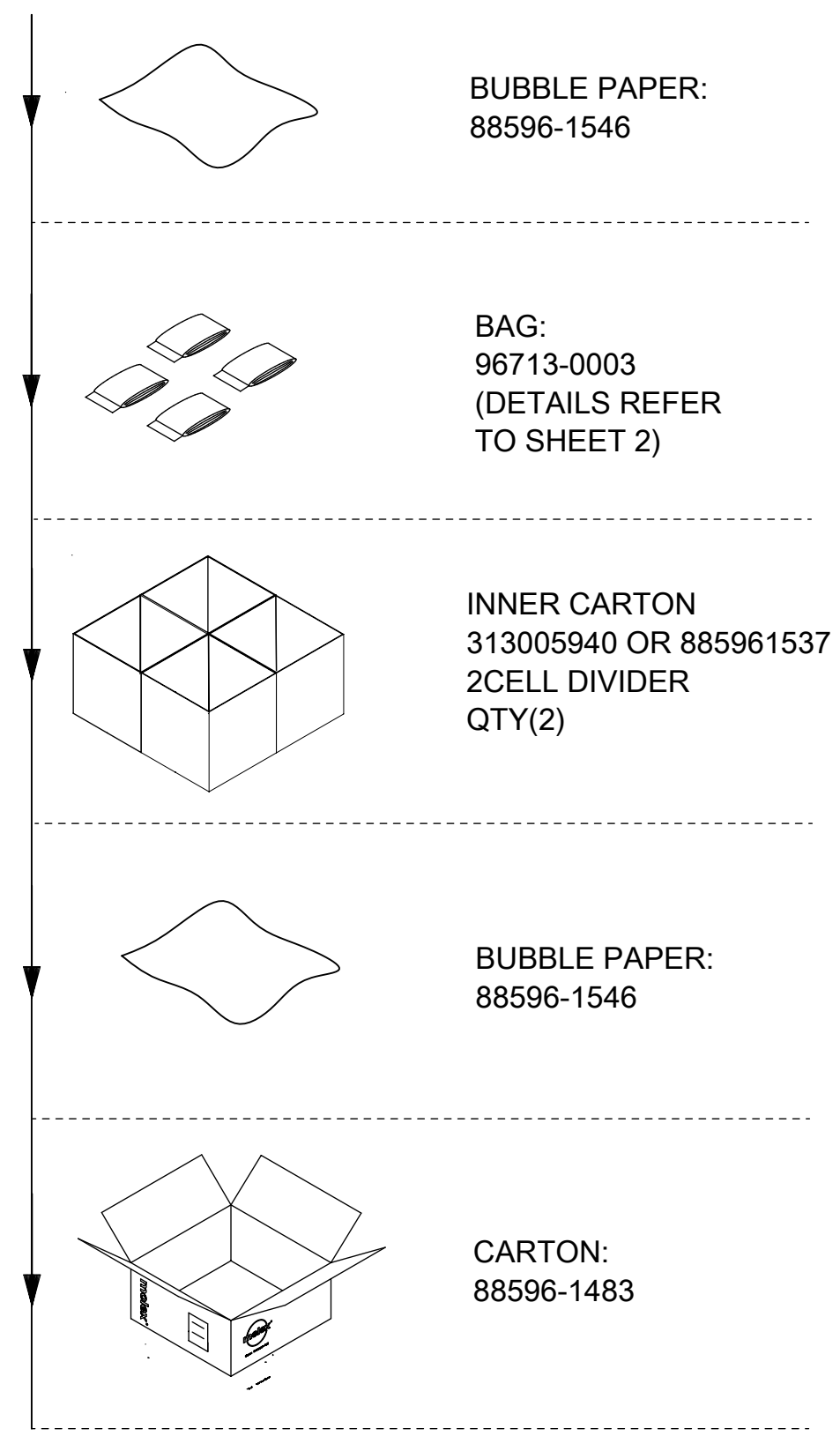

TBD: NO PRODUCTION, TO BE ADDED AFTER BEING PRODUCED.

- NOTES:
1. MOISTURIZATION METHOD DESCRIPTIONS REFER TO SHEET 2.
 2. STANDARD PACKAGE QUANTITY (SPQ) SEE ABOVE CHART.
 3. PACKAGE WAY FOLLOW RIGHT ILLUSTRATION.
 4. ALL PACKAGE MATERIAL AND PRODUCT COMPLIANT TO RoHS DIRECTIVE 2011/65/EU AND ELV DIRECTIVE 2000/53/EC.

FUNCTIONAL SYMBOLS	THIS DRAWING CONTAINS INFORMATION THAT IS PROPRIETARY TO MOLEX ELECTRONIC TECHNOLOGIES, LLC AND SHOULD NOT BE USED WITHOUT WRITTEN PERMISSION		CURRENT REV DESC:		molex				
	mm	1:1							
DIVISIONAL SYMBOLS	GENERAL TOLERANCES (UNLESS SPECIFIED)		EC NO: 725570 DRWN: GLLI 2022/08/29 CHK'D: XQZHANG 2022/10/31 APPR: XQZHANG 2022/10/31		PACKING SPEC FOR MICRO-FIT PLUS WTW HSG				
	ANGULAR TOL ± °				PRODUCT CUSTOMER DRAWING				
	4 PLACES	±			DOCUMENT NUMBER		DOC TYPE	DOC PART	REVISION
	3 PLACES	± 0.1			2159220000-PK		PSD	000	B
	2 PLACES	± 0.3			MATERIAL NUMBER		CUSTOMER		SHEET NUMBER
1 PLACE	± 0.5	215922				1 OF 2			
0 PLACES	±	DRAFT WHERE APPLICABLE MUST REMAIN WITHIN DIMENSIONS		THIRD ANGLE PROJECTION					
		DRAWING		SERIES					
		A3-SIZE		215922					

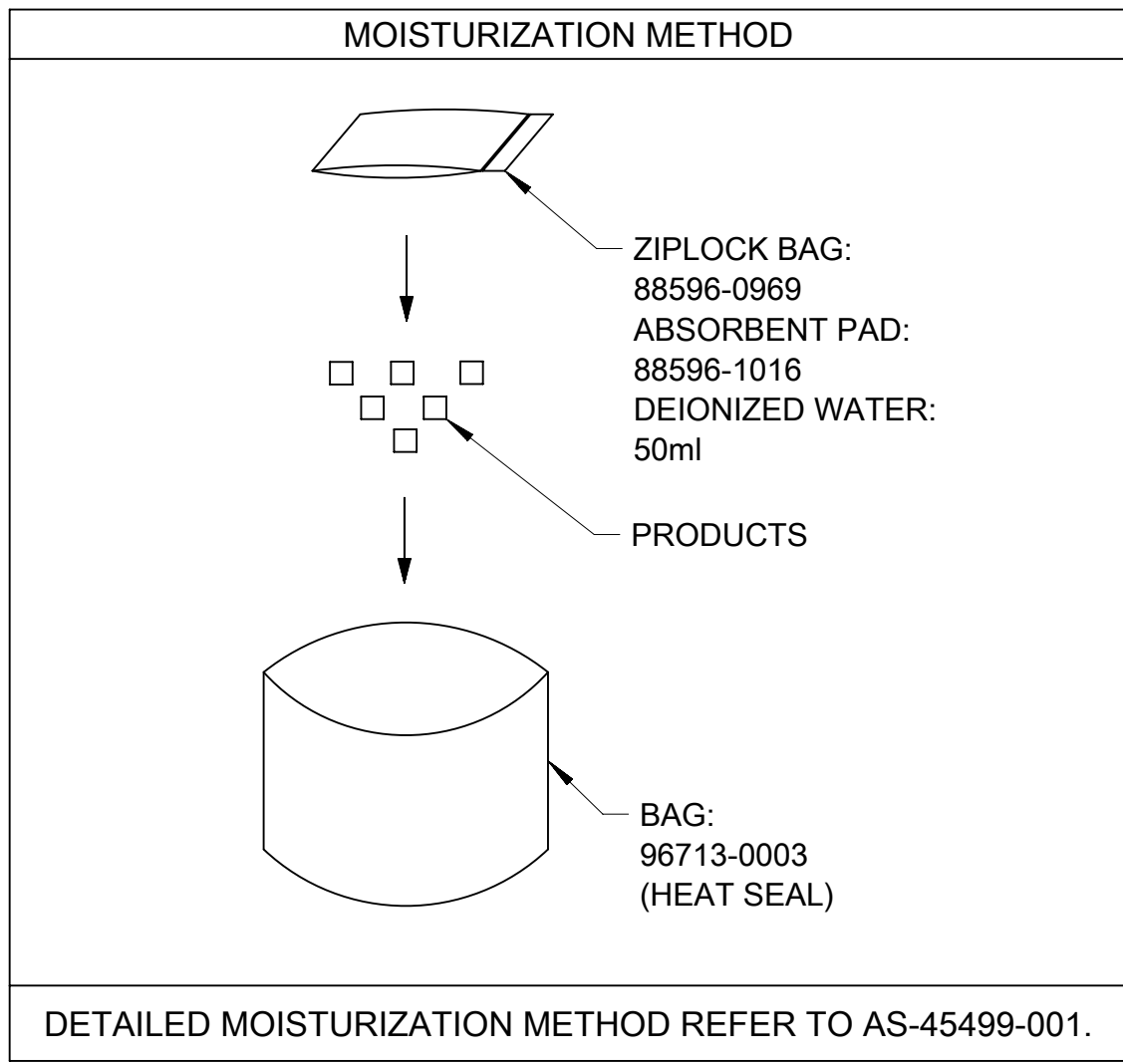

FUNCTIONAL SYMBOLS	THIS DRAWING CONTAINS INFORMATION THAT IS PROPRIETARY TO MOLEX ELECTRONIC TECHNOLOGIES, LLC AND SHOULD NOT BE USED WITHOUT WRITTEN PERMISSION		
$\nabla_A = 0$	DIMENSION UNITS	SCALE	CURRENT REV DESC:
	mm	1:1	
$\nabla_E = 0$	GENERAL TOLERANCES (UNLESS SPECIFIED)		
$\nabla_P = 0$	ANGULAR TOL ± °		
DIVISIONAL SYMBOLS			EC NO: 725570 DRWN: GLLI 2022/08/29 CHK'D: XQZHANG 2022/10/31 APPR: XQZHANG 2022/10/31 INITIAL REVISION: DRWN: GLLI 2021/10/28 APPR: XQZHANG 2021/11/15
	4 PLACES	±	
	3 PLACES	± 0.1	
	2 PLACES	± 0.3	
	1 PLACE	± 0.5	
	0 PLACES	±	
DRAFT WHERE APPLICABLE MUST REMAIN WITHIN DIMENSIONS			THIRD ANGLE PROJECTION
			DRAWING
		A3-SIZE	SERIES
		215922	MATERIAL NUMBER
			CUSTOMER
			SHEET NUMBER
			2 OF 2

PACKING SPEC FOR MICRO-FIT PLUS WTW HSG

PRODUCT CUSTOMER DRAWING

FREE HANGING PLUG PARTS

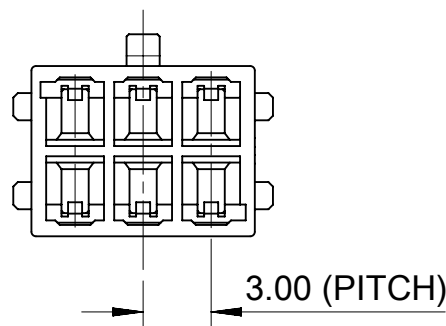
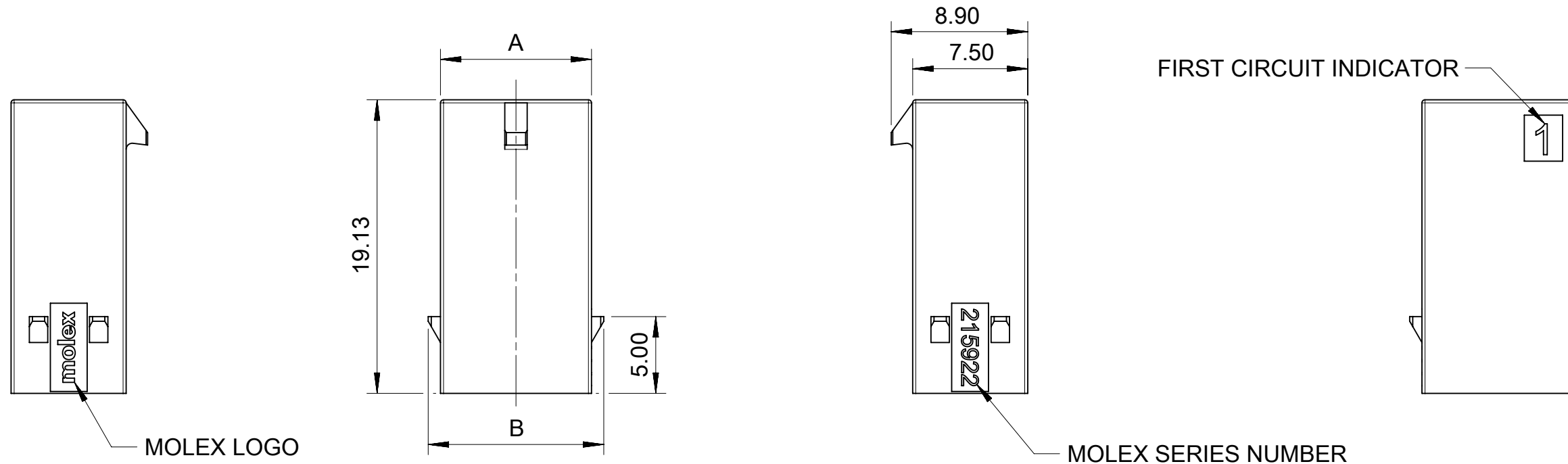

PART No	DIM'A'	DIM'B'	CKT SIZE
215922-0201	3.85	5.45	2
215922-0401	6.85	8.45	4
215922-0601	9.85	11.45	6
215922-0801	12.85	14.45	8
215922-1001	15.85	17.45	10
215922-1201	18.85	20.45	12
215922-1401	21.85	23.45	14
215922-1601	24.85	26.45	16
215922-1801	27.85	29.45	18
215922-2001	30.85	32.45	20
215922-2201	33.85	35.45	22
215922-2401	36.85	38.45	24

- NOTES:
1. MATERIAL: PA66, 94V-0, BLACK.
 2. PRODUCT SPECIFICATION: 2159530000-PS.
 3. PACKAGE SPECIFICATION: 2159220000-PK.
 4. TO USE WITH TERMINAL OF 2015953-****.
 5. TO USE WITH TPA OF 206462-****.
 6. TO MATE WITH RECEPTACLE OF 206461-****.
 7. PARTS CONFORM TO CLASS 'B' REQUIREMENTS OF COSMETIC SPECIFICATION PS-45499-002.

FUNCTIONAL SYMBOLS	THIS DRAWING CONTAINS INFORMATION THAT IS PROPRIETARY TO MOLEX ELECTRONIC TECHNOLOGIES, LLC AND SHOULD NOT BE USED WITHOUT WRITTEN PERMISSION		CURRENT REV DESC:					
	$\nabla_A = 0$ $\nabla_F = 0$ $\nabla_V = 0$	DIMENSION UNITS: mm SCALE: 1:1						
DIVISIONAL SYMBOLS	4 PLACES	±	EC NO: 712744	2022/07/01	PLUG HOUSING OF MICRO-FIT PLUS WTW DR POWER CONNECTOR			
	3 PLACES	±	DRWN: GLLI	2022/07/05				
	2 PLACES	± 0.2	CHK'D: XQZHANG	2022/07/05	PRODUCT CUSTOMER DRAWING			
	1 PLACE	± 0.3	APPR: XQZHANG	2022/07/05				
0 PLACES	±	INITIAL REVISION:		DOCUMENT NUMBER	DOC TYPE	DOC PART	REVISION	
DRAFT WHERE APPLICABLE MUST REMAIN WITHIN DIMENSIONS		THIRD ANGLE PROJECTION	DRAWING	SERIES	MATERIAL NUMBER	CUSTOMER	SHEET NUMBER	
			A3-SIZE	215922	2159220000-SD	GENERAL MARKET	000	A1

FREE HANGING PLUG PARTS

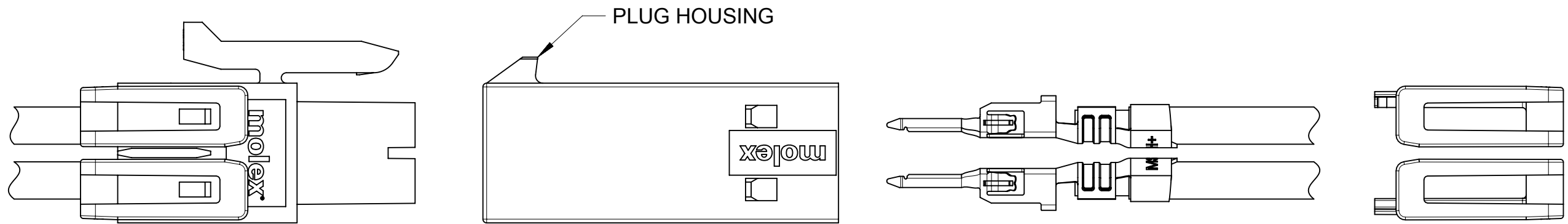
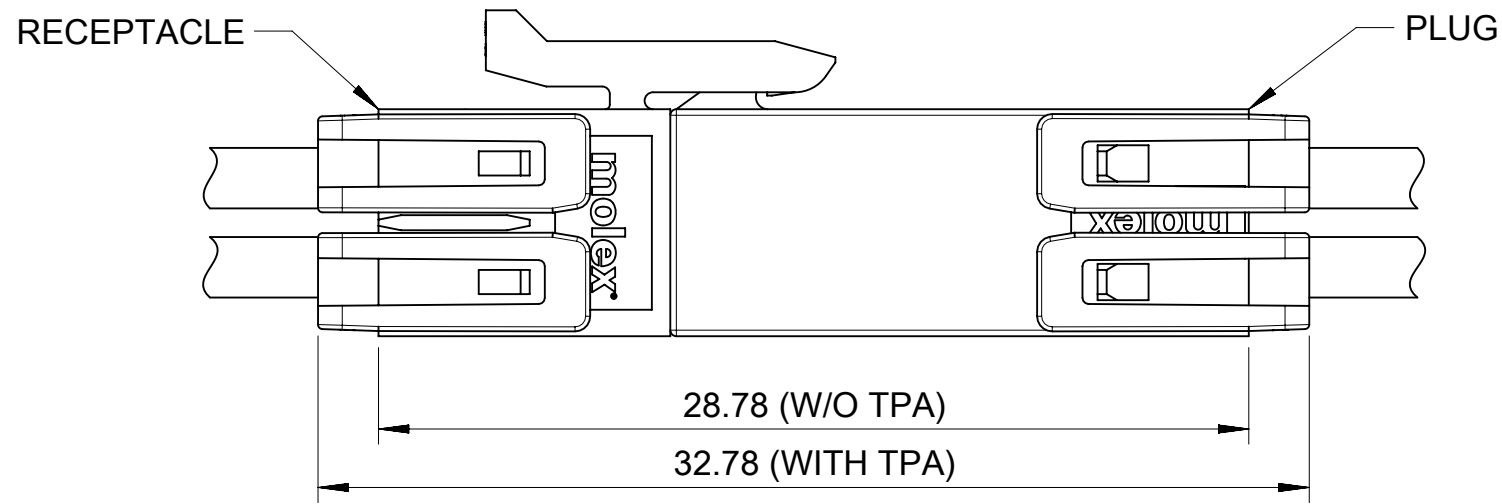

←
TERMINAL AND TPA ORIENTATION

FUNCTIONAL SYMBOLS	THIS DRAWING CONTAINS INFORMATION THAT IS PROPRIETARY TO MOLEX ELECTRONIC TECHNOLOGIES, LLC AND SHOULD NOT BE USED WITHOUT WRITTEN PERMISSION		CURRENT REV DESC:		molex					
	△/A = 0	mm							SCALE 1:1	PLUG HOUSING OF MICRO-FIT PLUS WTW DR POWER CONNECTOR
DIVISIONAL SYMBOLS	GENERAL TOLERANCES (UNLESS SPECIFIED)				EC NO: 712744					
	ANGULAR TOL ± °				DRWN: GLLI 2022/07/01					
	4 PLACES ±				CHK'D: XQZHANG 2022/07/05					
	3 PLACES ±				APPR: XQZHANG 2022/07/05					
	2 PLACES ± 0.2				INITIAL REVISION:					
1 PLACE ± 0.3				DRWN: GLLI 2021/01/29						
0 PLACES ±				APPR: XQZHANG 2021/11/15						
DRAFT WHERE APPLICABLE MUST REMAIN WITHIN DIMENSIONS		THIRD ANGLE PROJECTION	DRAWING	SERIES	MATERIAL NUMBER	CUSTOMER	DOCUMENT NUMBER	DOC TYPE	DOC PART	REVISION
			A3-SIZE	215922	2159220000-SD	GENERAL MARKET	2159220000-SD	PSD	000	A1

FREE HANGING PLUG PARTS

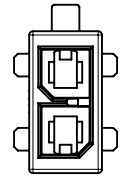

2 CKT

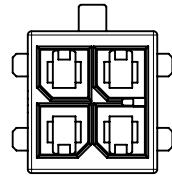

4 CKT

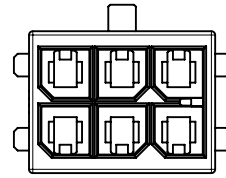

6 CKT

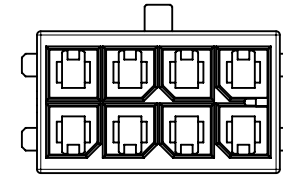

8 CKT

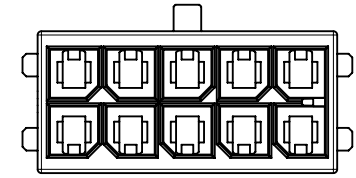

10 CKT

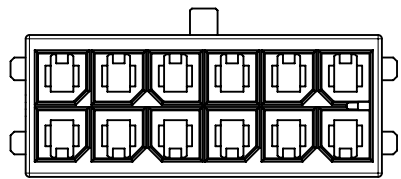

12 CKT

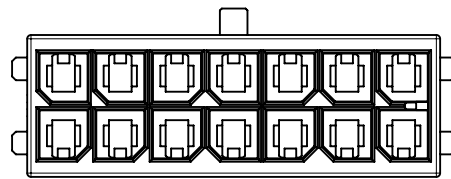

14 CKT

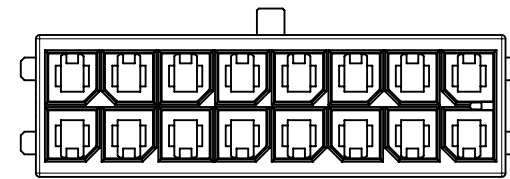

16 CKT

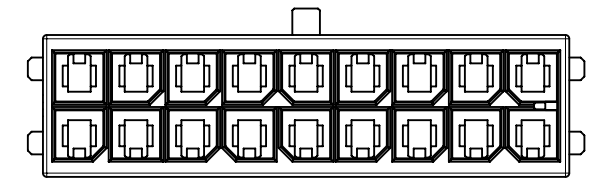

18 CKT

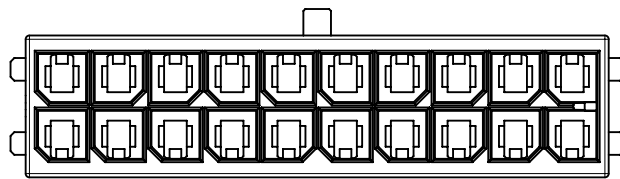

20 CKT

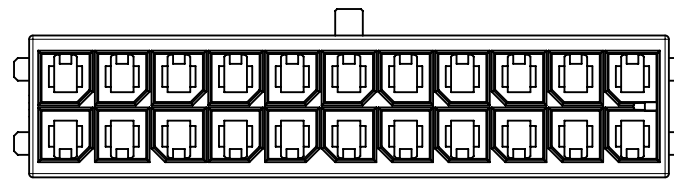

22 CKT

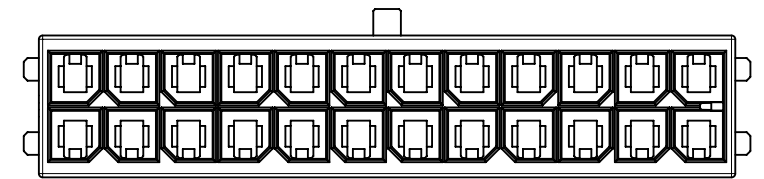

24 CKT

FUNCTIONAL SYMBOLS	THIS DRAWING CONTAINS INFORMATION THAT IS PROPRIETARY TO MOLEX ELECTRONIC TECHNOLOGIES, LLC AND SHOULD NOT BE USED WITHOUT WRITTEN PERMISSION		CURRENT REV DESC:		molex				
	4 PLACES	±							PLUG HOUSING OF MICRO-FIT PLUS WTW DR POWER CONNECTOR
GENERAL TOLERANCES (UNLESS SPECIFIED)	ANGULAR TOL		±		PRODUCT CUSTOMER DRAWING				
3 PLACES	±	±		EC NO: 712744	2022/07/01		DOCUMENT NUMBER		
2 PLACES	± 0.2	±		DRWN: GLLI	2022/07/05		2159220000-SD		
1 PLACE	± 0.3	±		APP: XQZHANG	2022/07/05		PSD 000 A1		
0 PLACES	±	±		INITIAL REVISION:	2021/01/29		DOC TYPE		
DRAFT WHERE APPLICABLE MUST REMAIN WITHIN DIMENSIONS		THIRD ANGLE PROJECTION		DRWN: GLLI	2021/11/15		DOC PART		
				APP: XQZHANG			REVISION		
				DRAWING		SERIES		SHEET NUMBER	
				A3-SIZE		215922		3 OF 6	
				MATERIAL NUMBER		CUSTOMER			
						GENERAL MARKET			

PANEL MOUNT PLUG PARTS

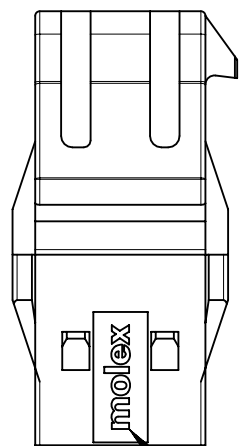

MOLEX LOGO

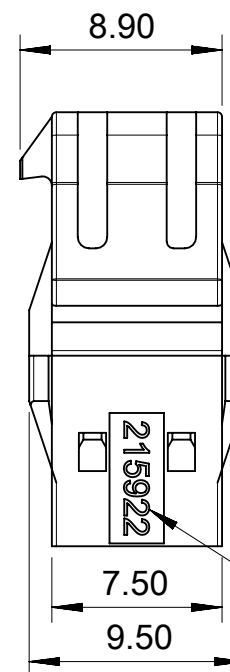
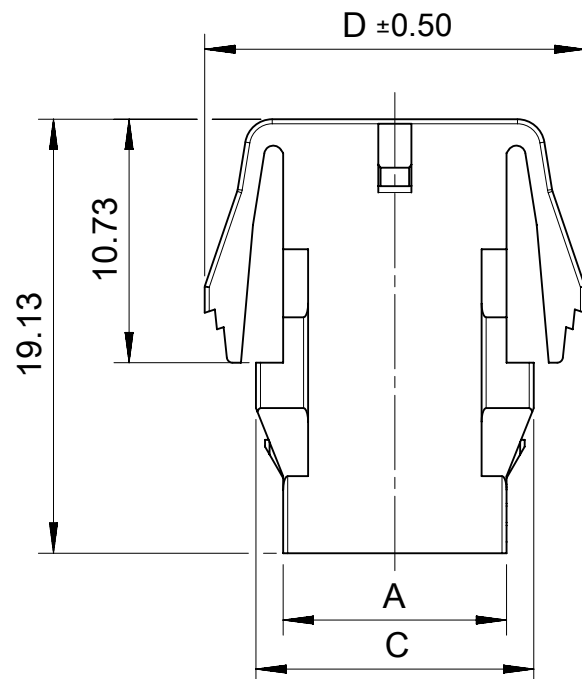

FIRST CIRCUIT INDICATOR

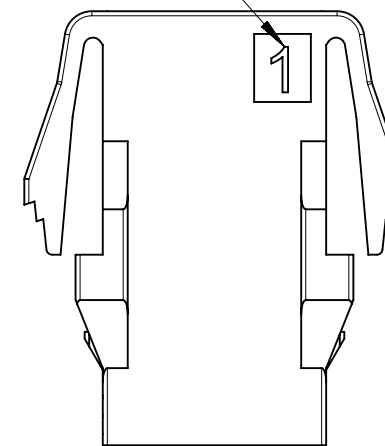

MOLEX SERIES NUMBER

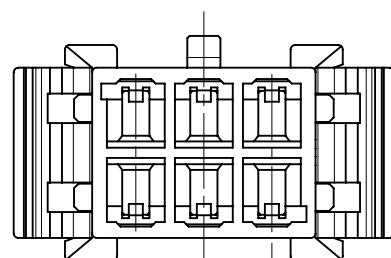

3.00 (PITCH)

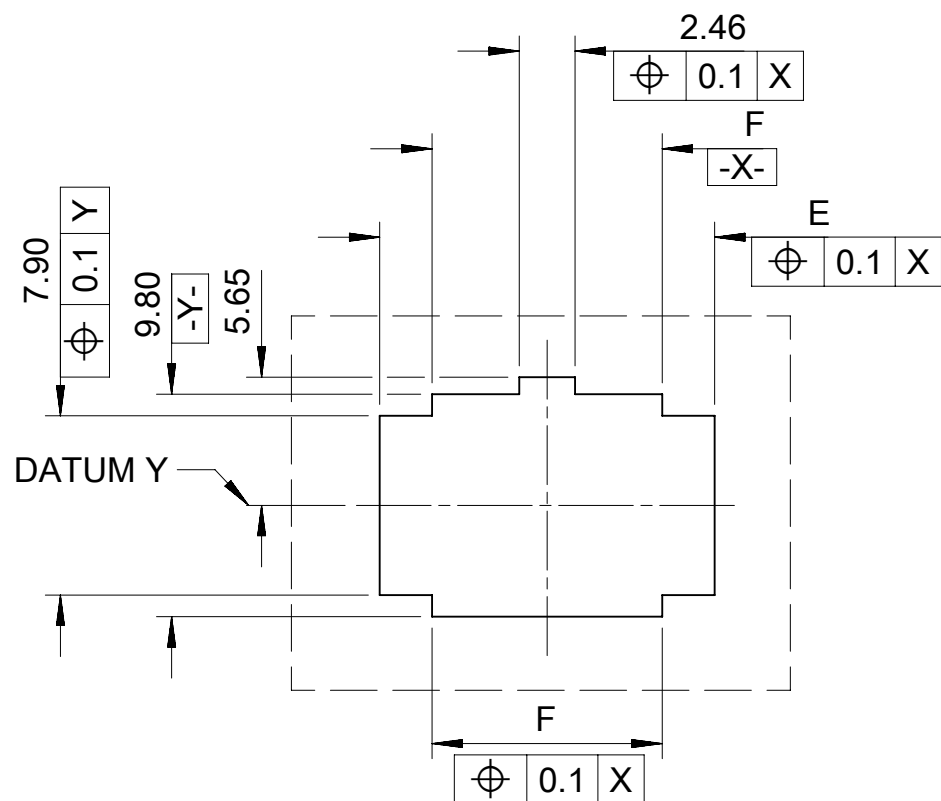

PART No	DIM 'A'	DIM 'C'	DIM 'D'	DIM 'E'	DIM 'F'	CKT SIZE
215922-0200	3.85	6.25	10.77	8.77	4.15	2
215922-0400	6.85	9.25	13.77	11.77	7.15	4
215922-0600	9.85	12.25	16.77	14.77	10.15	6
215922-0800	12.85	15.25	19.77	17.77	13.15	8
215922-1000	15.85	18.25	22.77	20.77	16.15	10
215922-1200	18.85	21.25	25.77	23.77	19.15	12
215922-1400	21.85	24.25	28.77	26.77	22.15	14
215922-1600	24.85	27.25	31.77	29.77	25.15	16
215922-1800	27.85	30.25	34.77	32.77	28.15	18
215922-2000	30.85	33.25	37.77	35.77	31.15	20
215922-2200	33.85	36.25	40.77	38.77	34.15	22
215922-2400	36.85	39.25	43.77	41.77	37.15	24

RECOMMENDED PANEL CUT OUT
(TOLERRANCE +/-0.05 THICKNESS=1.2~2.2MM)

FUNCTIONAL SYMBOLS	THIS DRAWING CONTAINS INFORMATION THAT IS PROPRIETARY TO MOLEX ELECTRONIC TECHNOLOGIES, LLC AND SHOULD NOT BE USED WITHOUT WRITTEN PERMISSION	CURRENT REV DESC:		molex																													
	<table border="1"> <tr> <th>FUNCTIONAL SYMBOLS</th> <th>DIMENSION UNITS</th> <th>SCALE</th> </tr> <tr> <td>$\nabla_A = 0$</td> <td>mm</td> <td>1:1</td> </tr> <tr> <td>$\nabla_E = 0$</td> <td colspan="2">GENERAL TOLERANCES (UNLESS SPECIFIED)</td> </tr> <tr> <td>$\nabla_V = 0$</td> <td colspan="2">ANGULAR TOL ± °</td> </tr> <tr> <td></td> <td>4 PLACES</td> <td>±</td> </tr> <tr> <td></td> <td>3 PLACES</td> <td>±</td> </tr> <tr> <td></td> <td>2 PLACES</td> <td>± 0.2</td> </tr> <tr> <td></td> <td>1 PLACE</td> <td>± 0.3</td> </tr> <tr> <td></td> <td>0 PLACES</td> <td>±</td> </tr> </table>	FUNCTIONAL SYMBOLS	DIMENSION UNITS					SCALE	$\nabla_A = 0$	mm	1:1	$\nabla_E = 0$	GENERAL TOLERANCES (UNLESS SPECIFIED)		$\nabla_V = 0$	ANGULAR TOL ± °			4 PLACES	±		3 PLACES	±		2 PLACES	± 0.2		1 PLACE	± 0.3		0 PLACES	±	EC NO: 712744 DRWN: GLLI 2022/07/01 CHK'D: XQZHANG 2022/07/05 APPR: XQZHANG 2022/07/05
FUNCTIONAL SYMBOLS	DIMENSION UNITS	SCALE																															
$\nabla_A = 0$	mm	1:1																															
$\nabla_E = 0$	GENERAL TOLERANCES (UNLESS SPECIFIED)																																
$\nabla_V = 0$	ANGULAR TOL ± °																																
	4 PLACES	±																															
	3 PLACES	±																															
	2 PLACES	± 0.2																															
	1 PLACE	± 0.3																															
	0 PLACES	±																															
DIVISIONAL SYMBOLS	DRAFT WHERE APPLICABLE MUST REMAIN WITHIN DIMENSIONS		THIRD ANGLE PROJECTION	DRAWING	SERIES	MATERIAL NUMBER	CUSTOMER	SHEET NUMBER																									
				A3-SIZE	215922	2159220000-SD	GENERAL MARKET	4 OF 6																									

PANEL MOUNT PLUG PARTS

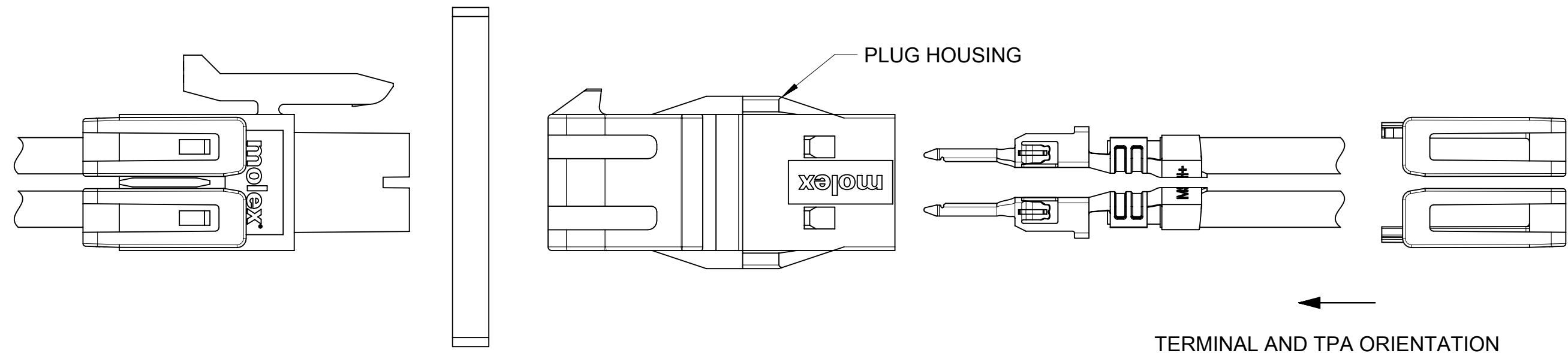
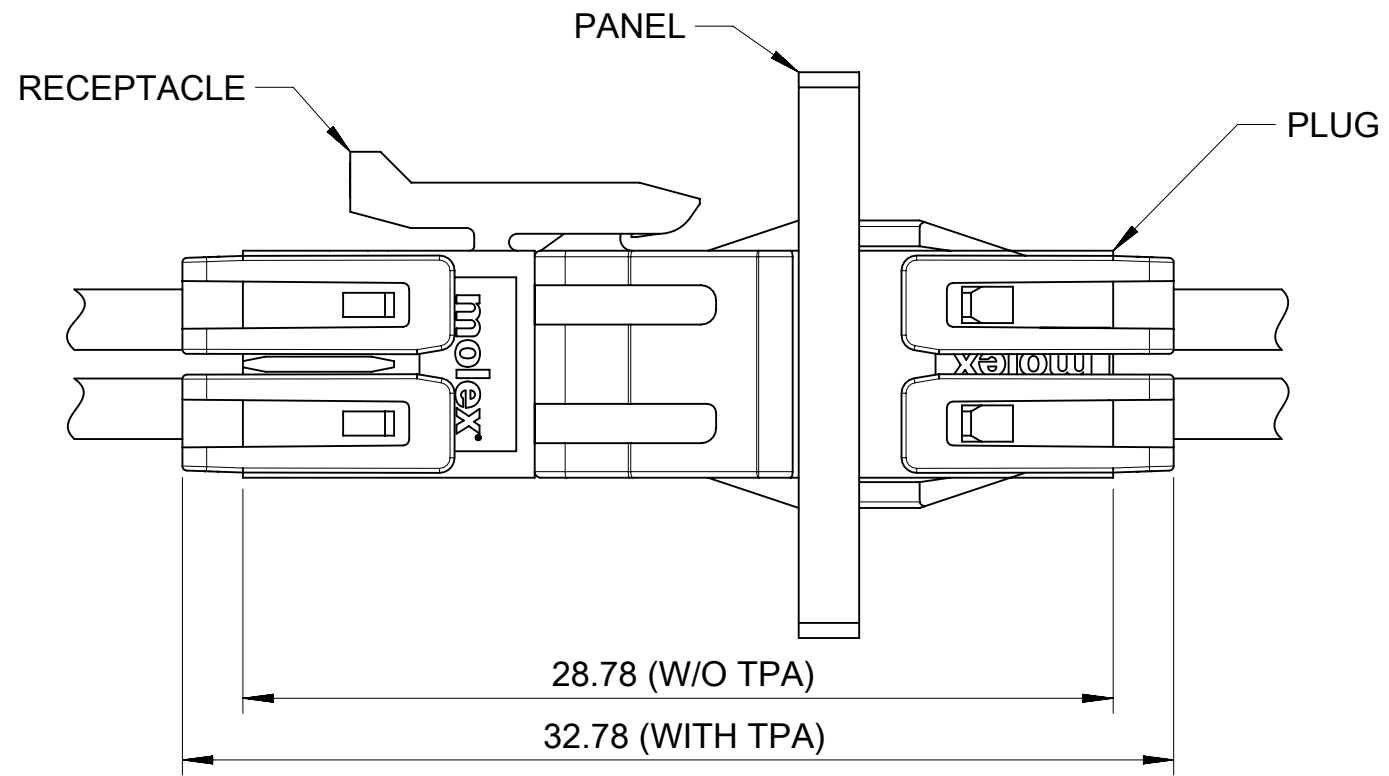

FUNCTIONAL SYMBOLS	THIS DRAWING CONTAINS INFORMATION THAT IS PROPRIETARY TO MOLEX ELECTRONIC TECHNOLOGIES, LLC AND SHOULD NOT BE USED WITHOUT WRITTEN PERMISSION		
	△/A = 0	mm	SCALE 1:1
DIVISIONAL SYMBOLS	CURRENT REV DESC:		
	△/E = 0	GENERAL TOLERANCES (UNLESS SPECIFIED)	
DIVISIONAL SYMBOLS	△/F = 0	ANGULAR TOL ± °	
	4 PLACES	±	
	3 PLACES	±	
	2 PLACES	± 0.2	
	1 PLACE	± 0.3	
0 PLACES	±		
DRAFT WHERE APPLICABLE MUST REMAIN WITHIN DIMENSIONS		THIRD ANGLE PROJECTION	DRAWING A3-SIZE
		SERIES 215922	MATERIAL NUMBER
		CUSTOMER GENERAL MARKET	REVISION 5 OF 6

molex

PLUG HOUSING OF MICRO-FIT PLUS WTW DR POWER CONNECTOR

PRODUCT CUSTOMER DRAWING

DOCUMENT NUMBER: 2159220000-SD

DOC TYPE: PSD

DOC PART: 000

REVISION: A1

PANEL MOUNT PLUG PARTS

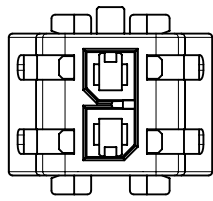

2 CKT

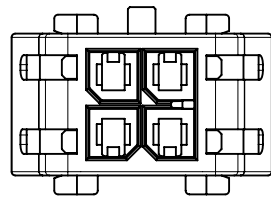

4 CKT

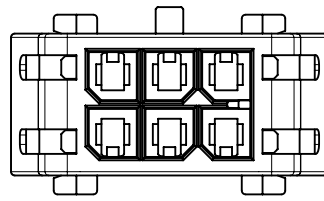

6 CKT

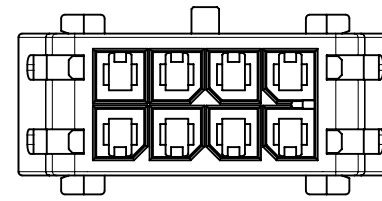

8 CKT

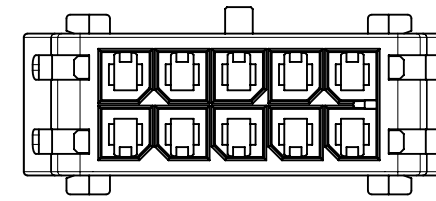

10 CKT

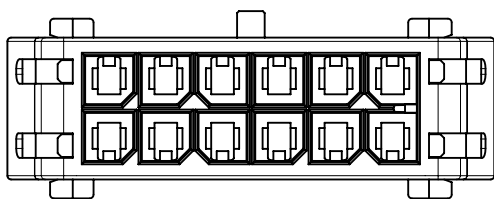

12 CKT

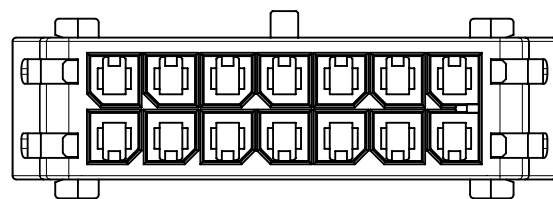

14 CKT

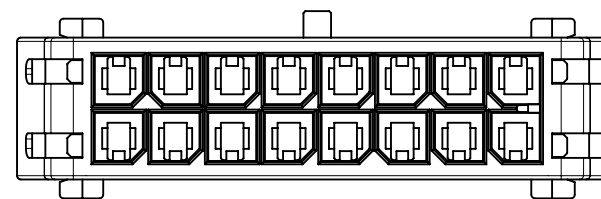

16 CKT

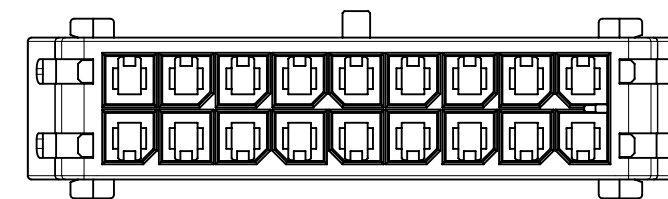

18 CKT

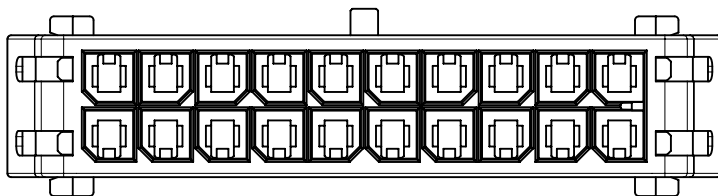

20 CKT

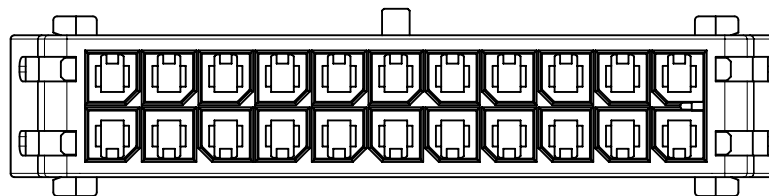

22 CKT

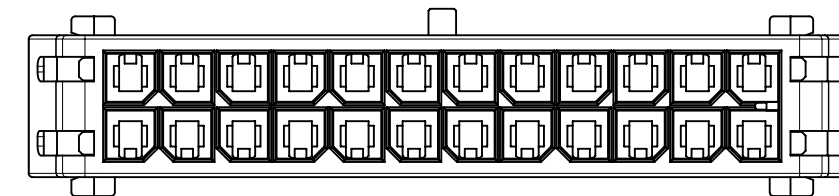

24 CKT

FUNCTIONAL SYMBOLS	THIS DRAWING CONTAINS INFORMATION THAT IS PROPRIETARY TO MOLEX ELECTRONIC TECHNOLOGIES, LLC AND SHOULD NOT BE USED WITHOUT WRITTEN PERMISSION		<div style="text-align: center;">molex</div> PLUG HOUSING OF MICRO-FIT PLUS WTW DR POWER CONNECTOR			
	DIMENSION UNITS: mm SCALE: 1:1	CURRENT REV DESC:				
DIVISIONAL SYMBOLS	GENERAL TOLERANCES (UNLESS SPECIFIED)		PRODUCT CUSTOMER DRAWING			
	ANGULAR TOL ± °		DOCUMENT NUMBER: 2159220000-SD			
	4 PLACES ±	EC NO: 712744		2022/07/01	2022/07/05	
	3 PLACES ±	DRWN: GLLI		2022/07/05	2022/07/05	
	2 PLACES ± 0.2	CHK'D: XQZHANG		2022/07/05	2022/07/05	
1 PLACE ± 0.3	APPR: XQZHANG		INITIAL REVISION:			
0 PLACES ±	APPR: XQZHANG		DRWN: GLLI	2021/01/29	2021/11/15	
DRAFT WHERE APPLICABLE MUST REMAIN WITHIN DIMENSIONS		THIRD ANGLE PROJECTION	DRAWING: A3-SIZE	SERIES: 215922	MATERIAL NUMBER	CUSTOMER: GENERAL MARKET
					DOC TYPE: PSD	DOC PART: 000
					REVISION: A1	SHEET NUMBER: 6 OF 6