

Verpackt im Gurt in Anlehnung an DIN IEC 60286-3
 tape on reel packaging according to DIN IEC 60286-3
 Verpackungseinheit: 240 Stück
 packaging unit: 240 pcs

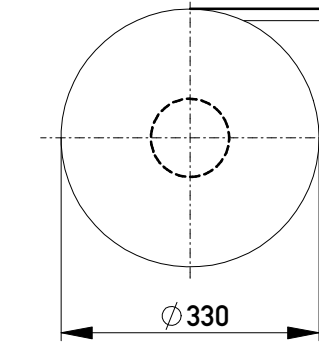

Abspulrichtung - Reel off Direction

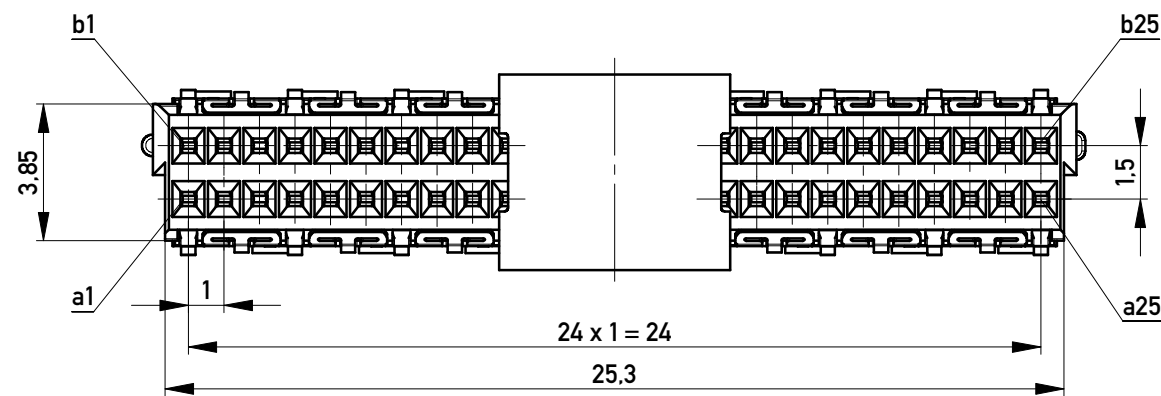
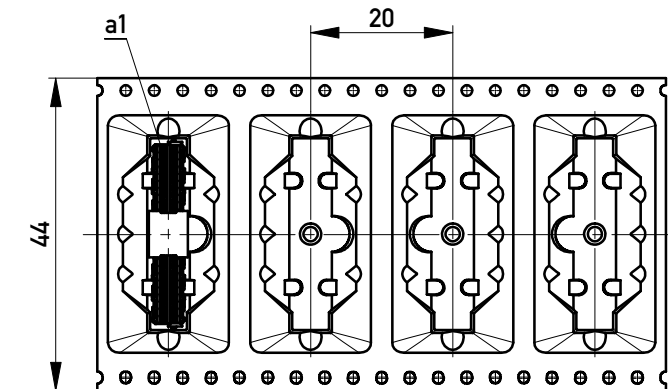

Einzelheit X / detail X
 M 20:1 / scale 20:1

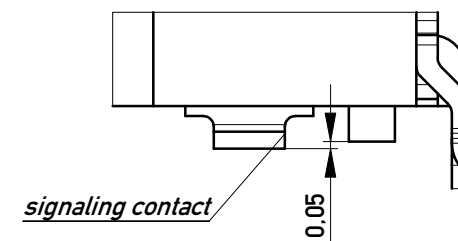

Leiterplatten-Lay-out Vorschlag / PCB-Lay-out Proposal

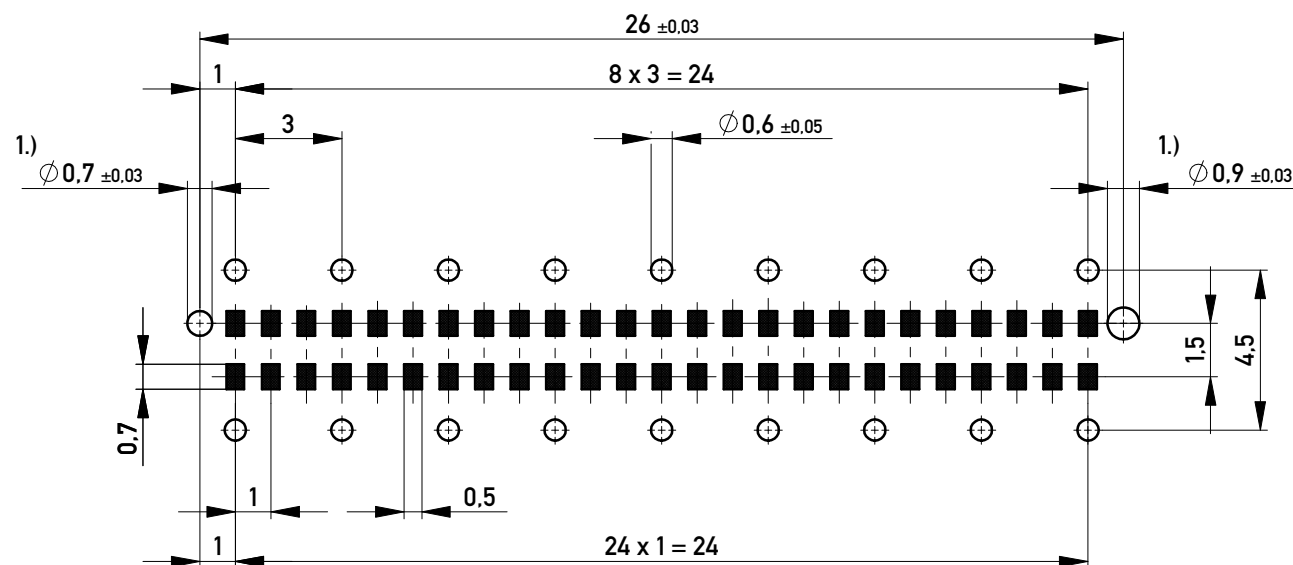



1.) Durchmesser des Bohrers / Drill tool

Anforderungsstufe 1
 Performance Level 1

Kontaktbereich vergoldet
 Mating Area gold plating

Anschlussbereich verzinkt 4-6µm
 Terminal Area 4-6µm tin plating

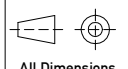
Koplanarität der Anschlüsse ≤ 0,1mm
 Coplanarity Area of Termination ≤ 0,1mm

Information: All rights reserved. Only for Information. To ensure that this is the latest version of this drawing, please contact one of the ERNI companies before using.	Tolerances  All Dimensions in mm	Scale 5:1
	Designation Federleiste 10mm THR, 50 polig Female 10mm THR, 50 contacts	
g Index	20.10.2017 Date	 www.ERNI.com
Class MSPEED		224517 I A3

Copyright by ERNI Production GmbH & Co. KG
 Proprietary notice pursuant to ISO 16016 to be observed.