

THIS DOCUMENT IS THE PROPERTY OF  
KEYSTONE ELECTRONICS CORP. AND  
SHALL NOT BE REPRODUCED, DISTRIBUTED  
OR USED AS A BASIS FOR MANUFACTURE  
WITHOUT PRIOR WRITTEN PERMISSION  
FROM KEYSTONE ELECTRONICS CORP.

ACTUAL SIZE

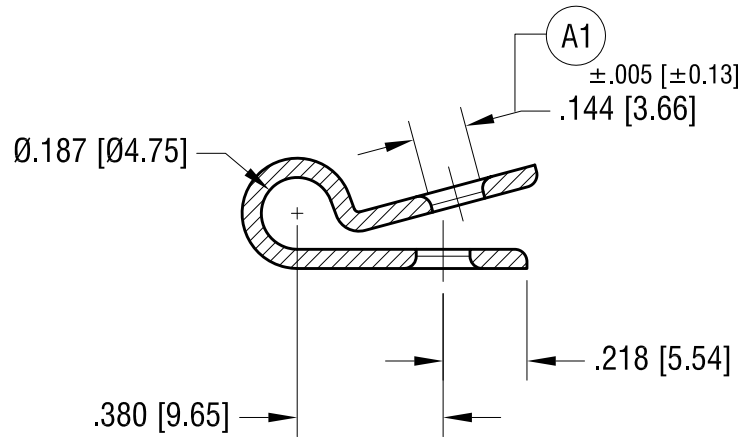
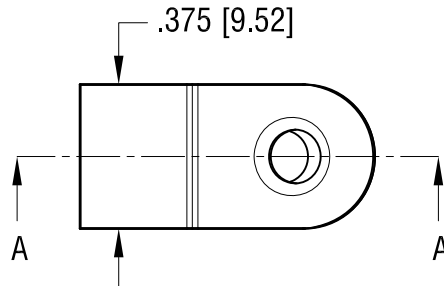

SECTION A-A

**KEYSTONE ELECTRONICS CORP.**

www.keyelco.com • NEW HYDE PARK, NY 11040 • Tel (516) 328-7500

PART NAME

NYLON CABLE CLAMP

MATERIAL

.050 [1.27] TH'K NYLON 6/6

FINISH

NONE

DRN BY

BOONE

DATE

11.02.06

APP'D

RH

SCALE

2X

TOLERANCES

INCH [MM]

DECIMAL ±.005 [±0.13]

ANGULAR ± 1°  
UNLESS OTHERWISE SPECIFIED

CODE

C

DWG NO.

7622

3.03.21 (A1) WAS .140 [3.56]  
CHANGE AS PER ECN 21-024

A

REV.

DATE

DESCRIPTION