



80-mW DIRECTPATH™ STEREO HEADPHONE DRIVER

FEATURES

- **Space Saving Packages**
 - 20-Pin, 4 mm × 4 mm Thin QFN
 - TPA4411 – Thermally Optimized PowerPAD™ Package
 - TPA4411M – Thermally Enhanced PowerPAD™ Package
 - 16-Ball, 2.18 mm × 2.18 mm WCSP
- **Ground-Referenced Outputs Eliminate DC-Bias Voltages on Headphone Ground Pin**
 - No Output DC-Blocking Capacitors
 - Reduced Board Area
 - Reduced Component Cost
 - Improved THD+N Performance
 - No Degradation of Low-Frequency Response Due to Output Capacitors
- **Wide Power Supply Range: 1.8 V to 4.5 V**
- **80-mW/Ch Output Power into 16-Ω at 4.5 V**
- **Independent Right and Left Channel Shutdown Control**
- **Short-Circuit and Thermal Protection**
- **Pop Reduction Circuitry**

APPLICATIONS

- **Notebook Computers**
- **CD / MP3 Players**
- **Smart Phones**
- **Cellular Phones**
- **PDA's**

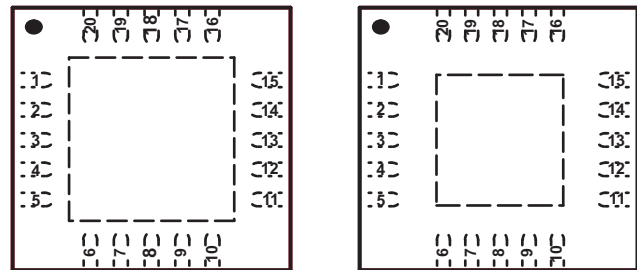

TPA4411RTJ

TPA4411MRTJ

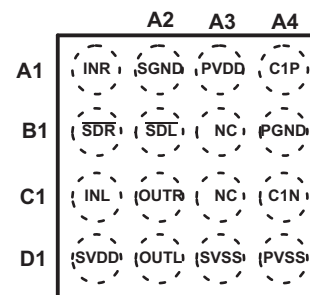

TPA4411YZH

DESCRIPTION

The TPA4411 and TPA4411M are stereo headphone drivers designed to allow the removal of the output DC-blocking capacitors for reduced component count and cost. The TPA4411 and TPA4411M are ideal for small portable electronics where size and cost are critical design parameters.

The TPA4411 and TPA4411M are capable of driving 80 mW into a 16-Ω load at 4.5 V. Both TPA4411 and TPA4411M have a fixed gain of -1.5 V/V and headphone outputs that have ± 8 -kV IEC ESD protection. The TPA4411 and TPA4411M have independent shutdown control for the right and left audio channels.

The TPA4411 is available in a 2.18 mm × 2.18 mm WCSP and 4 mm × 4 mm Thin QFN packages. The TPA4411M is available in a 4 mm × 4 mm Thin QFN package. The TPA4411RTJ package is a thermally optimized PowerPAD™ package allowing the maximum amount of thermal dissipation and the TPA4411MRTJ is a thermally enhanced PowerPAD package designed to match competitive package footprints.



Please be aware that an important notice concerning availability, standard warranty, and use in critical applications of Texas Instruments semiconductor products and disclaimers thereto appears at the end of this data sheet.

PowerPAD, DirectPath are trademarks of Texas Instruments.



These devices have limited built-in ESD protection. The leads should be shorted together or the device placed in conductive foam during storage or handling to prevent electrostatic damage to the MOS gates.

**RTJ (QFN) PACKAGE
(TOP VIEW)**

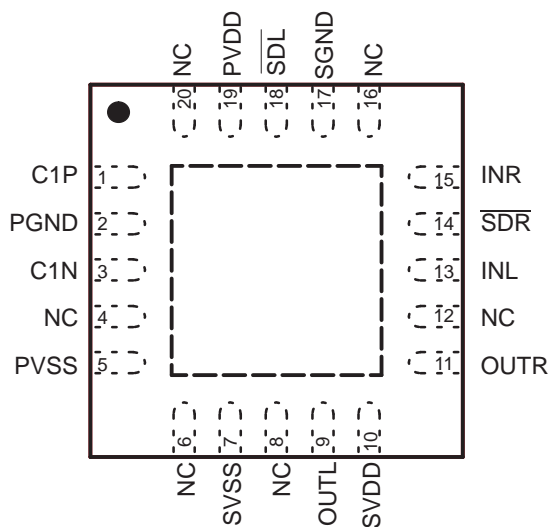

TPA4411RTJ

NC – No internal connection

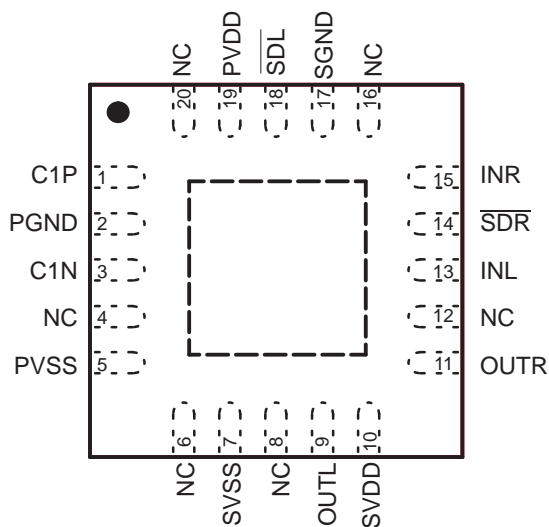

TPA4411MRTJ

NC – No internal connection

**YZH (WCSP) PACKAGE
(TOP VIEW)**

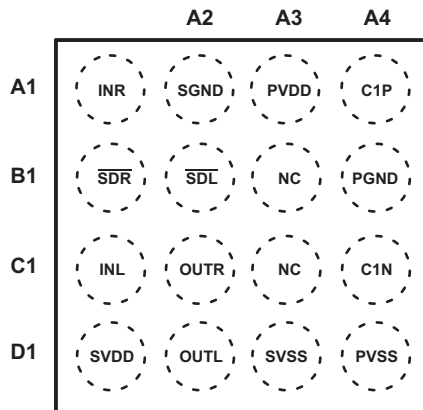

TPA4411YZH

NC - No internal connection

TERMINAL FUNCTIONS

| TERMINAL | | | I/O | DESCRIPTION |
|-------------------------|---------------------------|--------|-----|--|
| NAME | QFN | WCSP | | |
| C1P | 1 | A4 | I/O | Charge pump flying capacitor positive terminal |
| PGND | 2 | B4 | I | Power ground, connect to ground. |
| C1N | 3 | C4 | I/O | Charge pump flying capacitor negative terminal |
| NC | 4, 6, 8, 12, 16, 20 | B3, C3 | | No connection |
| PVSS | 5 | D4 | O | Output from charge pump. |
| SVSS | 7 | D3 | I | Amplifier negative supply, connect to PVSS via star connection. |
| OUTL | 9 | D2 | O | Left audio channel output signal |
| SVDD | 10 | D1 | I | Amplifier positive supply, connect to PVDD via star connection. |
| OUTR | 11 | C2 | O | Right audio channel output signal |
| INL | 13 | C1 | I | Left audio channel input signal |
| $\overline{\text{SDR}}$ | 14 | B1 | I | Right channel shutdown, active low logic. |
| INR | 15 | A1 | I | Right audio channel input signal |
| SGND | 17 | A2 | I | Signal ground, connect to ground. |
| $\overline{\text{SDL}}$ | 18 | B2 | I | Left channel shutdown, active low logic. |
| PVDD | 19 | A3 | I | Supply voltage, connect to positive supply. |
| Exposed Pad | | - | | Exposed pad must be soldered to a floating plane. Do NOT connect to power or ground. |

ABSOLUTE MAXIMUM RATINGS⁽¹⁾

over operating free-air temperature range, $T_A = 25^\circ\text{C}$ (unless otherwise noted)

| | | VALUE / UNIT |
|------------------|--|------------------------------|
| | Supply voltage, AVDD, PVDD | -0.3 V to 5.5 V |
| V_I | Input voltage | -0.3 V to $V_{DD} + 0.3$ V |
| | Output Continuous total power dissipation | See Dissipation Rating Table |
| T_A | Operating free-air temperature range | -40°C to 85°C |
| T_J | Operating junction temperature range | -40°C to 150°C |
| T_{stg} | Storage temperature range | -65°C to 150°C |
| | Lead temperature 1,6 mm (1/16 inch) from case for 10 seconds | 260°C |

- (1) Stresses beyond those listed under *absolute maximum ratings* may cause permanent damage to the device. These are stress ratings only, and functional operation of the device at these or any other conditions beyond those indicated under *recommended operating conditions* is not implied. Exposure to absolute-maximum-rated conditions for extended periods may affect device reliability.

DISSIPATION RATINGS TABLE

| PACKAGE | $T_A \leq 25^\circ\text{C}$ POWER RATING | DERATING FACTOR ⁽¹⁾ | $T_A = 70^\circ\text{C}$ POWER RATING | $T_A = 85^\circ\text{C}$ POWER RATING |
|-------------------|---|--------------------------------|--|--|
| RTJ (TPA4411) | 5200 mW | 41.6 mW/°C | 3120 mW | 2700 mW |
| RTJ (TPA4411M) | 3450 mW | 34.5 mW/°C | 1898 mW | 1380 mW |
| YZH | 1200 mW | 9.21 mW/°C | 690 mW | 600 mW |

(1) Derating factor measured with High K board.

AVAILABLE OPTIONS

| T_A | PACKAGED DEVICES ⁽¹⁾ | PART NUMBER | SYMBOL |
|---------------|---------------------------------|----------------------------|--------|
| -40°C to 85°C | 20-pin, 4 mm × 4 mm QFN | TPA4411RTJ ⁽²⁾ | AKQ |
| | 20-pin, 4 mm × 4 mm QFN | TPA4411MRTJ ⁽²⁾ | BPB |
| | 16-ball, 2.18 mm × 2.18 mm WSCP | TPA4411YZH | AKT |

- (1) For the most current package and ordering information, see the Package Option Addendum at the end of this document, or see the TI website at www.ti.com.
- (2) The RTJ package is only available taped and reeled. To order, add the suffix "R" to the end of the part number for a reel of 3000, or add the suffix "T" to the end of the part number for a reel of 250 (e.g., TPA4411RTJR).

RECOMMENDED OPERATING CONDITIONS

| | MIN | MAX | UNIT |
|--------------------------------------|----------------------------------|--------------------|------|
| Supply voltage, AVDD, PVDD | 1.8 | 4.5 ⁽¹⁾ | V |
| V_{IH} High-level input voltage | $\overline{SDL}, \overline{SDR}$ | | V |
| V_{IL} Low-level input voltage | $\overline{SDL}, \overline{SDR}$ | | V |
| T_A Operating free-air temperature | -40 | 85 | °C |

(1) Device can shut down for $V_{DD} > 4.5$ V to prevent damage to the device.

ELECTRICAL CHARACTERISTICS

$T_A = 25^\circ\text{C}$ (unless otherwise noted)

| PARAMETER | TEST CONDITIONS | MIN | TYP | MAX | UNIT |
|--|---|-----|-----|------|---------------|
| VOS Output offset voltage | $V_{DD} = 1.8$ V to 4.5 V, Inputs grounded | | | 8 | mV |
| PSRR Power Supply Rejection Ratio | $V_{DD} = 1.8$ V to 4.5 V | -69 | -80 | | dB |
| V_{OH} High-level output voltage | $V_{DD} = 3$ V, $R_L = 16 \Omega$ | 2.2 | | | V |
| V_{OL} Low-level output voltage | $V_{DD} = 3$ V, $R_L = 16 \Omega$ | | | -1.1 | V |
| $ I_{IH} $ High-level input current ($\overline{SDL}, \overline{SDR}$) | $V_{DD} = 4.5$ V, $V_I = V_{DD}$ | | | 1 | μA |
| $ I_{IL} $ Low-level input current ($\overline{SDL}, \overline{SDR}$) | $V_{DD} = 4.5$ V, $V_I = 0$ V | | | 1 | μA |
| I_{DD} Supply Current | $V_{DD} = 1.8$ V, No load, $\overline{SDL} = \overline{SDR} = V_{DD}$ | | 5.3 | 6.5 | mA |
| | $V_{DD} = 3$ V, No load, $\overline{SDL} = \overline{SDR} = V_{DD}$ | | 6.5 | 8.0 | |
| | $V_{DD} = 4.5$ V, No load, $\overline{SDL} = \overline{SDR} = V_{DD}$ | | 8.0 | 10.0 | |
| | Shutdown mode, $V_{DD} = 1.8$ V to 4.5 V | | | | 1 |

OPERATING CHARACTERISTICS

 $V_{DD} = 3\text{ V}$, $T_A = 25^\circ\text{C}$, $R_L = 16\ \Omega$ (unless otherwise noted)

| PARAMETER | | TEST CONDITIONS | MIN | TYP | MAX | UNIT |
|--------------|--------------------------------------|---|-------|---------|-------|---------------------|
| P_O | Output power (Outputs In Phase) | THD = 1%, $V_{DD} = 3\text{ V}$, $f = 1\text{ kHz}$ | | 50 | | mW |
| | | THD = 1%, $V_{DD} = 4.5\text{ V}$, $f = 1\text{ kHz}$ | | 100 | | |
| | | THD = 1%, $V_{DD} = 3\text{ V}$, $f = 1\text{ kHz}$, $R_L = 32\ \Omega$ | | 50 | | |
| THD+N | Total harmonic distortion plus noise | $P_O = 25\text{ mW}$, $f = 1\text{ kHz}$ | | 0.054% | | |
| | | $P_O = 25\text{ mW}$, $f = 20\text{ kHz}$ | | 0.010% | | |
| | Crosstalk | $P_O = 20\text{ mW}$, $f = 1\text{ kHz}$ | | -83 | | dB |
| k_{SVR} | Supply ripple rejection ratio | 200-mV _{pp} ripple, $f = 217\text{ Hz}$ | | -82.5 | | dB |
| | | 200-mV _{pp} ripple, $f = 1\text{ kHz}$ | | -70.4 | | |
| | | 200-mV _{pp} ripple, $f = 20\text{ kHz}$ | | -45.1 | | |
| A_v | Closed-loop voltage gain | | -1.45 | -1.5 | -1.55 | V/V |
| ΔA_v | Gain matching | | | 1% | | |
| | Slew rate | | | 2.2 | | V/ μs |
| | Maximum capacitive load | | | 400 | | pF |
| V_n | Noise output voltage | | | 10 | | μV_{RMS} |
| | Electrostatic discharge, IEC | OUTR, OUTL | | ± 8 | | kV |
| f_{osc} | Charge pump switching frequency | | 280 | 320 | 420 | kHz |
| | Start-up time from shutdown | | | 450 | | μs |
| | Input impedance | | 12 | 15 | 18 | k Ω |
| SNR | Signal-to-noise ratio | $P_O = 40\text{ mW}$ (THD+N = 0.1%) | | 98 | | dB |
| | Thermal shutdown | Threshold | 150 | | 170 | $^\circ\text{C}$ |
| | | Hysteresis | | 15 | | $^\circ\text{C}$ |

Functional Block Diagram

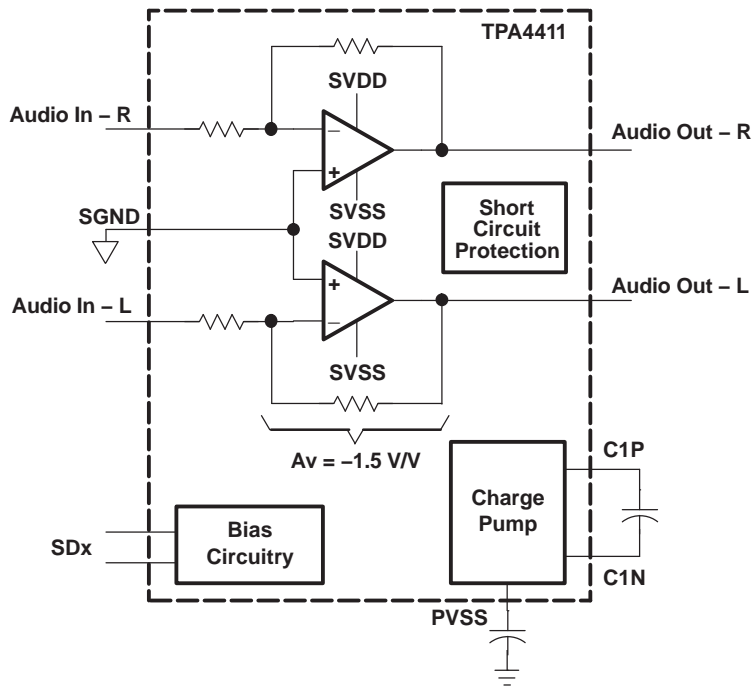

APPLICATION CIRCUIT

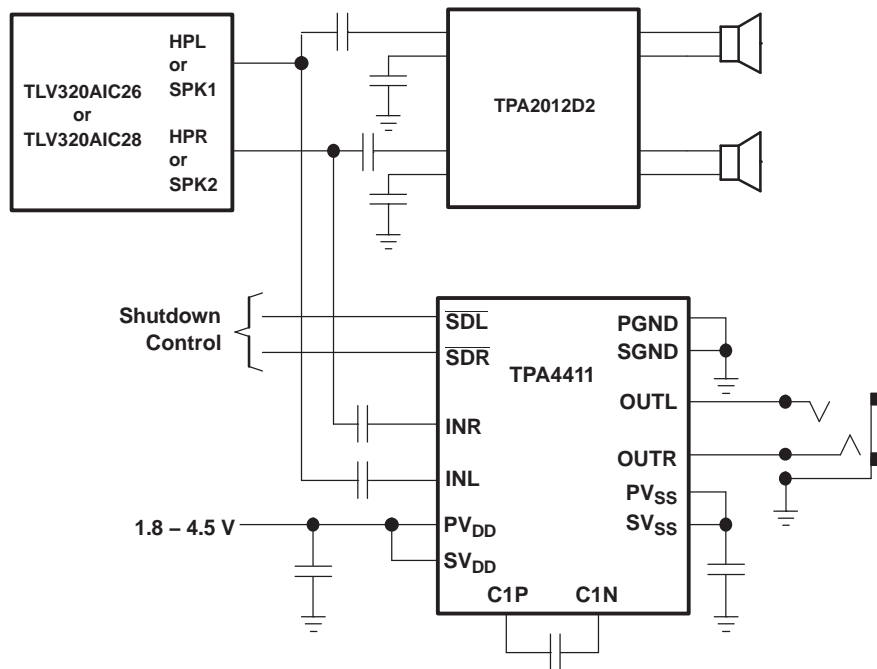

TYPICAL CHARACTERISTICS

$C_{(PUMP)} = C_{(PVSS)} = 2.2 \mu\text{F}$, $C_{IN} = 1 \mu\text{F}$ (unless otherwise noted)

Table of Graphs

| | | FIGURE |
|-----------------------------------|--------------------|---------------|
| Total harmonic distortion + noise | vs Output power | 1–24 |
| Total harmonic distortion + noise | vs Frequency | 25–32 |
| Supply voltage rejection ratio | vs Frequency | 33, 34 |
| Power dissipation | vs Output power | 35–42 |
| Crosstalk | vs Frequency | 43–46 |
| Output power | vs Supply voltage | 47–50 |
| Quiescent supply current | vs Supply voltage | 51 |
| Output power | vs Load resistance | 5–60 |
| Output spectrum | | 61 |
| Gain and phase | vs Frequency | 62, 63 |

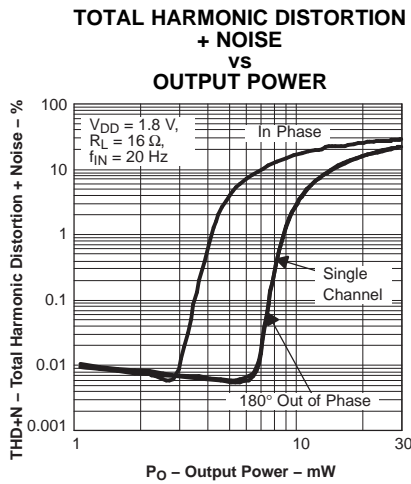

Figure 1.

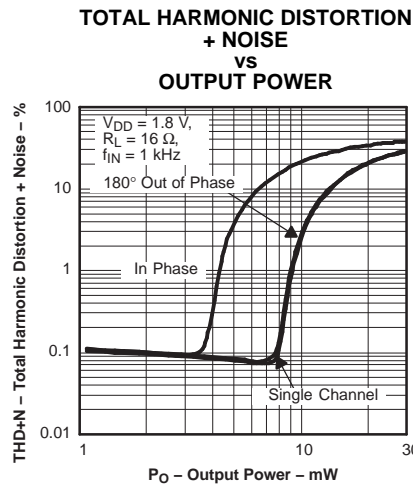

Figure 2.

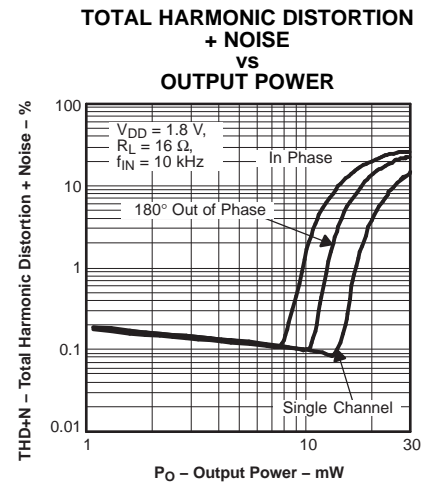

Figure 3.

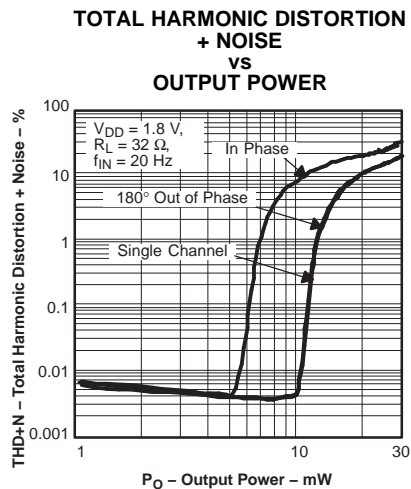

Figure 4.

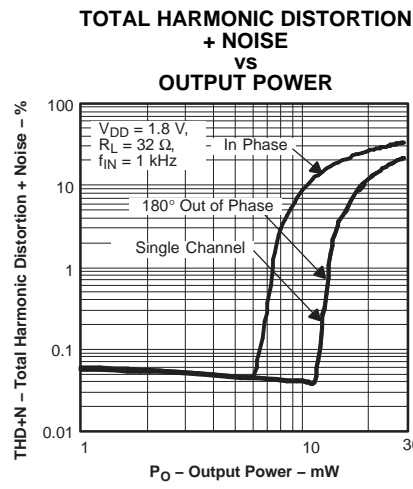

Figure 5.

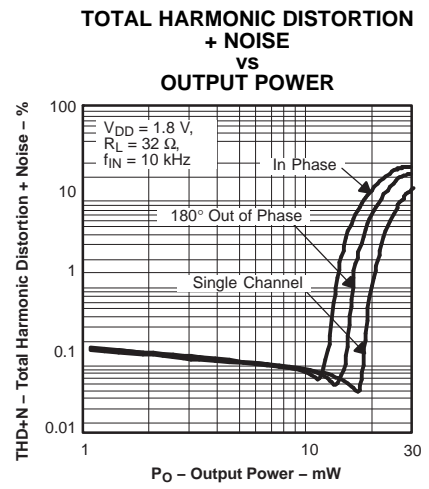

Figure 6.

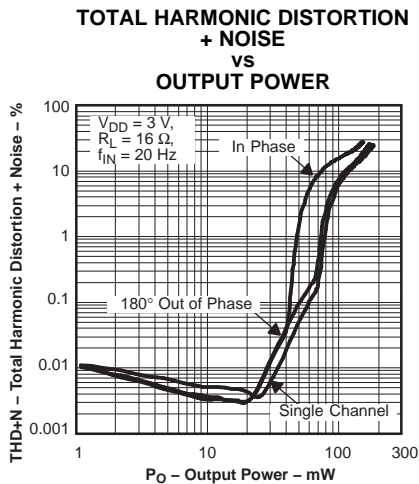

Figure 7.

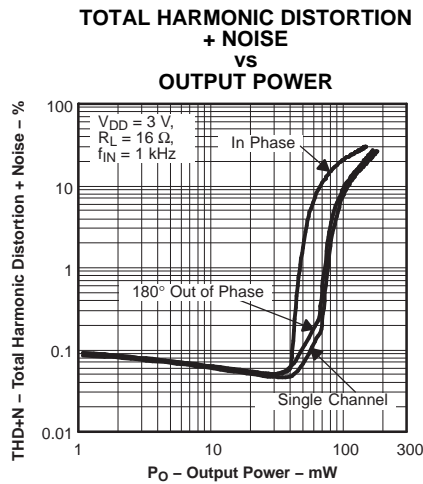

Figure 8.

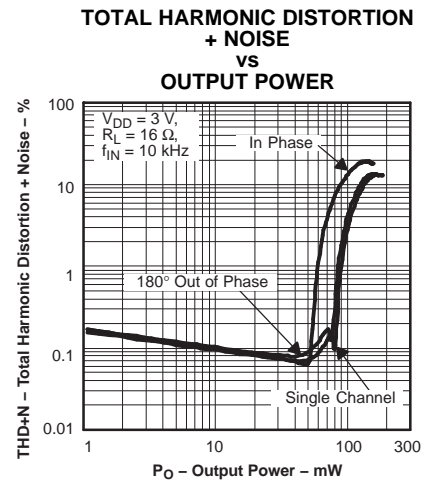

Figure 9.

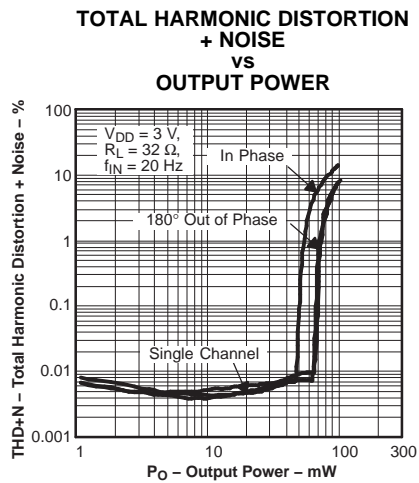

Figure 10.

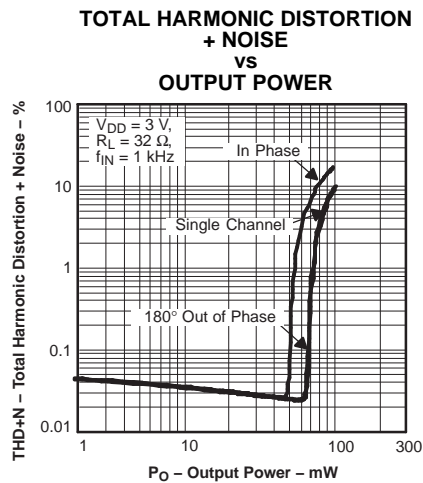

Figure 11.

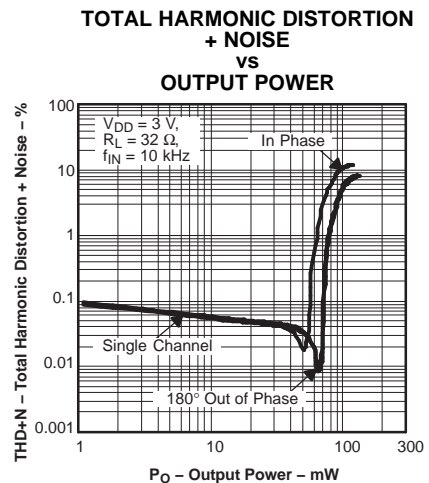

Figure 12.

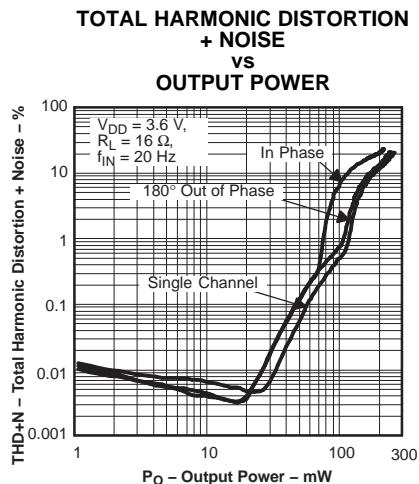

Figure 13.

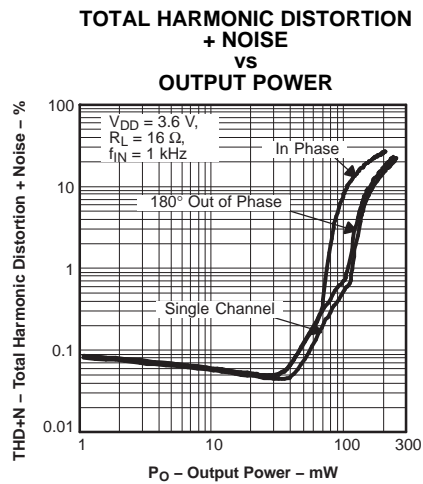

Figure 14.

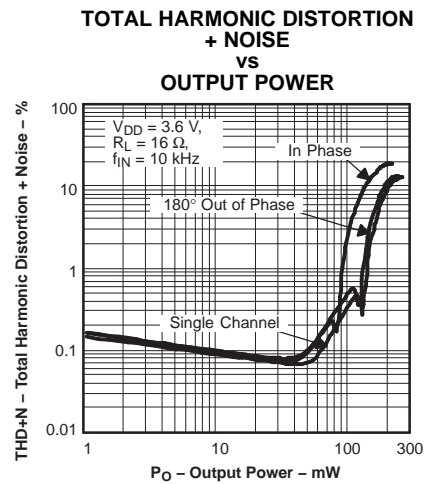

Figure 15.

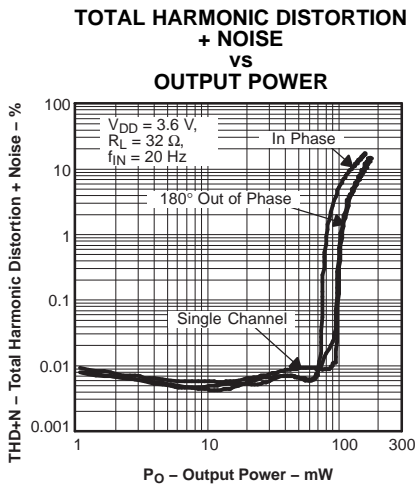

Figure 16.

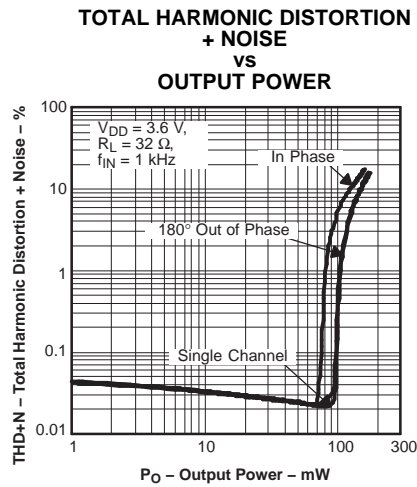

Figure 17.

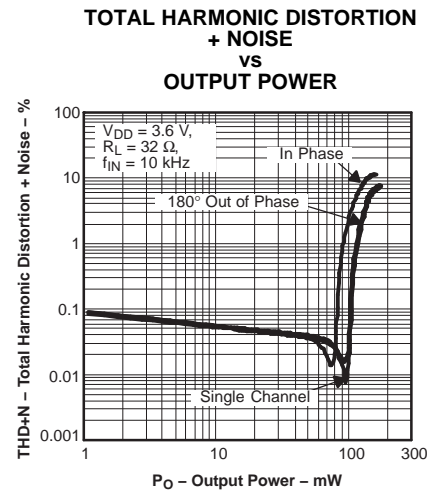

Figure 18.

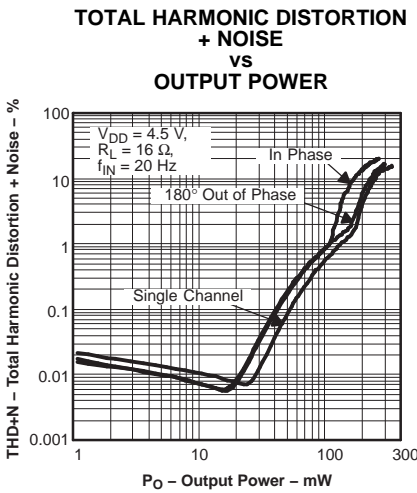

Figure 19.

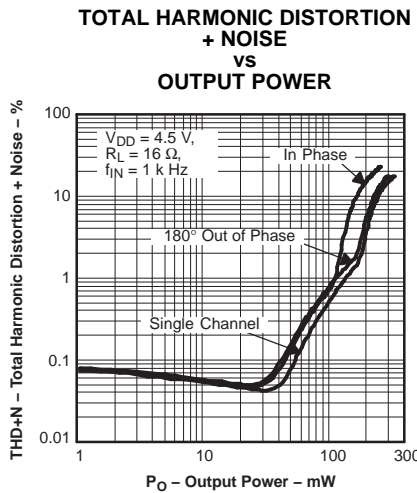

Figure 20.

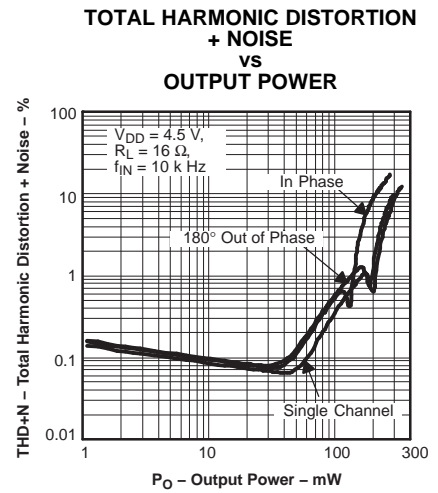

Figure 21.

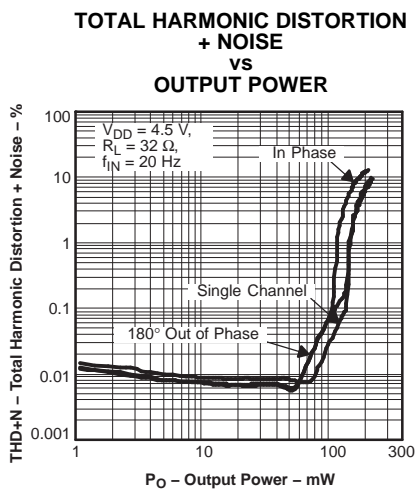

Figure 22.

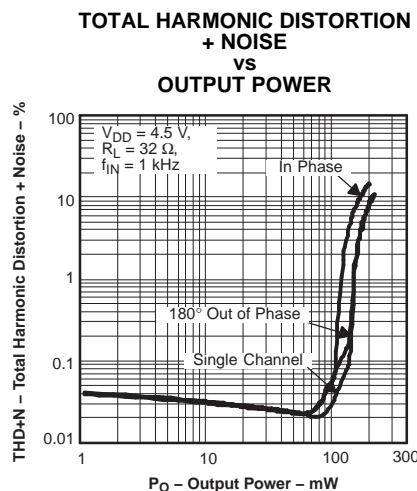

Figure 23.

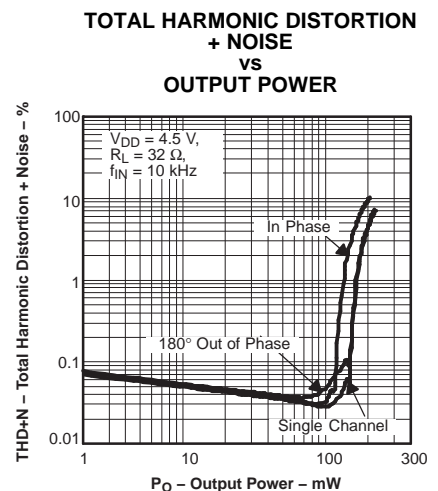

Figure 24.

TOTAL HARMONIC DISTORTION + NOISE VS FREQUENCY

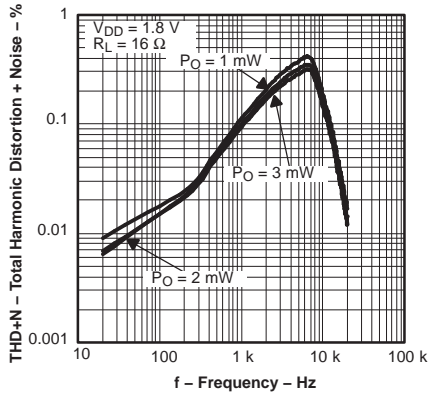

Figure 25.

TOTAL HARMONIC DISTORTION + NOISE VS FREQUENCY

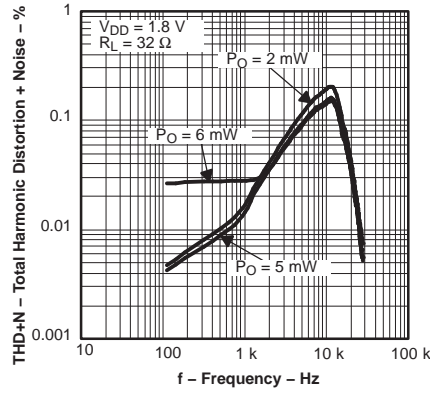

Figure 26.

TOTAL HARMONIC DISTORTION + NOISE VS FREQUENCY

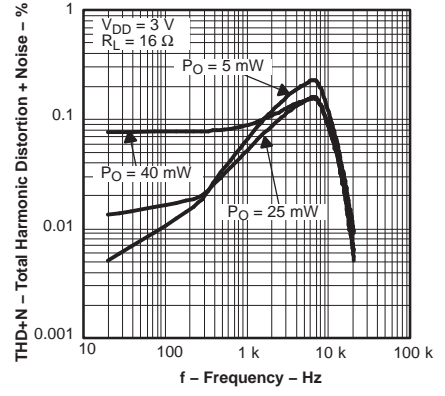

Figure 27.

TOTAL HARMONIC DISTORTION + NOISE VS FREQUENCY

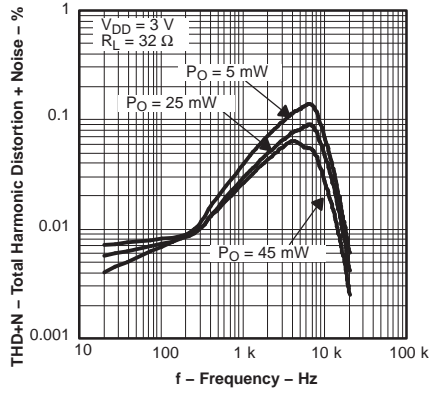

Figure 28.

TOTAL HARMONIC DISTORTION + NOISE VS FREQUENCY

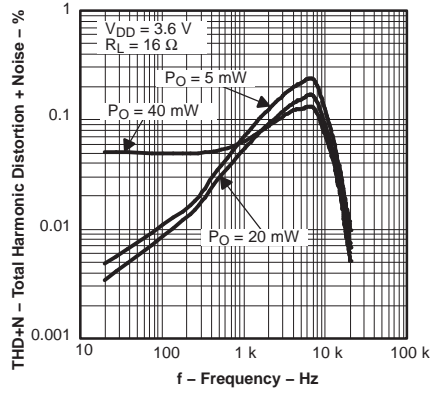

Figure 29.

TOTAL HARMONIC DISTORTION + NOISE VS FREQUENCY

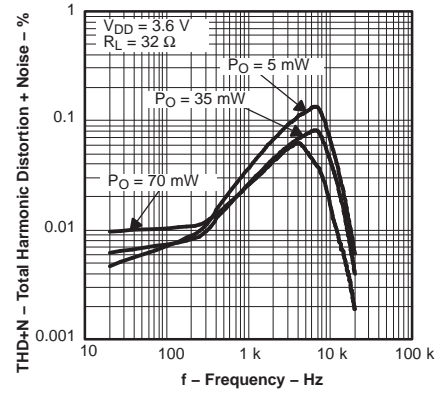

Figure 30.

TOTAL HARMONIC DISTORTION + NOISE VS FREQUENCY

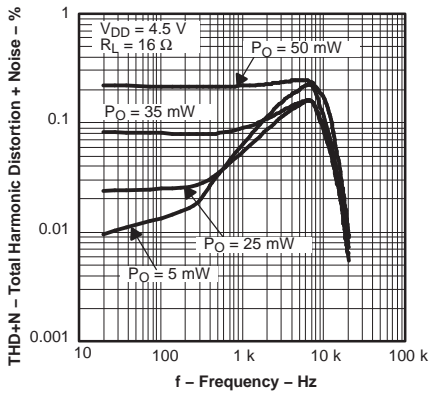

Figure 31.

TOTAL HARMONIC DISTORTION + NOISE VS FREQUENCY

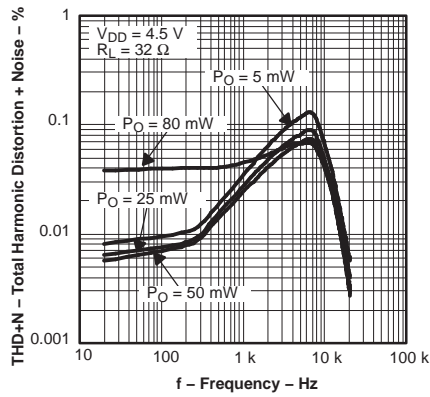

Figure 32.

SUPPLY VOLTAGE REJECTION RATIO VS FREQUENCY

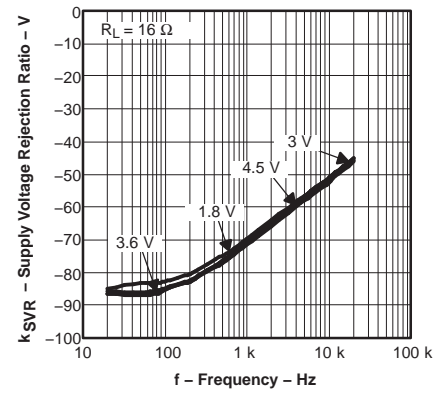

Figure 33.

SUPPLY VOLTAGE REJECTION RATIO VS FREQUENCY

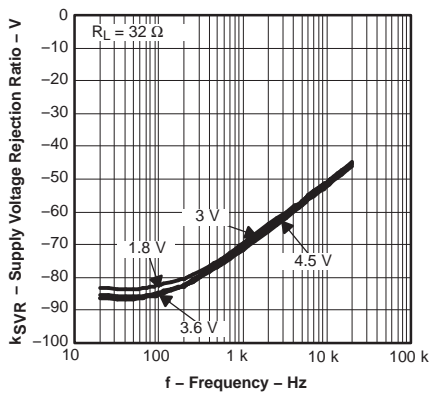

Figure 34.

POWER DISSIPATION VS OUTPUT POWER

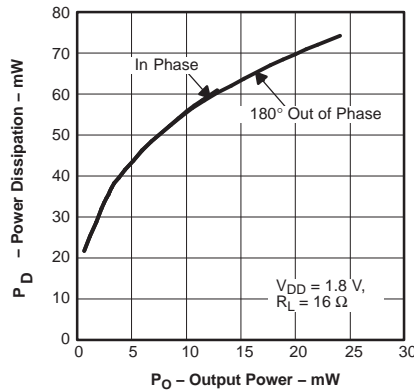

Figure 35.

POWER DISSIPATION VS OUTPUT POWER

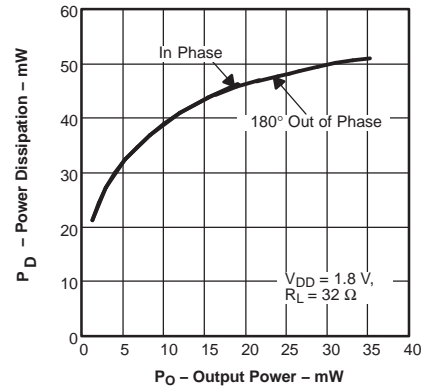

Figure 36.

POWER DISSIPATION VS OUTPUT POWER

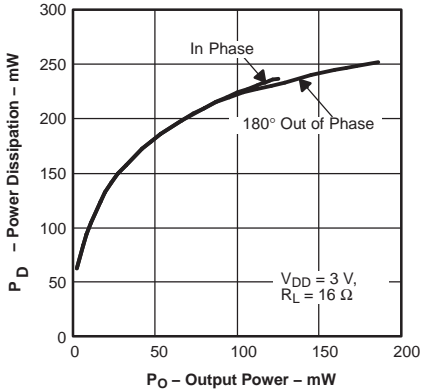

Figure 37.

POWER DISSIPATION VS OUTPUT POWER

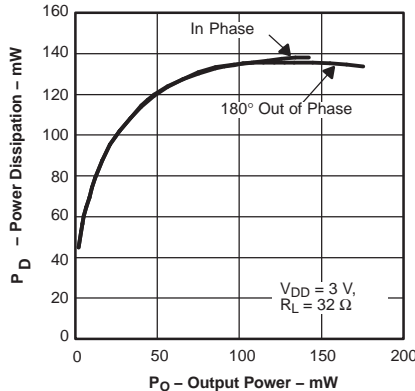

Figure 38.

POWER DISSIPATION VS OUTPUT POWER

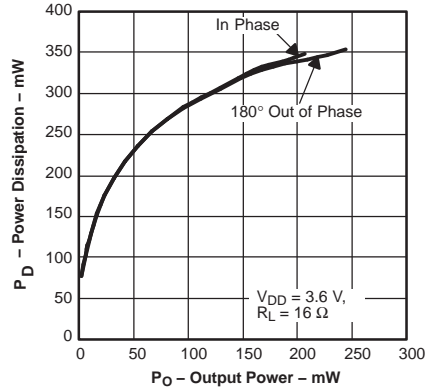

Figure 39.

POWER DISSIPATION VS OUTPUT POWER

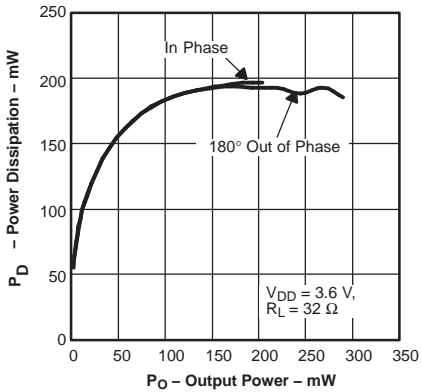

Figure 40.

POWER DISSIPATION VS OUTPUT POWER

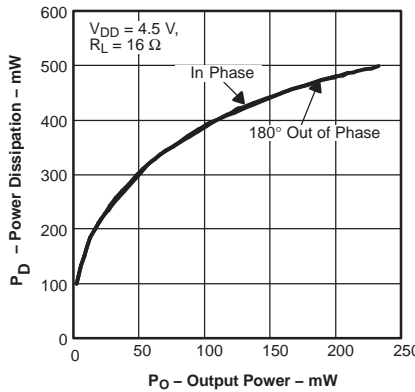

Figure 41.

POWER DISSIPATION VS OUTPUT POWER

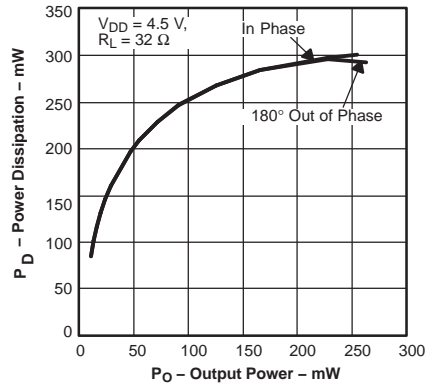

Figure 42.

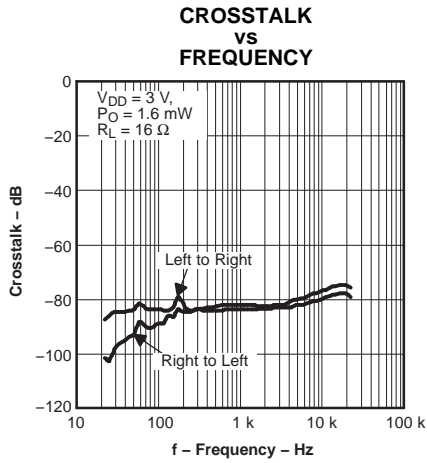

Figure 43.

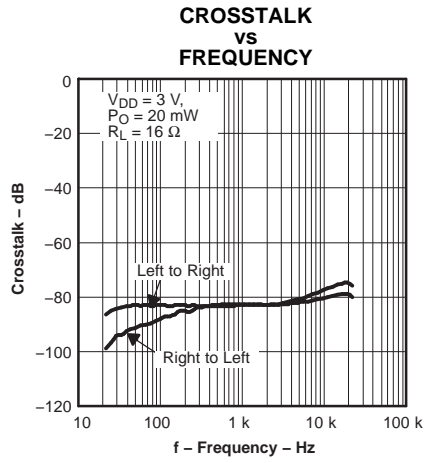

Figure 44.

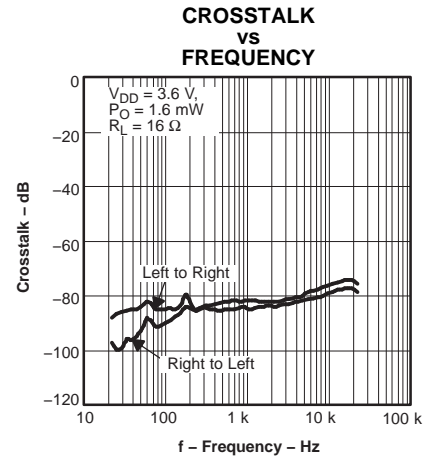

Figure 45.

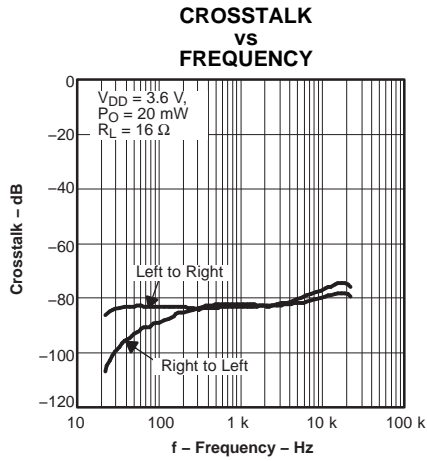

Figure 46.

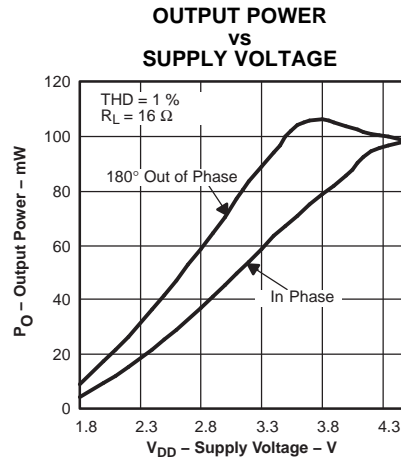

Figure 47.

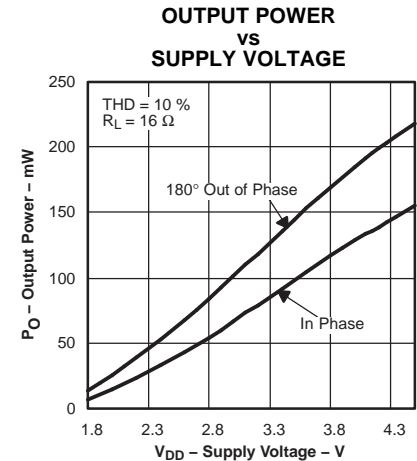

Figure 48.

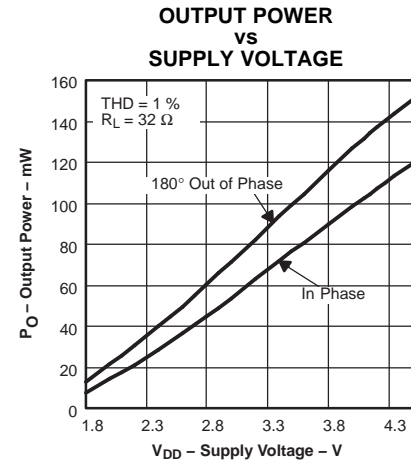

Figure 49.

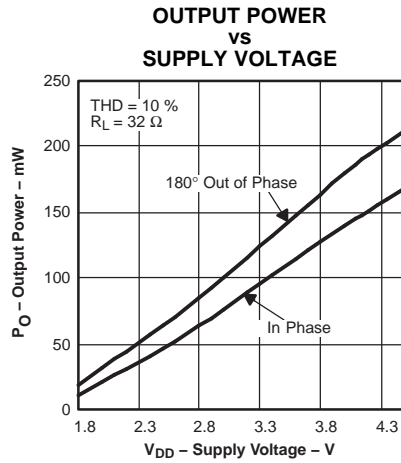

Figure 50.

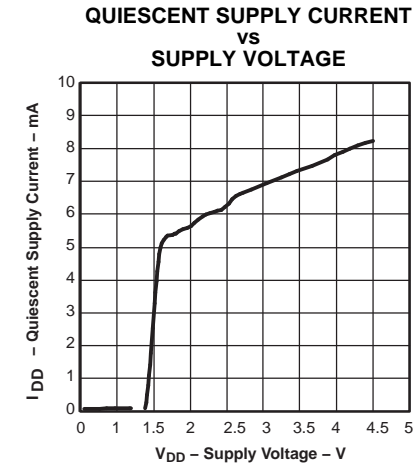

Figure 51.

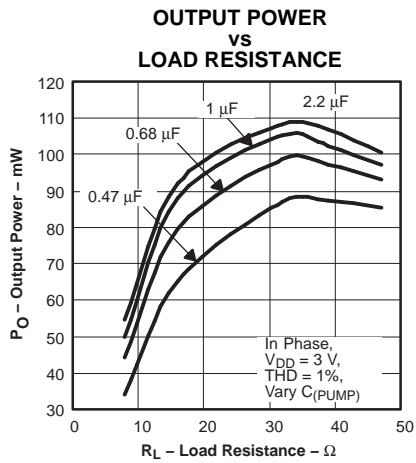

Figure 52.

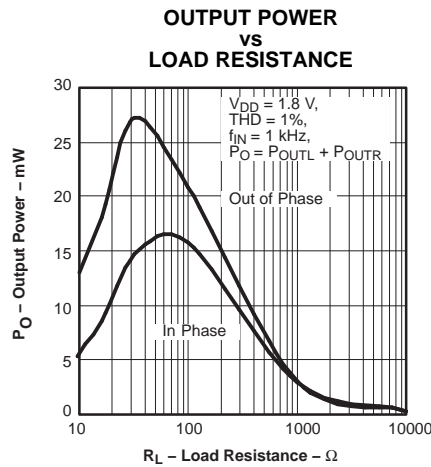

Figure 53.

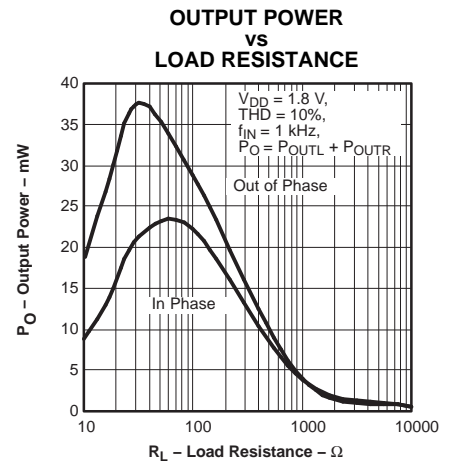

Figure 54.

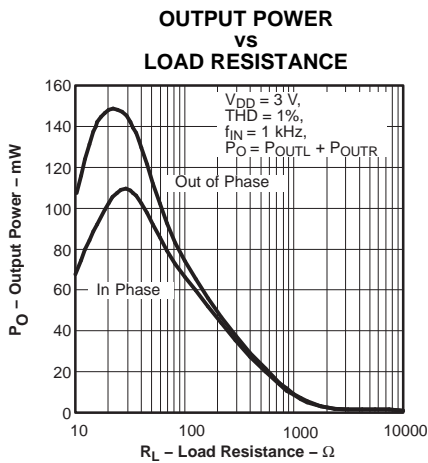

Figure 55.

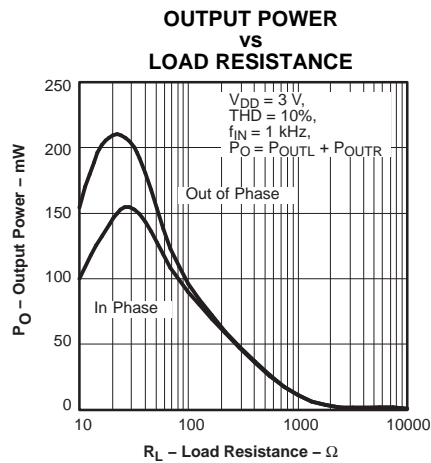

Figure 56.

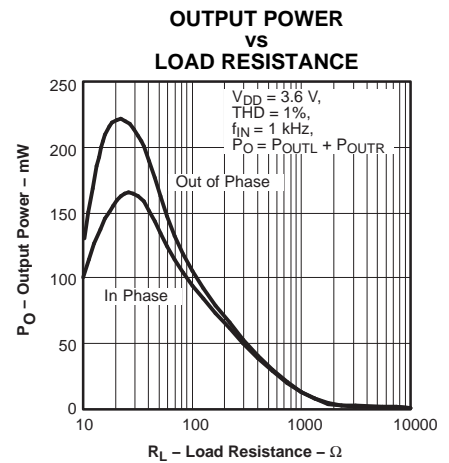

Figure 57.

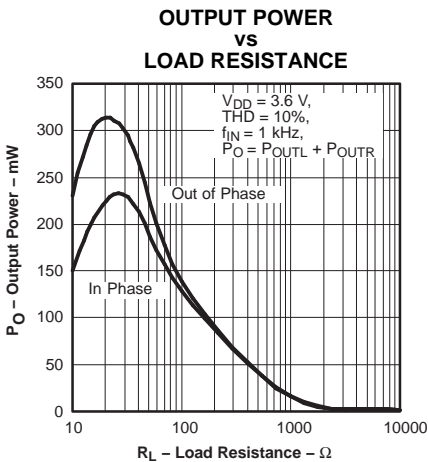

Figure 58.

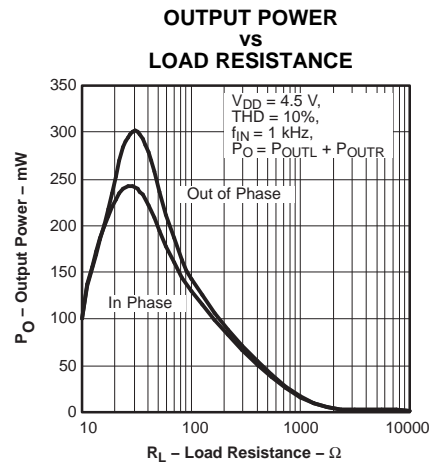

Figure 59.

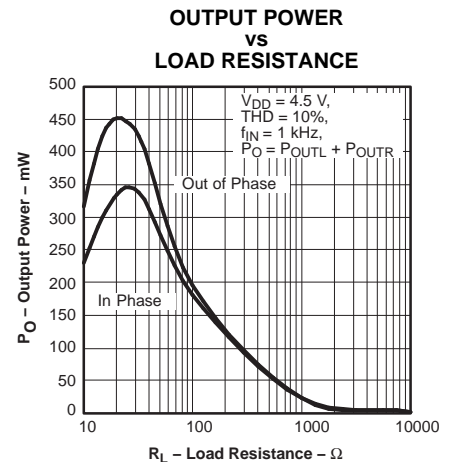

Figure 60.

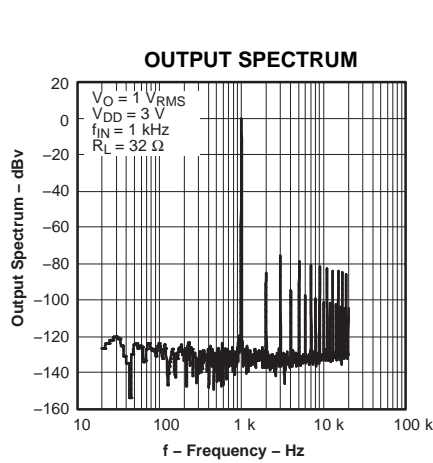

Figure 61.

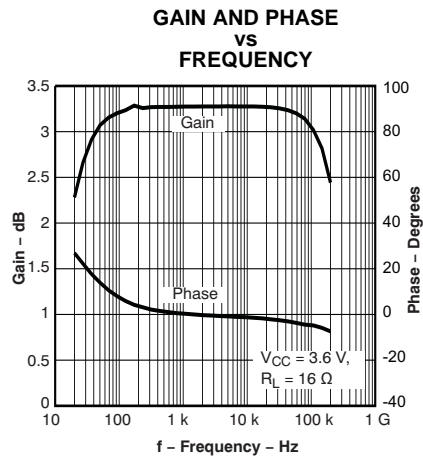

Figure 62.

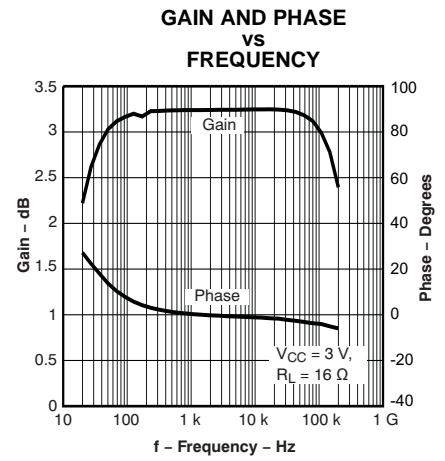

Figure 63.

APPLICATION INFORMATION

Headphone Amplifiers

Single-supply headphone amplifiers typically require dc-blocking capacitors. The capacitors are required because most headphone amplifiers have a dc bias on the outputs pin. If the dc bias is not removed, the output signal is severely clipped, and large amounts of dc current rush through the headphones, potentially damaging them. The top drawing in [Figure 64](#) illustrates the conventional headphone amplifier connection to the headphone jack and output signal.

DC blocking capacitors are often large in value. The headphone speakers (typical resistive values of 16 Ω or 32 Ω) combine with the dc blocking capacitors to form a high-pass filter. [Equation 1](#) shows the relationship between the load impedance (R_L), the capacitor (C_O), and the cutoff frequency (f_C).

$$f_C = \frac{1}{2\pi R_L C_O} \quad (1)$$

C_O can be determined using [Equation 2](#), where the load impedance and the cutoff frequency are known.

$$C_O = \frac{1}{2\pi R_L f_C} \quad (2)$$

If f_C is low, the capacitor must then have a large value because the load resistance is small. Large capacitance values require large package sizes. Large package sizes consume PCB area, stand high above the PCB, increase cost of assembly, and can reduce the fidelity of the audio output signal.

Two different headphone amplifier applications are available that allow for the removal of the output dc blocking capacitors. The Capless amplifier architecture is implemented in the same manner as the conventional amplifier with the exception of the headphone jack shield pin. This amplifier provides a reference voltage, which is connected to the headphone jack shield pin. This is the voltage on which the audio output signals are centered. This voltage reference is half of the amplifier power supply to allow symmetrical swing of the output voltages. Do not connect the shield to any GND reference or large currents will result. The scenario can happen if, for example, an accessory other than a floating GND headphone is plugged into the headphone connector. See the second block diagram and waveform in [Figure 64](#).

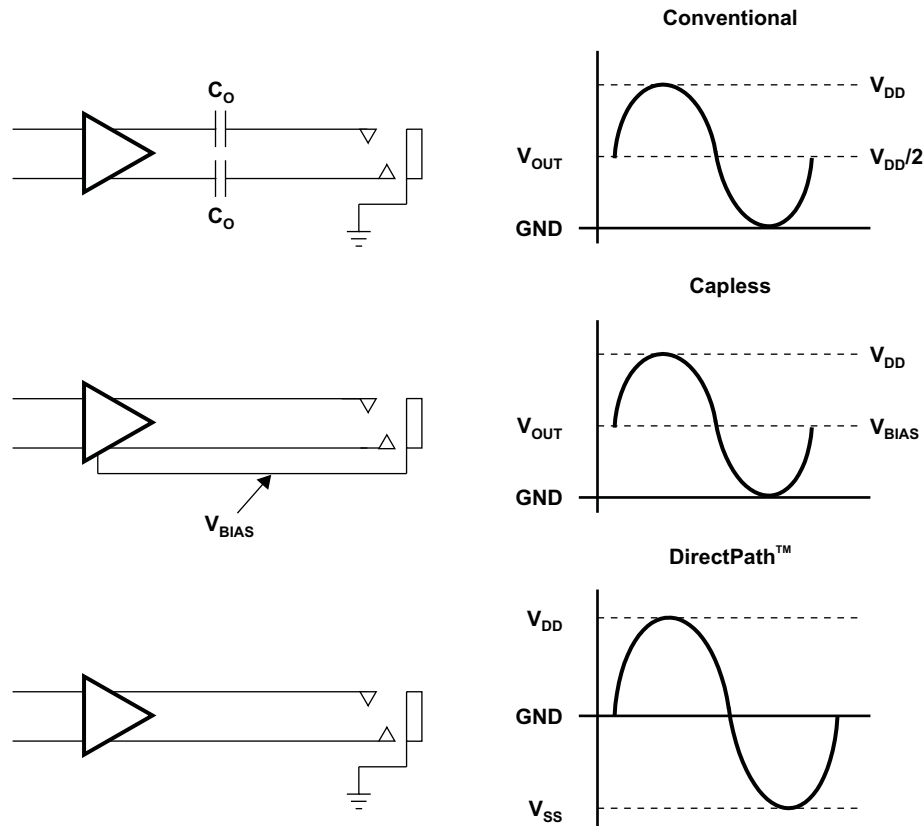

Figure 64. Amplifier Applications

The DirectPath™ amplifier architecture operates from a single supply but makes use of an internal charge pump to provide a negative voltage rail. Combining the user provided positive rail and the negative rail generated by the IC, the device operates in what is effectively a split supply mode. The output voltages are now centered at zero volts with the capability to swing to the positive rail or negative rail. The DirectPath™ amplifier requires no output dc blocking capacitors, and does not place any voltage on the sleeve. The bottom block diagram and waveform of Figure 64 illustrate the ground-referenced headphone architecture. This is the architecture of the TPA4411.

Input-Blocking Capacitors

DC input-blocking capacitors are required to be added in series with the audio signal into the input pins of the TPA4411 and TPA4411M. These capacitors block the DC portion of the audio source and allow the TPA4411 and TPA4411M inputs to be properly biased to provide maximum performance.

These capacitors form a high-pass filter with the input impedance of the TPA4411 and TPA4411M. The cutoff frequency is calculated using Equation 3. For this calculation, the capacitance used is the input-blocking capacitor and the resistance is the input impedance of the TPA4411 or TPA4411M. Because the gains of both the TPA4411 and TPA4411M are fixed, the input impedance remains a constant value. Using the input impedance value from the operating characteristics table, the frequency and/or capacitance can be determined when one of the two values are given.

$$f_{C_{IN}} = \frac{1}{2\pi R_{IN} C_{IN}} \quad \text{or} \quad C_{IN} = \frac{1}{2\pi f_{C_{IN}} R_{IN}} \quad (3)$$

Charge Pump Flying Capacitor and PVSS Capacitor

The charge pump flying capacitor serves to transfer charge during the generation of the negative supply voltage. The PVSS capacitor must be at least equal to the charge pump capacitor in order to allow maximum charge transfer. Low ESR capacitors are an ideal selection, and a value of 2.2 μF is typical. Capacitor values that are smaller than 2.2 μF can be used, but the maximum output power is reduced and the device may not operate to specifications. Figure 65 through Figure 75 compare the performance of the TPA4411 and TPA4411M with the recommended 2.2- μF capacitors and 1- μF capacitors.

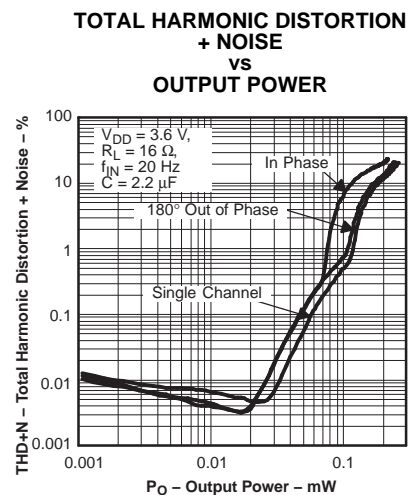
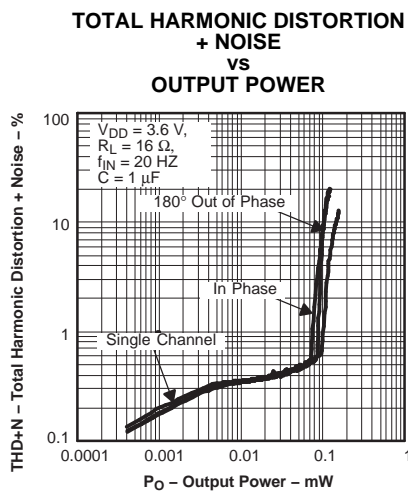
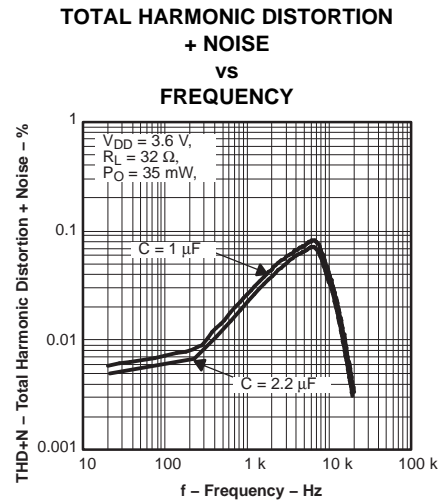

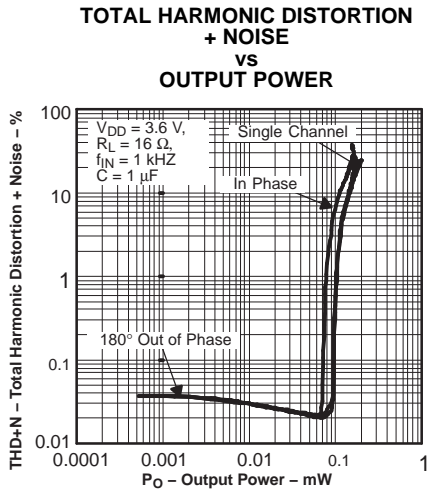

Figure 68.

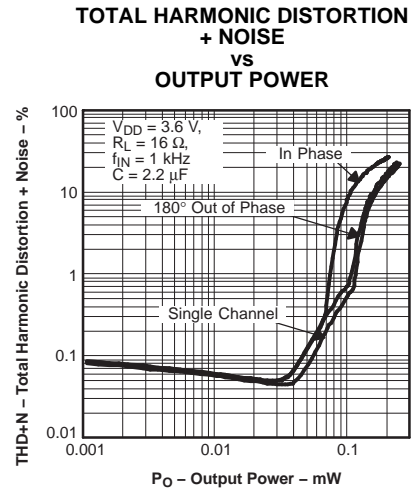

Figure 69.

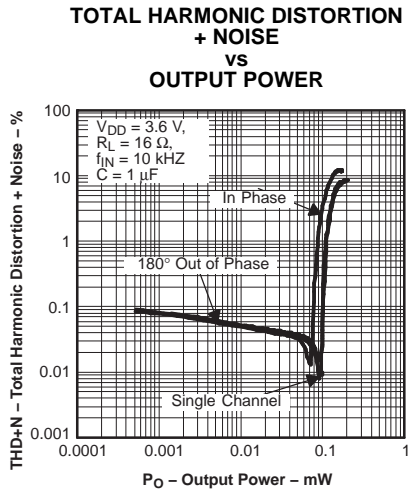

Figure 70.

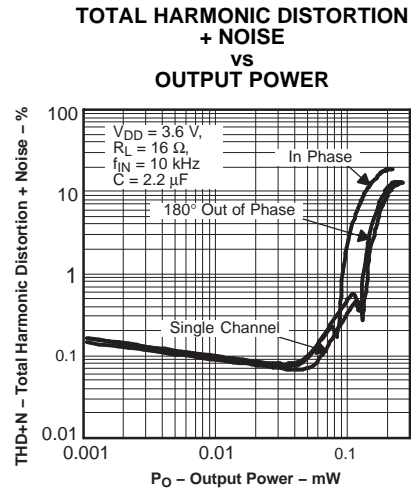

Figure 71.

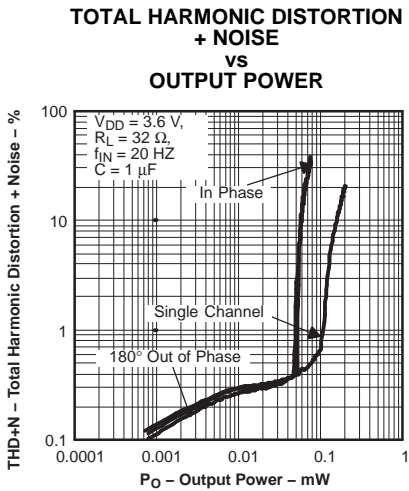

Figure 72.

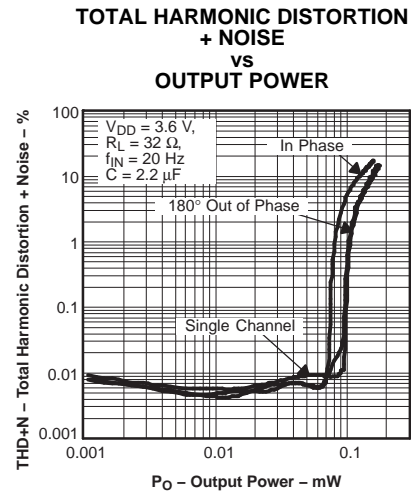

Figure 73.

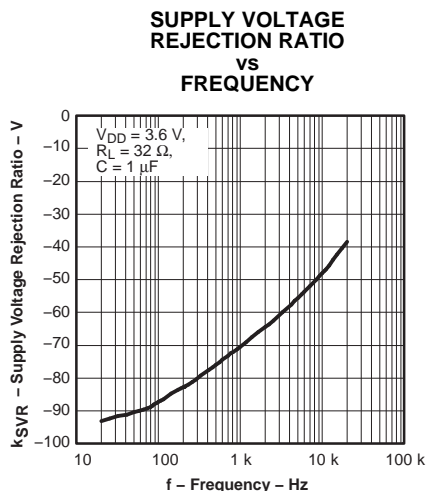

Figure 74.

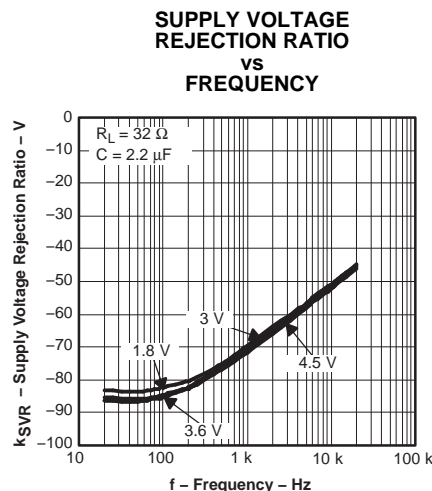

Figure 75.

Decoupling Capacitors

The TPA4411 and TPA4411M are DirectPath™ headphone amplifiers that require adequate power supply decoupling to ensure that the noise and total harmonic distortion (THD) are low. A good low equivalent-series-resistance (ESR) ceramic capacitor, typically 2.2 μF , placed as close as possible to the device V_{DD} lead works best. Placing this decoupling capacitor close to the TPA4411 or TPA4411M is important for the performance of the amplifier. For filtering lower frequency noise signals, a 10- μF or greater capacitor placed near the audio power amplifier would also help, but it is not required in most applications because of the high PSRR of this device.

Supply Voltage Limiting At 4.5 V

The TPA4411 and TPA4411M have a built-in charge pump which serves to generate a negative rail for the headphone amplifier. Because the headphone amplifier operates from a positive voltage and negative voltage supply, circuitry has been implemented to protect the devices in the amplifier from an overvoltage condition. Once the supply is above 4.5 V, the TPA4411 and TPA4411M can shut down in an overvoltage protection mode to prevent damage to the device. The TPA4411 and TPA4411M resume normal operation once the supply is reduced to 4.5 V or lower.

Layout Recommendations

Exposed Pad On TPA4411RTJ and TPA4411MRTJ Package Option

The exposed metal pad on the TPA4411RTJ and TPA4411MRTJ packages must be soldered down to a pad on the PCB in order to maintain reliability. *The pad on the PCB should be allowed to float and not be connected to ground or power.* Connecting this pad to power or ground prevents the device from working properly because it is connected internally to PVSS.

TPA4411RTJ and TPA441MRTJ PowerPAD Sizes

Both the TPA4411 and TPA4411M are available in a 4 mm \times 4mm QFN. The exposed pad on the bottom of the package is sized differently between the two devices. The TPA4411RTJ PowerPAD is larger than the TPA4411MRTJ PowerPAD. Please see the layout and mechanical drawings at the end of the datasheet for proper sizing.

SGND and PGND Connections

The SGND and PGND pins of the TPA4411 and TPA4411M must be routed separately back to the decoupling capacitor in order to provide proper device operation. If the SGND and PGND pins are connected directly to each other, the part functions without risk of failure, but the noise and THD performance do not meet the specifications.

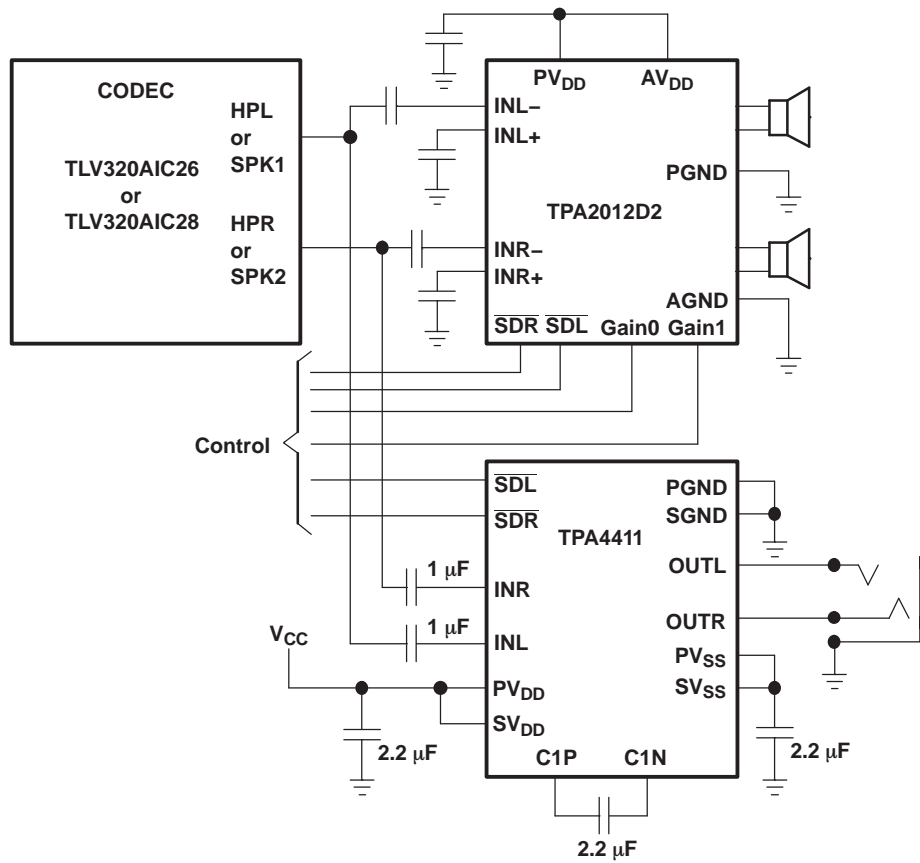
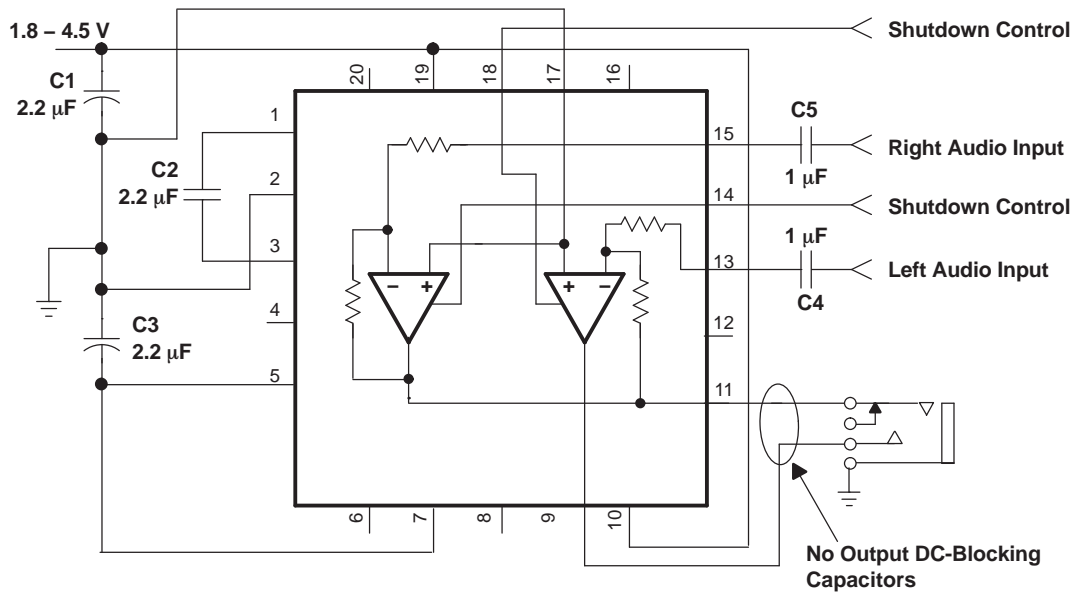

Figure 76. Application Circuit



Note: PowerPAD must be soldered down and plane must be floating.

Figure 77. Typical Circuit

TPA4411RTJ

RTJ (S-PQFP-N20)

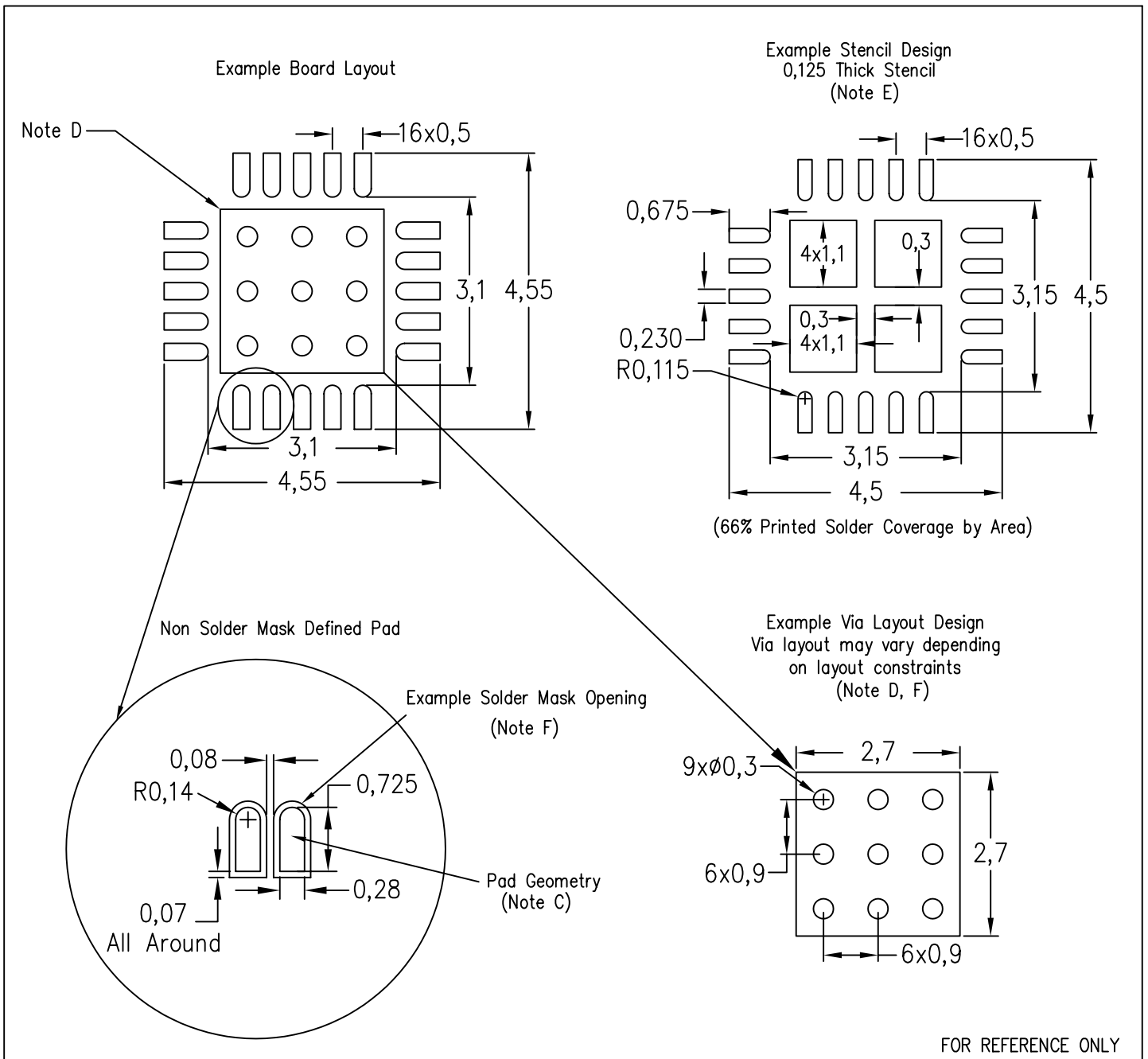

- NOTES:
- All linear dimensions are in millimeters.
 - This drawing is subject to change without notice.
 - Publication IPC-SM-782 is recommended for alternate designs.
 - This package is designed to be soldered to a thermal pad on the board. Refer to Application Note, Quad Flat-Pack Packages, Texas Instruments Literature No. SCBA017, SLUA271, and also the Product Data Sheets for specific thermal information, via requirements, and recommended board layout. These documents are available at www.ti.com <<http://www.ti.com>>.
 - Laser cutting apertures with trapezoidal walls and also rounding corners will offer better paste release. Customers should contact their board assembly site for stencil design recommendations. Refer to IPC 7525 for stencil design considerations.
 - Customers should contact their board fabrication site for recommended solder mask tolerances and via tenting recommendations for vias placed in the thermal pad.

TPA4411MRTJ

RTJ (S-PQFP-N20)

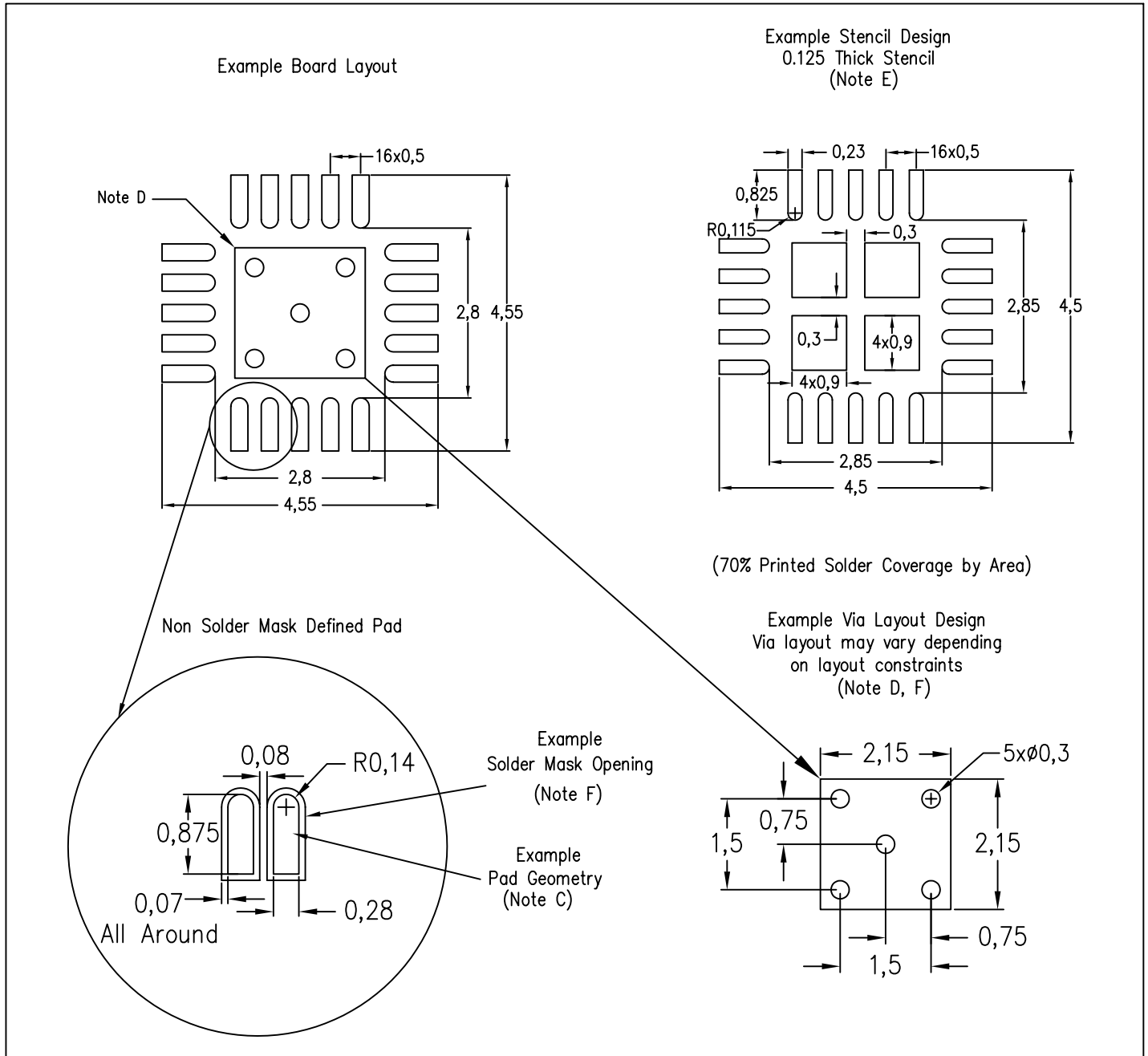

- NOTES:
- A. All linear dimensions are in millimeters.
 - B. This drawing is subject to change without notice.
 - C. Publication IPC-SM-782 is recommended for alternate designs.
 - D. This package is designed to be soldered to a thermal pad on the board. Refer to Application Note, Quad Flat-Pack Packages, Texas Instruments Literature No. SCBA017, SLUA271, and also the Product Data Sheets for specific thermal information, via requirements, and recommended board layout. These documents are available at www.ti.com <<http://www.ti.com>>.
 - E. Laser cutting apertures with trapezoidal walls and also rounding corners will offer better paste release. Customers should contact their board assembly site for stencil design recommendations. Refer to IPC 7525 for stencil design considerations.
 - F. Customers should contact their board fabrication site for recommended solder mask tolerances and via tenting recommendations for vias placed in the thermal pad.

PACKAGING INFORMATION

| Orderable Device | Status (1) | Package Type | Package Drawing | Pins | Package Qty | Eco Plan (2) | Lead finish/ Ball material (6) | MSL Peak Temp (3) | Op Temp (°C) | Device Marking (4/5) | Samples |
|------------------|---------------|--------------|-----------------|------|-------------|-----------------|--------------------------------------|----------------------|--------------|-------------------------|-------------------------|
| TPA4411MRTJR | ACTIVE | QFN | RTJ | 20 | 3000 | RoHS & Green | NIPDAU | Level-2-260C-1 YEAR | -40 to 85 | BPB | Samples |
| TPA4411MRTJRG4 | ACTIVE | QFN | RTJ | 20 | 3000 | TBD | Call TI | Call TI | -40 to 85 | | Samples |
| TPA4411MRTJT | ACTIVE | QFN | RTJ | 20 | 250 | RoHS & Green | NIPDAU | Level-2-260C-1 YEAR | -40 to 85 | BPB | Samples |
| TPA4411RTJR | ACTIVE | QFN | RTJ | 20 | 3000 | RoHS & Green | NIPDAU | Level-2-260C-1 YEAR | -40 to 85 | AKQ | Samples |
| TPA4411RTJRG4 | ACTIVE | QFN | RTJ | 20 | 3000 | TBD | Call TI | Call TI | -40 to 85 | | Samples |
| TPA4411RTJT | ACTIVE | QFN | RTJ | 20 | 250 | RoHS & Green | NIPDAU | Level-2-260C-1 YEAR | -40 to 85 | AKQ | Samples |
| TPA4411YZHR | ACTIVE | DSBGA | YZH | 16 | 3000 | RoHS & Green | SNAGCU | Level-1-260C-UNLIM | -40 to 85 | AKT | Samples |
| TPA4411YZHT | ACTIVE | DSBGA | YZH | 16 | 250 | RoHS & Green | SNAGCU | Level-1-260C-UNLIM | -40 to 85 | AKT | Samples |

(1) The marketing status values are defined as follows:

ACTIVE: Product device recommended for new designs.

LIFEBUY: TI has announced that the device will be discontinued, and a lifetime-buy period is in effect.

NRND: Not recommended for new designs. Device is in production to support existing customers, but TI does not recommend using this part in a new design.

PREVIEW: Device has been announced but is not in production. Samples may or may not be available.

OBSOLETE: TI has discontinued the production of the device.

(2) **RoHS:** TI defines "RoHS" to mean semiconductor products that are compliant with the current EU RoHS requirements for all 10 RoHS substances, including the requirement that RoHS substance do not exceed 0.1% by weight in homogeneous materials. Where designed to be soldered at high temperatures, "RoHS" products are suitable for use in specified lead-free processes. TI may reference these types of products as "Pb-Free".

RoHS Exempt: TI defines "RoHS Exempt" to mean products that contain lead but are compliant with EU RoHS pursuant to a specific EU RoHS exemption.

Green: TI defines "Green" to mean the content of Chlorine (Cl) and Bromine (Br) based flame retardants meet JS709B low halogen requirements of <=1000ppm threshold. Antimony trioxide based flame retardants must also meet the <=1000ppm threshold requirement.

(3) MSL, Peak Temp. - The Moisture Sensitivity Level rating according to the JEDEC industry standard classifications, and peak solder temperature.

(4) There may be additional marking, which relates to the logo, the lot trace code information, or the environmental category on the device.

(5) Multiple Device Markings will be inside parentheses. Only one Device Marking contained in parentheses and separated by a "~" will appear on a device. If a line is indented then it is a continuation of the previous line and the two combined represent the entire Device Marking for that device.

⁽⁶⁾ Lead finish/Ball material - Orderable Devices may have multiple material finish options. Finish options are separated by a vertical ruled line. Lead finish/Ball material values may wrap to two lines if the finish value exceeds the maximum column width.

Important Information and Disclaimer:The information provided on this page represents TI's knowledge and belief as of the date that it is provided. TI bases its knowledge and belief on information provided by third parties, and makes no representation or warranty as to the accuracy of such information. Efforts are underway to better integrate information from third parties. TI has taken and continues to take reasonable steps to provide representative and accurate information but may not have conducted destructive testing or chemical analysis on incoming materials and chemicals. TI and TI suppliers consider certain information to be proprietary, and thus CAS numbers and other limited information may not be available for release.

In no event shall TI's liability arising out of such information exceed the total purchase price of the TI part(s) at issue in this document sold by TI to Customer on an annual basis.

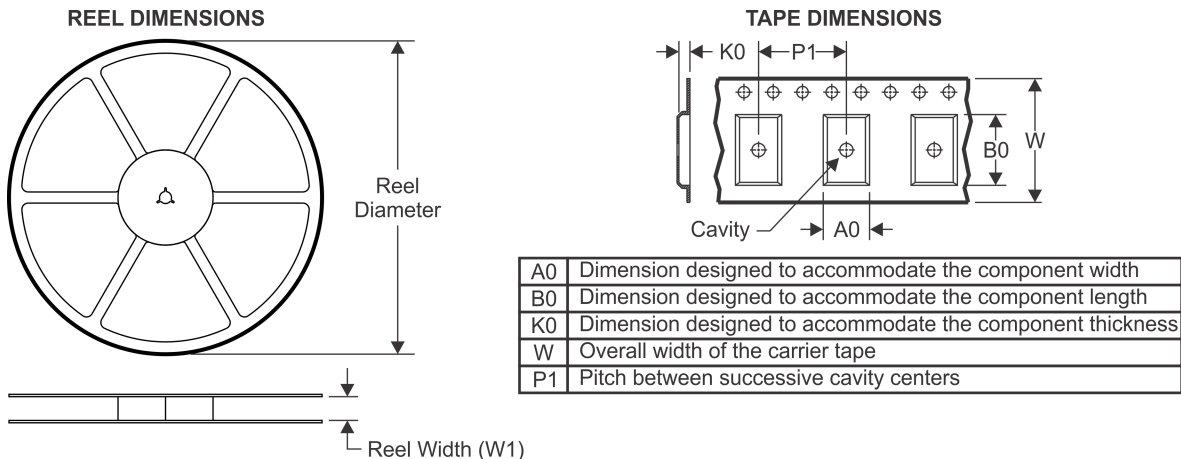
TAPE AND REEL INFORMATION

QUADRANT ASSIGNMENTS FOR PIN 1 ORIENTATION IN TAPE

*All dimensions are nominal

| Device | Package Type | Package Drawing | Pins | SPQ | Reel Diameter (mm) | Reel Width W1 (mm) | A0 (mm) | B0 (mm) | K0 (mm) | P1 (mm) | W (mm) | Pin1 Quadrant |
|-------------|--------------|-----------------|------|------|--------------------|--------------------|---------|---------|---------|---------|--------|---------------|
| TPA4411YZHR | DSBGA | YZH | 16 | 3000 | 180.0 | 8.4 | 2.38 | 2.4 | 0.8 | 4.0 | 8.0 | Q1 |
| TPA4411YZHT | DSBGA | YZH | 16 | 250 | 180.0 | 8.4 | 2.38 | 2.4 | 0.8 | 4.0 | 8.0 | Q1 |

TAPE AND REEL BOX DIMENSIONS

*All dimensions are nominal

| Device | Package Type | Package Drawing | Pins | SPQ | Length (mm) | Width (mm) | Height (mm) |
|-------------|--------------|-----------------|------|------|-------------|------------|-------------|
| TPA4411YZHR | DSBGA | YZH | 16 | 3000 | 182.0 | 182.0 | 20.0 |
| TPA4411YZHT | DSBGA | YZH | 16 | 250 | 182.0 | 182.0 | 20.0 |

YZH0016

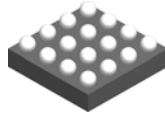

PACKAGE OUTLINE

DSBGA - 0.625 mm max height

DIE SIZE BALL GRID ARRAY

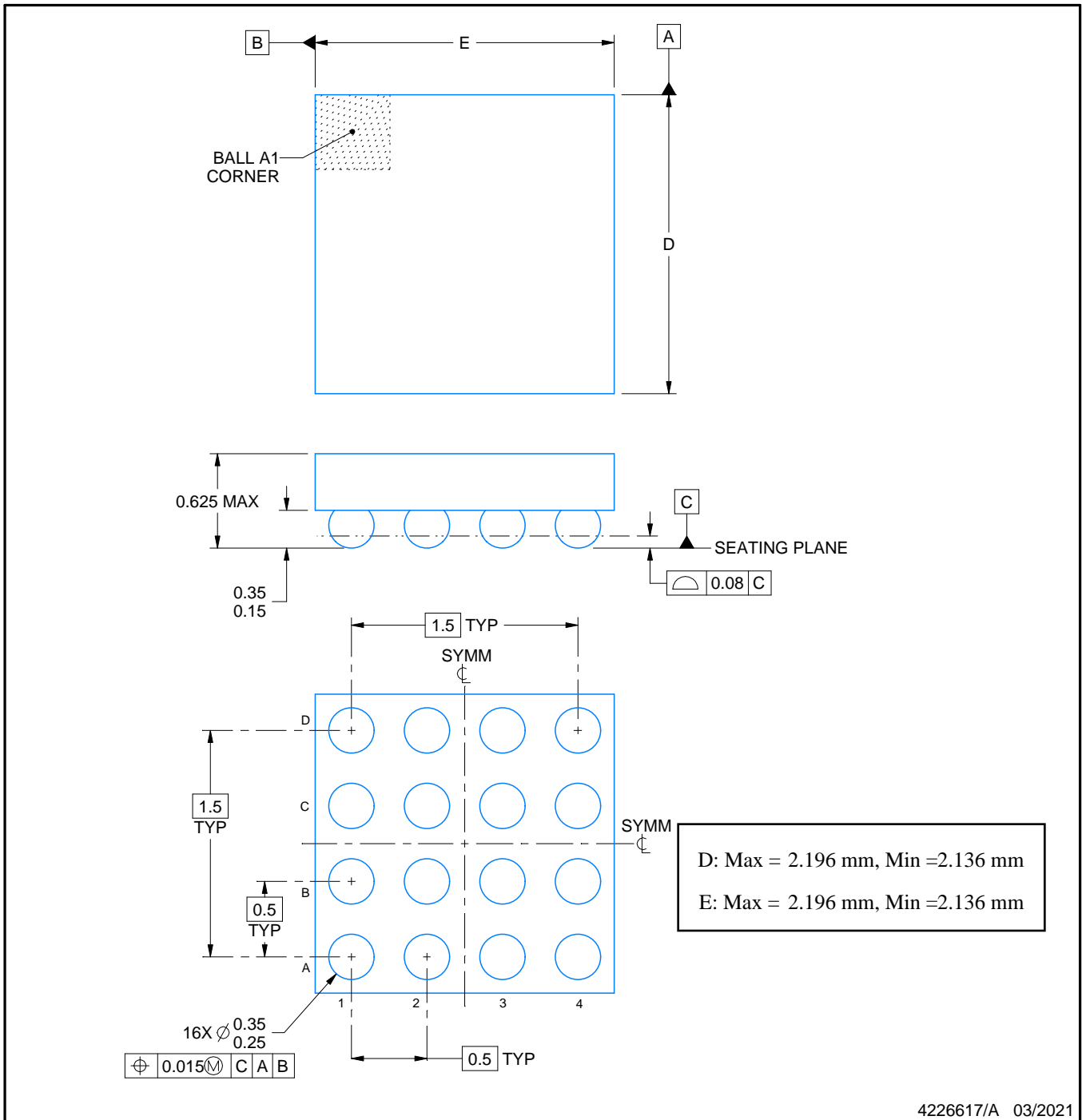

NOTES:

1. All linear dimensions are in millimeters. Any dimensions in parenthesis are for reference only. Dimensioning and tolerancing per ASME Y14.5M.
2. This drawing is subject to change without notice.

EXAMPLE BOARD LAYOUT

YZH0016

DSBGA - 0.625 mm max height

DIE SIZE BALL GRID ARRAY

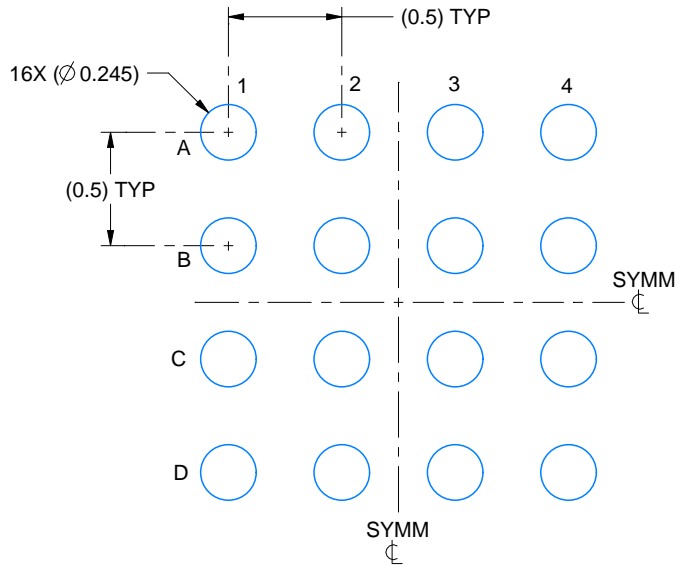

LAND PATTERN EXAMPLE
EXPOSED METAL SHOWN
SCALE: 30X

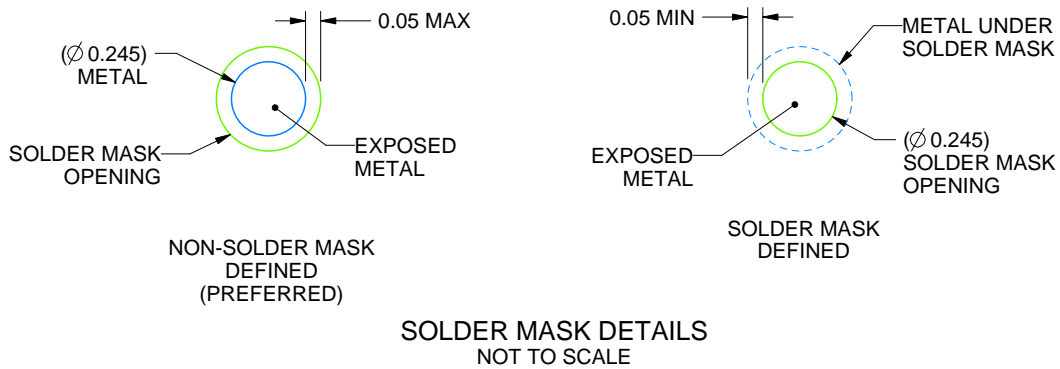

4226617/A 03/2021

NOTES: (continued)

- Final dimensions may vary due to manufacturing tolerance considerations and also routing constraints. See Texas Instruments Literature No. SNVA009 (www.ti.com/lit/snva009).

EXAMPLE STENCIL DESIGN

YZH0016

DSBGA - 0.625 mm max height

DIE SIZE BALL GRID ARRAY

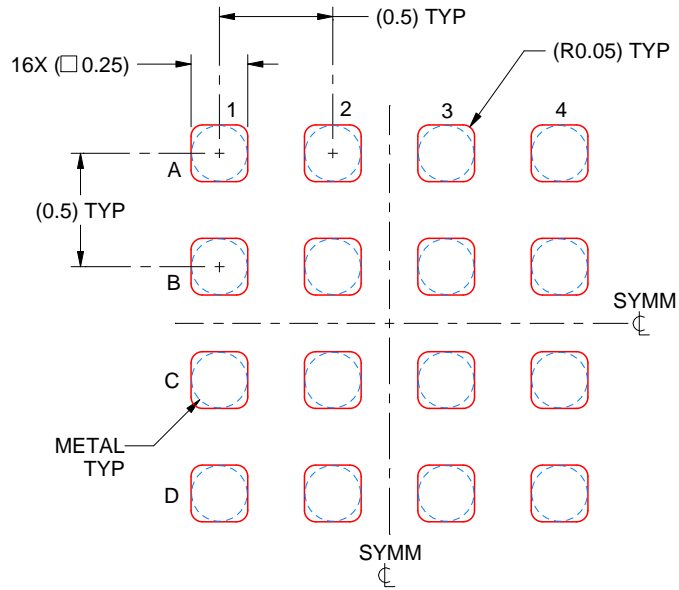

SOLDER PASTE EXAMPLE
BASED ON 0.075 mm THICK STENCIL
SCALE: 30X

4226617/A 03/2021

NOTES: (continued)

4. Laser cutting apertures with trapezoidal walls and rounded corners may offer better paste release.

GENERIC PACKAGE VIEW

RTJ 20

WQFN - 0.8 mm max height

4 x 4, 0.5 mm pitch

PLASTIC QUAD FLATPACK - NO LEAD

This image is a representation of the package family, actual package may vary.
Refer to the product data sheet for package details.

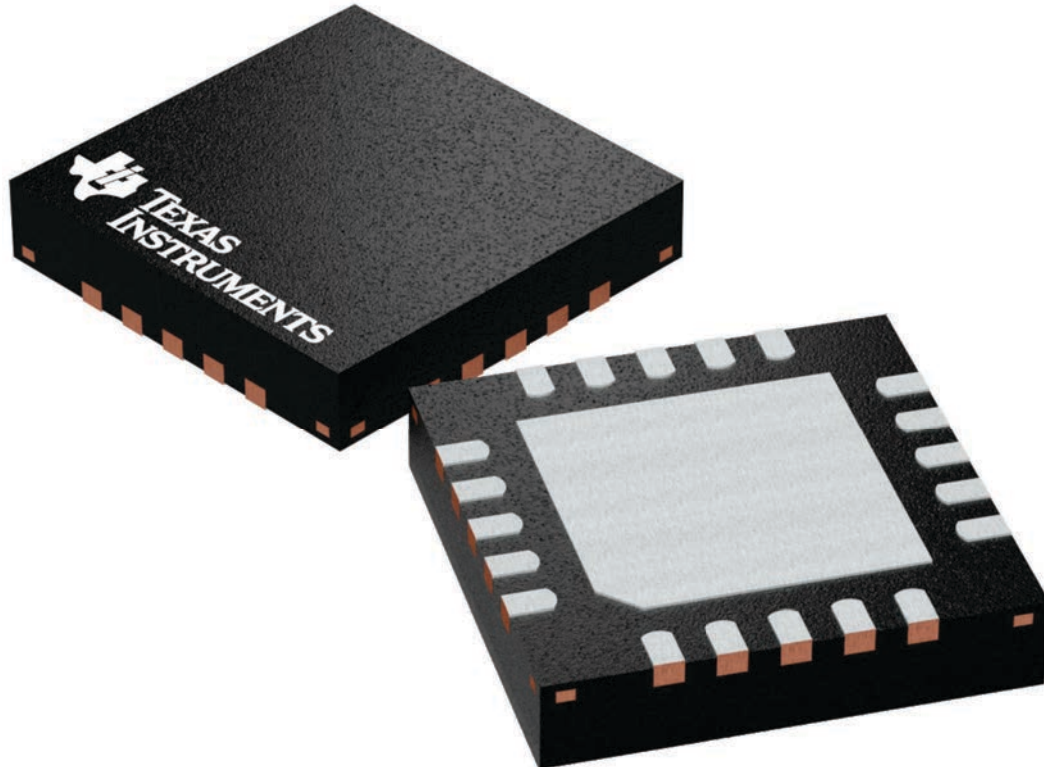

4224842/A

DATA BOOK PACKAGE OUTLINE

| |
|-------------------|
| LEADFRAME EXAMPLE |
| 4222370 |

| | | | | | | | | | | | |
|----------------------------------|---------------------|--|--|-------|------|-----|---|---|-----|------|---|
| DRAFTSMAN: H. DENG | DATE: 09/12/2016 | | DIMENSIONS IN MILLIMETERS | | | | | | | | |
| DESIGNER: H. DENG | DATE: 09/12/2016 |  TEXAS INSTRUMENTS SEMICONDUCTOR OPERATIONS | CODE IDENTITY NUMBER 01295 | | | | | | | | |
| CHECKER: V. PAKU & T. LEQUANG | DATE: 09/12/2016 | | ePOD, RTJ0020D / WQFN, 20 PIN, 0.5 MM PITCH | | | | | | | | |
| ENGINEER: T. TANG | DATE: 09/12/2016 | | | | | | | | | | |
| APPROVED: E. REY & D. CHIN | DATE: 10/06/2016 | | | | | | | | | | |
| RELEASED: WDM | DATE: 10/24/2016 | | | | | | | | | | |
| TEMPLATE INFO: EDGE# 4218519 | DATE: 04/07/2016 | <table border="1" style="display: inline-table; border-collapse: collapse;"> <tr> <td style="padding: 2px;">SCALE</td> <td style="padding: 2px;">SIZE</td> </tr> <tr> <td style="text-align: center;">15X</td> <td style="text-align: center;">A</td> </tr> </table> | | SCALE | SIZE | 15X | A | <table border="1" style="display: inline-table; border-collapse: collapse;"> <tr> <td style="padding: 2px;">REV</td> <td style="padding: 2px;">PAGE</td> </tr> <tr> <td style="text-align: center;">A</td> <td style="text-align: center;">1 OF 5</td> </tr> </table> | REV | PAGE | A |
| SCALE | SIZE | | | | | | | | | | |
| 15X | A | | | | | | | | | | |
| REV | PAGE | | | | | | | | | | |
| A | 1 OF 5 | | | | | | | | | | |

EXAMPLE STENCIL DESIGN

WQFN - 0.8 mm max height

RTJ0020D

PLASTIC QUAD FLATPACK - NO LEAD

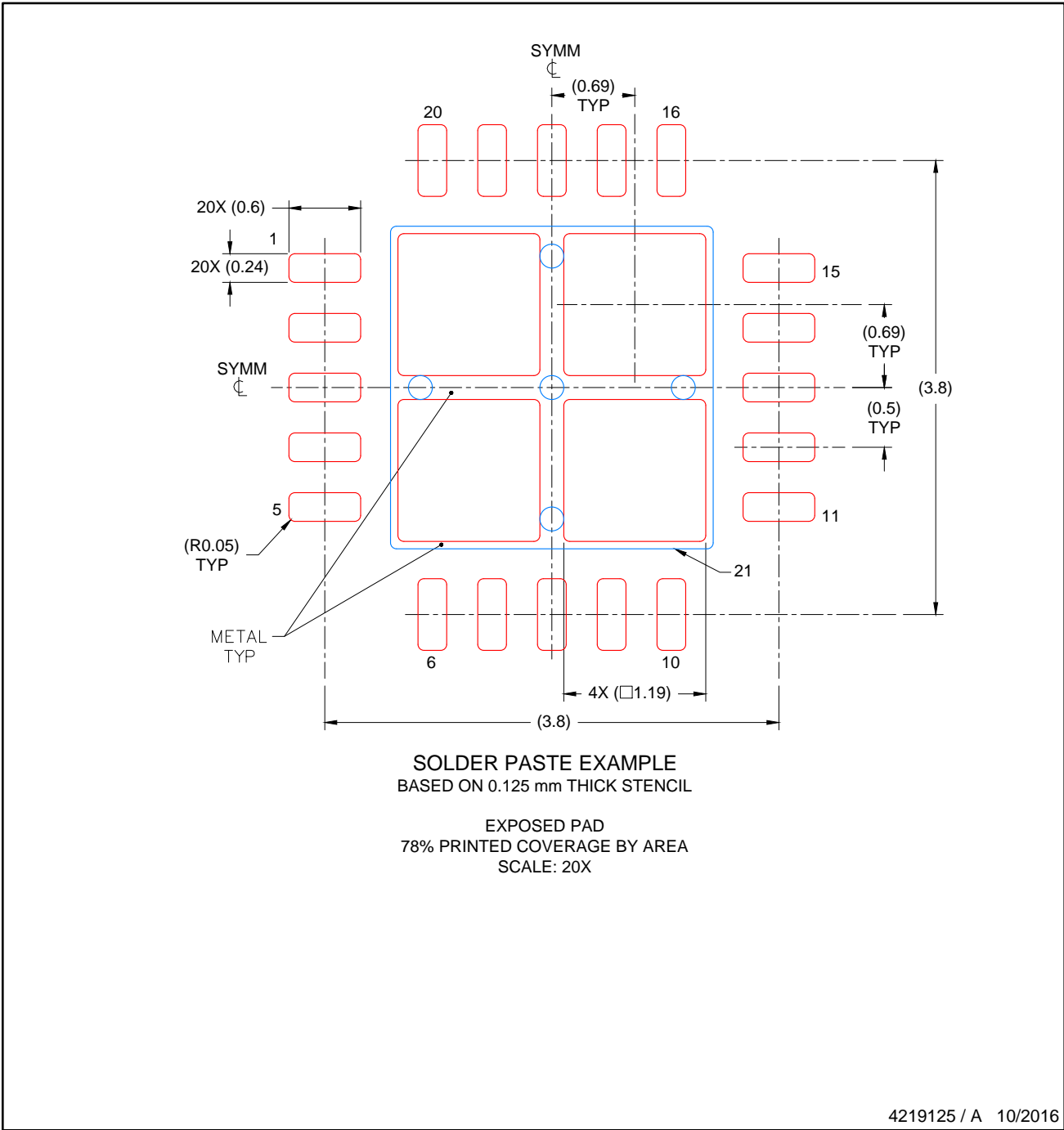

NOTES: (continued)

- 6. Laser cutting apertures with trapezoidal walls and rounded corners may offer better paste release. IPC-7525 may have alternate design recommendations..

REVISIONS

| REV | DESCRIPTION | ECR | DATE | ENGINEER / DRAFTSMAN |
|-----|---------------------|---------|------------|----------------------|
| A | RELEASE NEW DRAWING | 2160736 | 10/24/2016 | T. TANG / H. DENG |

Large empty rectangular area for drawing content.

MECHANICAL DATA

RTJ (S-PWQFN-N20)

PLASTIC QUAD FLATPACK NO-LEAD

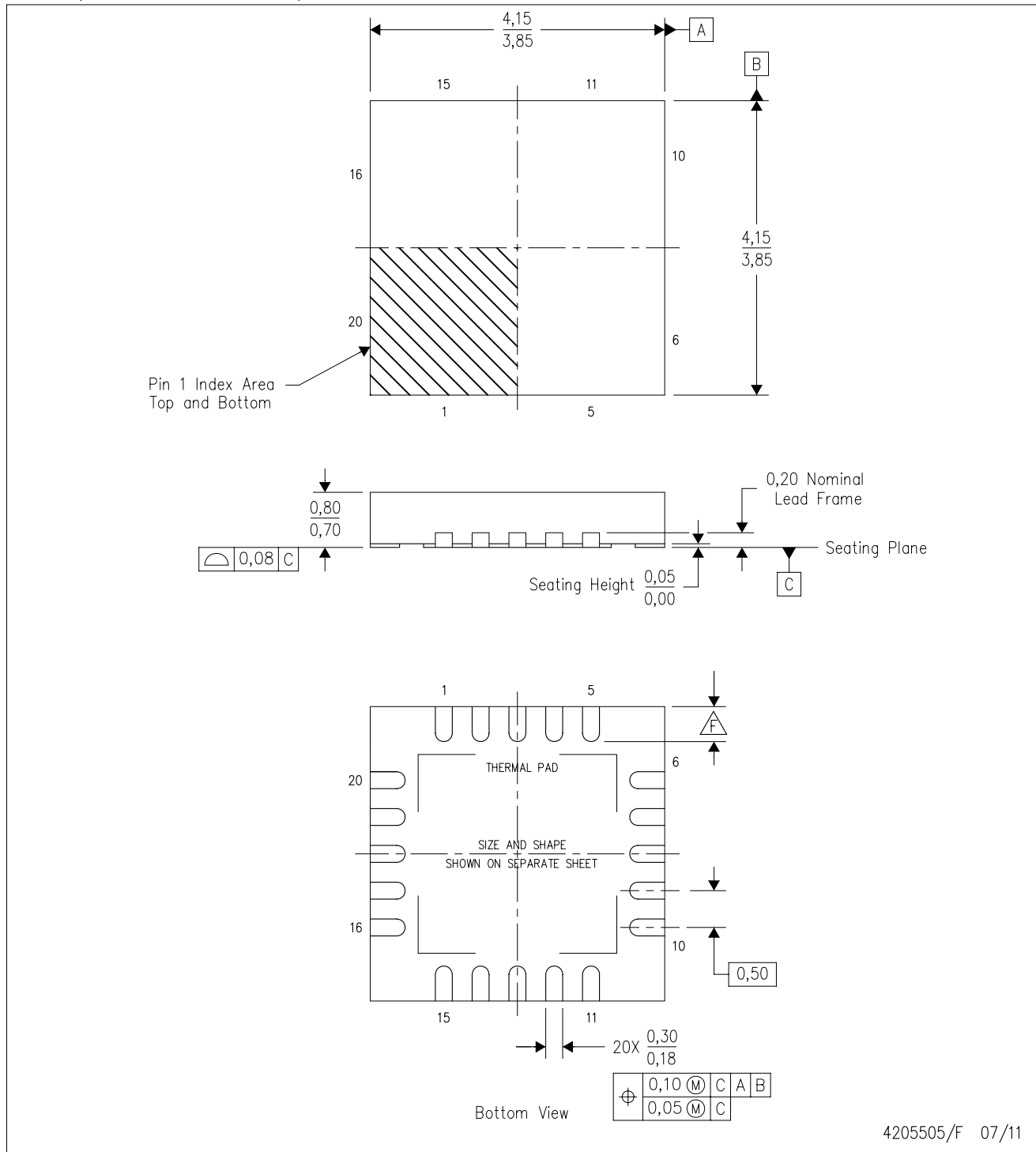

4205505/F 07/11

- NOTES:
- All linear dimensions are in millimeters. Dimensioning and tolerancing per ASME Y14.5-1994.
 - This drawing is subject to change without notice.
 - QFN (Quad Flatpack No-Lead) package configuration.
 - The package thermal pad must be soldered to the board for thermal and mechanical performance.
 - See the additional figure in the Product Data Sheet for details regarding the exposed thermal pad features and dimensions.
- ⚠ Check thermal pad mechanical drawing in the product datasheet for nominal lead length dimensions.

RTJ (S-PWQFN-N20)

PLASTIC QUAD FLATPACK NO-LEAD

THERMAL INFORMATION

This package incorporates an exposed thermal pad that is designed to be attached directly to an external heatsink. The thermal pad must be soldered directly to the printed circuit board (PCB). After soldering, the PCB can be used as a heatsink. In addition, through the use of thermal vias, the thermal pad can be attached directly to the appropriate copper plane shown in the electrical schematic for the device, or alternatively, can be attached to a special heatsink structure designed into the PCB. This design optimizes the heat transfer from the integrated circuit (IC).

For information on the Quad Flatpack No-Lead (QFN) package and its advantages, refer to Application Report, QFN/SON PCB Attachment, Texas Instruments Literature No. SLUA271. This document is available at www.ti.com.

The exposed thermal pad dimensions for this package are shown in the following illustration.

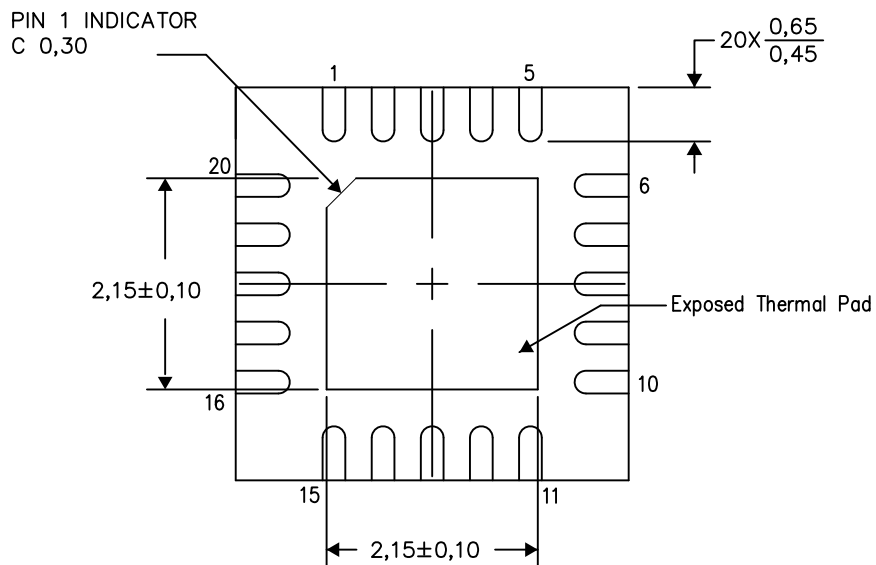

Bottom View

Exposed Thermal Pad Dimensions

4206256-3/V 05/15

NOTE: All linear dimensions are in millimeters

IMPORTANT NOTICE AND DISCLAIMER

TI PROVIDES TECHNICAL AND RELIABILITY DATA (INCLUDING DATA SHEETS), DESIGN RESOURCES (INCLUDING REFERENCE DESIGNS), APPLICATION OR OTHER DESIGN ADVICE, WEB TOOLS, SAFETY INFORMATION, AND OTHER RESOURCES "AS IS" AND WITH ALL FAULTS, AND DISCLAIMS ALL WARRANTIES, EXPRESS AND IMPLIED, INCLUDING WITHOUT LIMITATION ANY IMPLIED WARRANTIES OF MERCHANTABILITY, FITNESS FOR A PARTICULAR PURPOSE OR NON-INFRINGEMENT OF THIRD PARTY INTELLECTUAL PROPERTY RIGHTS.

These resources are intended for skilled developers designing with TI products. You are solely responsible for (1) selecting the appropriate TI products for your application, (2) designing, validating and testing your application, and (3) ensuring your application meets applicable standards, and any other safety, security, regulatory or other requirements.

These resources are subject to change without notice. TI grants you permission to use these resources only for development of an application that uses the TI products described in the resource. Other reproduction and display of these resources is prohibited. No license is granted to any other TI intellectual property right or to any third party intellectual property right. TI disclaims responsibility for, and you will fully indemnify TI and its representatives against, any claims, damages, costs, losses, and liabilities arising out of your use of these resources.

TI's products are provided subject to [TI's Terms of Sale](#) or other applicable terms available either on ti.com or provided in conjunction with such TI products. TI's provision of these resources does not expand or otherwise alter TI's applicable warranties or warranty disclaimers for TI products.

TI objects to and rejects any additional or different terms you may have proposed.

Mailing Address: Texas Instruments, Post Office Box 655303, Dallas, Texas 75265
Copyright © 2022, Texas Instruments Incorporated