



PSI Bluetooth converter

User manual

User manual

PSI Bluetooth converter with two digital diagnostics outputs

2014-07-09

Designation: UM EN PSI-WL-RS232-RS485/BT/2DO

Revision: 00

This user manual is valid for:

Designation:	Order No.
PSI-WL-RS232-RS485/BT/2DO	2313805
PSI-WL-PROFIB/BT-SET/2DO	2313876
PSI-WL-RS232-RS485/BT/HL	2313795

Please observe the following notes

User group of this manual

The use of products described in this manual is oriented exclusively to qualified electricians or persons instructed by them, who are familiar with applicable standards and other regulations regarding electrical engineering and, in particular, the relevant safety concepts.

Explanation of symbols used and signal words



This is the safety alert symbol. It is used to alert you to potential personal injury hazards. Obey all safety measures that follow this symbol to avoid possible injury or death.

There are three different categories of personal injury that are indicated with a signal word.

DANGER This indicates a hazardous situation which, if not avoided, will result in death or serious injury.

WARNING This indicates a hazardous situation which, if not avoided, could result in death or serious injury.

CAUTION This indicates a hazardous situation which, if not avoided, could result in minor or moderate injury.



This symbol together with the signal word **NOTE** and the accompanying text alert the reader to a situation which may cause damage or malfunction to the device, hardware/software, or surrounding property.



This symbol and the accompanying text provide the reader with additional information or refer to detailed sources of information.

How to contact us

Internet

Up-to-date information on Phoenix Contact products and our Terms and Conditions can be found on the Internet at:

phoenixcontact.com

Make sure you always use the latest documentation.

It can be downloaded at:

phoenixcontact.net/products

Subsidiaries

If there are any problems that cannot be solved using the documentation, please contact your Phoenix Contact subsidiary.

Subsidiary contact information is available at phoenixcontact.com.

Published by

PHOENIX CONTACT GmbH & Co. KG
Flachsmarktstraße 8
32825 Blomberg
GERMANY

Should you have any suggestions or recommendations for improvement of the contents and layout of our manuals, please send your comments to:

tecdoc@phoenixcontact.com

Please observe the following notes

General terms and conditions of use for technical documentation

Phoenix Contact reserves the right to alter, correct, and/or improve the technical documentation and the products described in the technical documentation at its own discretion and without giving prior notice, insofar as this is reasonable for the user. The same applies to any technical changes that serve the purpose of technical progress.

The receipt of technical documentation (in particular user documentation) does not constitute any further duty on the part of Phoenix Contact to furnish information on modifications to products and/or technical documentation. You are responsible to verify the suitability and intended use of the products in your specific application, in particular with regard to observing the applicable standards and regulations. All information made available in the technical data is supplied without any accompanying guarantee, whether expressly mentioned, implied or tacitly assumed.

In general, the provisions of the current standard Terms and Conditions of Phoenix Contact apply exclusively, in particular as concerns any warranty liability.

This manual, including all illustrations contained herein, is copyright protected. Any changes to the contents or the publication of extracts of this document is prohibited.

Phoenix Contact reserves the right to register its own intellectual property rights for the product identifications of Phoenix Contact products that are used here. Registration of such intellectual property rights by third parties is prohibited.

Other product identifications may be afforded legal protection, even where they may not be indicated as such.

Table of contents

1	Technical data	7
2	For your safety	13
	2.1 Intended use.....	13
	2.2 UL note (for PSI-WL-RS232-RS485/BT/2DO and PSI-WL-PROFIB/BT-SET/2DO only).....	14
	2.3 UL note (for PSI-WL-RS232-RS485/BT/HL with HazLoc approval only)	14
3	Product description	15
	3.1 Bluetooth PROFIBUS set	15
	3.2 Dimensions.....	16
	3.3 Block diagram.....	16
	3.4 Connection and function elements	17
	3.5 System configuration	18
4	Setting switches on the device	19
	4.1 Opening and closing the housing	19
	4.2 Activating the termination network.....	20
	4.3 Setting configuration mode.....	21
	4.4 Resetting to the default settings.....	22
5	Installation and configuration	23
	5.1 Mounting as single device	23
	5.2 Combined assembly.....	24
	5.3 Removal	25
	5.4 Power supply	26
	5.5 Serial pin assignments	27
	5.6 Antenna connection.....	29
	5.7 Diagnostics and status indicators	29
	5.8 Digital diagnostics outputs.....	30
	5.9 Configuration	31
6	Application examples	33
7	Planning wireless systems	35
	7.1 Planning wireless paths.....	35
	7.2 Practical test.....	35
	7.3 Selecting antenna cables and antennas	36
	7.4 Installing antennas.....	37

7.5	Level and attenuation of the Bluetooth converter and accessories	38
7.6	Free space path loss	40
7.7	Propagation of radio waves	41
7.8	Fresnel zone.....	44
7.9	Range.....	46
7.10	Equivalent isotropically radiated power (EIRP)	47
7.11	System calculation in free space	47
7.12	Practical examples	49
8	Detecting and removing errors	51
8.1	Loopback test during serial data transmission.....	51
9	AT commands	53
9.1	Command descriptions.....	55
9.2	Connection commands.....	56
9.3	Reading the service profile	63
9.4	Data mode.....	65
9.5	Information commands.....	69
9.6	Interface commands.....	70
9.7	Additional commands.....	72
A	Technical appendix.....	75
A 1	Typical combinations of antennas and adapter cables	75
A 2	Configuring a PROFIBUS connection.....	79
B	Appendixes.....	97
B 1	List of figures	97
B 2	List of tables	99
B 3	Index.....	101

1 Technical data

Description	Type	Order No.	Pcs. / Pkt.
Bluetooth converter, wireless transmission: RS-232/RS-422/RS-485 2-wire, mounting on EN DIN rails, MCX connection for external antenna, integrated path diagnostics: bar graph + two digital outputs, cross-wiring of 24 V DC and RS-485 2-wire	PSI-WL-RS232-RS485/BT/2DO	2313805	1
Bluetooth PROFIBUS SET, pre-configured: PROFIBUS point-to-point, PROFIBUS baud rate: 187.5 kbps, integrated path diagnostics: bar graph + two digital outputs, cross-wiring of 24 V DC and RS-485 2-wire, contents: 2 x Bluetooth converter + 2 x antenna	PSI-WL-PROFIB/BT-SET/2DO	2313876	1
Bluetooth converter, wireless transmission: RS-232/RS-422/RS-485 2-wire, mounting on EN DIN rails, MCX connection for external antenna, integrated path diagnostics: bar graph, cross-wiring of 24 V DC and RS-485 2-wire, UL-HazLoc approval	PSI-WL-RS232-RS485/BT/HL	2313795	1
Accessories	Type	Order No.	Pcs. / Pkt.
RS-232 cable, D-SUB 9 socket to D-SUB 9 socket, 9-wire, 1:1	PSM-KA9SUB9/BB/0,5METER	2708520	1
RS-232 cable, D-SUB 9 socket to D-SUB 9 socket, 9-wire, 1:1	PSM-KA9SUB9/BB/2METER	2799474	1
D-SUB connector, 9-pos. socket, one cable entry < 35°, universal type for all systems, pin assignment: 1, 2, 3, 4, 5, 6, 7, 8, 9 to screw connection terminal block	SUBCON 9/F-SH	2761499	1
RS-232 null modem connector	PSM-AD-D9-NULMODEM	2708753	1
USB 2.0 cable, USB A connector to Mini-USB B socket, length: 1 m	PSI-CA-USB A/MINI B/1METER	2313575	1
USB connecting cable: USB connector type A to USB connector type Mini-B; length: 3 m	CABLE-USB/MINI-USB-3,0M	2986135	1
D-SUB 9 data cable to USB, with adapter D-SUB 9 to D-SUB 25	CM-KBL-RS232/USB	2881078	1
RS-232 cable, D-SUB 9 socket to D-SUB 25 socket	PSM-KA 9 SUB 25/BB/2METER	2761059	1
Adapter cable to connect the IB IL RS232 and IB IL RS232-PRO Inline communication terminals to the interface converter, e.g., modem, Com server, Bluetooth or fiber optics.	PSM-KAD-IL RS232/9SUB/B/0,8M	2319200	1
DIN rail connector for DIN rail mounting. Universal for T-BUS housing. Gold-plated contacts, 5-pos. Header, nominal current: 8 A, product with gold-plated contacts, bus connectors for connecting with electronic housings	ME 17,5 TBUS 1,5/ 5-ST-3,81 GN	2709561	10
DIN rail connector for DIN rail mounting. Universal for T-BUS housing. Gold-plated contacts, 5-pos. Header, nominal current: 8 A, pitch: 3.81 mm, product with gold-plated contacts, bus connectors for connecting with electronic housings	ME 22,5 TBUS 1,5/ 5-ST-3,81 GN	2707437	50
DIN rail power supply unit, primary switched, slim design, output: 24 V DC/1.5 A	MINI-SYS-PS-100-240AC/24DC/1.5	2866983	1
Omnidirectional antenna, 2.4 GHz, 2 dBi, linear vertical, 1.5 m cable, MCX (male), IP65 degree of protection, 50 Ω impedance	RAD-ISM-2400-ANT-OMNI-2-1	2867461	1
Bluetooth USB adapter for direct installation on USB type A ports and wireless transmission from USB interfaces	PSI-WL-PLUG-USB/BT	2313083	1
Omnidirectional antenna with protection against vandalism, 2.4 GHz, 3 dBi gain, IP55 protection, 1.5 m cable length, MCX (male) connection, h/v 360°/85° apex angle. Appropriate mounting material is available for wall mounting.	RAD-ISM-2400-ANT-VAN- 3-1-MCX	2885702	1
Omnidirectional antenna, 2.4 GHz, 6 dBi, linear vertical, N (female), IP55, 50 Ω impedance	RAD-ISM-2400-ANT-OMNI-6-0	2885919	1
Omnidirectional antenna, 2.4 GHz, 6 dBi, linear vertical, h/v 360°/20° apex angle, N (female), IP65, salt water resistant	RAD-2400-ANT-OMNI-6-0-SW	2903219	1
Panel antenna, 2.4/5GHz, 9 dBi, linear vertical, N (female), IP67, incl. mounting bracket and mast clips for 25 - 85 mm diameter, stainless steel	ANT-DIR-2459-01	2701186	1

PSI-WL-RS232-RS485/BT/2DO

Accessories [...]	Type	Order No.	Pcs. / Pkt.
Panel antenna, IP55 protection, 8 dBi gain, linear vertical, SMA (female), 50 Ω impedance, h/v 75°/70° apex angle	RAD-ISM-2400-ANT-PAN- 8-0	2867610	1
Antenna cable, 3 m length; SMA (male) -> SMA (male), attenuation approx. 0.93 dB/m at 2.4 GHz; 50 Ω impedance	RAD-CAB-EF142-3M	2884512	1
Antenna cable, 5 m length; SMA (male) -> SMA (male), attenuation approx. 0.93 dB/m at 2.4 GHz; 50 Ω impedance	RAD-CAB-EF142-5M	2884525	1
Antenna cable, 3 m length; N (male) -> N (male), attenuation approx. 0.45 dB/m at 2.4 GHz; 50 Ω impedance	RAD-CAB-EF393- 3M	2867649	1
Antenna cable, 5 m length; N (male) -> N (male), attenuation approx. 0.45 dB/m at 2.4 GHz; 50 Ω impedance	RAD-CAB-EF393- 5M	2867652	1
Antenna cable, 10 m length; N (male) -> N (male), attenuation approx. 0.45 dB/m at 2.4 GHz; 50 Ω impedance	RAD-CAB-EF393-10M	2867665	1
Antenna extension cable, 15 m length; N (male) -> N (male), attenuation approx. 0.45 dB/m at 2.4 GHz; 50 Ω impedance	RAD-CAB-EF393-15M	2885634	1
Vulcanizing sealing tape for external protection of adapters, cable connections, etc. against the effects of weather, roll length: 3 m	RAD-TAPE-SV-19-3	2903182	1
Adapter cable, pigtail 100 cm MCX (male) -> SMA (male), insertion loss 1.5 dB at 2.4 GHz; 50 Ω impedance	RAD-PIG-EF316-MCX-SMA	2867678	1
Adapter cable, pigtail 50 cm MCX (male) -> N (male), insertion loss 1.5 dB at 2.4 GHz; 50 Ω impedance	RAD-PIG-EF316-MCX-N	2867681	1
Adapter cable, pigtail 30 cm N (female) -> SMA (male), insertion loss 1.5 dB at 2.4 GHz; 50 Ω impedance	RAD-PIG-EF316-N-SMA	2867694	1
Adapter cable, pigtail 50 cm N (female) -> N (female), insertion loss 1.5 dB at 2.4 GHz; 50 Ω impedance	RAD-PIG-EF316-N-N	2867704	1
Attachment plug with LAMBDA/4 technology as surge protection for coaxial signal interfaces. Connection: N connectors (socket/socket)	CN-LAMBDA/4-5.9-BB	2838490	1
Adapter, SMA (female) -> SMA (female); insertion loss <0.3 dB at 2.4 GHz	RAD-ADP-SMA/F-SMA/F	2884541	1
Adapter, N (male) -> SMA (female); insertion loss <0.3 dB at 2.4 GHz	RAD-ADP-N/M-SMA/F	2917036	1

Supply

Supply voltage range	10 V DC ... 30 V DC (via COMBICON plug-in screw terminal block) 19 V AC ... 29 V AC (50/60 Hz)
Nominal supply voltage	24 V DC ±20% (alternative or redundant, via backplane bus contact and system power supply)
Typical current consumption	≤ 100 mA (24 V DC)
Electrical isolation	VCC // Bluetooth, RS-232, RS-422, RS-485, USB
Test voltage data interface/power supply	1.5 kV AC (50 Hz, 1 min)

RS-232 interface, according to ITU-T V.28, EIA/TIA-232, DIN 66259-1

Connection method	D-SUB 9 connector
Data format/coding	Serial asynchronous UART/NRZ, 8 data, 1/2 stop, 1 parity, 10/11-bit character length
Serial transmission speed	1.2; 2.4; 4.8; 7.2; 9.6; 19.2; 31.25; 38.4; 57.6; 75; 93.75; 115.2 kbps
Transmission length	≤ 15 m
Data flow control/protocols	Software handshake, Xon/Xoff, hardware handshake RTS/CTS, 3964R-compatible,
Pin assignment	DCE (Data Communication Equipment)



The RS-232 interface and the USB interface cannot be used simultaneously.

RS-422 interface, according to ITU-T V.11, EIA/TIA-422, DIN 66348-1

Connection method	Plug-in screw connection
Data format/coding	Serial asynchronous UART/NRZ, 8 data, 1/2 stop, 1 parity, 10/11-bit character length
Termination resistor	390 Ω - 180 Ω - 390 Ω, can be configured
Serial transmission speed	1.2; 2.4; 4.8; 7.2; 9.6; 19.2; 31.25; 38.4; 57.6; 75; 93.75; 115.2; 136; 187.5 kbps
Transmission length	≤ 1200 m
Data flow control/protocols	Automatic control

RS-485 interface, according to EIA/TIA-485, DIN 66259-4/RS-485 2-wire

Connection method	Plug-in screw connection
Data format/coding	Serial asynchronous UART/NRZ, 8 data, 1/2 stop, 1 parity, 10/11-bit character length
Termination resistor	390 Ω - 180 Ω - 390 Ω, can be configured
Serial transmission speed	1.2; 2.4; 4.8; 7.2; 9.6; 19.2; 31.25; 38.4; 57.6; 75; 93.75; 115.2; 136; 187.5 kbps
Transmission length	≤ 1200 m
Data flow control/protocols	Automatic control

USB 2.0

Connection method	Mini-USB B, socket
-------------------	--------------------

Wireless interface

Interface description	Bluetooth 2.1 + EDR
Frequency range	2.402 GHz ... 2.48 GHz (ISM band)
Antenna	External
Connection method	MCX socket
Channel distance	1 MHz
Bandwidth	79 MHz
Number of channels	79
Transmission method	1.6 kHz (FHSS)
Minimum transmission power	-28 dBm (can be set via software)
Maximum transmission power	14 dBm (can be set via software)
Range	≤ 150 m (14 dBm)
Minimum receiver sensitivity	-91 dBm
Bluetooth multipoint master/slave	1/7
Operating mode	GAP: Generic Access Profile (method for authentication and connection establishment) SDAP: Service Discovery Application (method for requesting supported services) SPP: Serial Port Profile (COM port emulation method) DUN: Dial-Up Networking Profile (modem dialing method) LAP: LAN Access Point Profile (network connection method)

General data

Degree of protection	IP20
Dimensions (W/H/D)	22.5 mm x 99 mm x 116 mm
Weight	120 g
Housing material	PA 6.6-FR, green
Free fall according to IEC 60068-2-32	1 m
Vibration resistance according to EN 60068-2-6/IEC 60068-2-6	5g, 150 Hz, 2.5 h, in XYZ direction
Shock according to EN 60068-2-27/IEC 60068-2-27	15g, 11 ms period, half-sine shock pulse
MTTF (Mean Time To Failure) SN 29500 standard, temperature 25°C, operating cycle 21% (5 days per week, 8 hours per day)	2115 years
MTTF (Mean Time To Failure) SN 29500 standard, temperature 40 °C, operating cycle 34.25% (5 days per week, 12 hours per day)	850 years
MTTF (Mean Time To Failure) SN 29500 standard, temperature 40 °C, operating cycle 100% (7 days per week, 24 hours per day)	346 years
Noise emission according to	EN 55011
Noise immunity according to	EN 61000-6-2:2005
Electromagnetic compatibility	Conformance with R&TTE directive 1999/5/EC

Ambient conditions

Ambient temperature (operation)	-20°C ... 60°C
Ambient temperature (storage/transport)	-40°C ... 85°C
Permissible humidity (operation)	10% ... 95% (non-condensing)
Permissible humidity (storage/transport)	5% ... 95% (non-condensing)

Approvals

Conformance	CE-compliant
Free from substances that would hinder coating with paint or varnish	According to P-VW 3.10.7 57 65 0 VW-AUDI-Seat central standard
UL, USA/Canada	cULus listed UL 508
Standards/regulations	FCC Part 15.247/ISC RSS 210

Conformance with R&TTE directive 1999/5/EC

Noise immunity according to EN 61000-6-2

Electrostatic discharge	EN 61000-4-2	
	Contact discharge	± 6 kV
	Air discharge	± 8 kV
	Remark	Criterion B
Electromagnetic HF field	EN 61000-4-3	
	Frequency range	80 MHz ... 3 GHz
	Field strength	10 V/m
	Remark	Criterion A
Fast transients (burst)	EN 61000-4-4	
	Input	± 2 kV
	Signal	± 2 kV
	Remark	Criterion B
Surge current loads (surge)	EN 61000-4-5	
	Input	± 2 kV
	Signal	± 1 kV
	Remark	Criterion B
Conducted influence	EN 61000-4-6	
	Voltage	10 V
	Remark	Criterion A

Noise emission according to EN 61000-6-4

Emission	EN 55022
Criterion A	Normal operating behavior within the specified limits
Criterion B	Temporary impairment to operating behavior that is corrected by the device itself

R&TTE directive 1999/5/EC

EMC - immunity to interference (electromagnetic compatibility of wireless systems)	EN 61000-6-2	Generic standard for the industrial sector
Safety - protection of personnel with regard to electrical safety	EN 60950-1	
Health - limitation of exposure of the population to electromagnetic fields	Gazette of the European Communities 1999/519/EC	Recommendation of the Council of the European Community from July 12, 1999
Wireless communication - effective use of the frequency spectrum and prevention of wireless communication interference	ETSI EN 300328: V1.4.1, V1.2.1	

2 For your safety



WARNING:

Observe the following safety notes when using the device.

- Only qualified specialist personnel may install, start up, and operate the device. National safety and accident prevention regulations must be observed.
- Installation should be carried out as described in the installation notes. Access to circuits within the device is not permitted.
- The device is maintenance-free. Repairs may only be carried out by the manufacturer.
- The device is only intended for operation in the control cabinet and with SELV according to IEC 60950/EN 60950/VDE 0805. The device may only be connected to devices, which meet the requirements of EN 60950.

2.1 Intended use

This device is licensed for operation with a maximum transmission power of 100 mW (20 dBm) in the following countries:

Austria, Belarus*, Belgium, Bulgaria, Cyprus, Czech Republic, Denmark, Estonia, Finland, France, Germany, Great Britain, Greece, Hungary, Iceland, Italy, Ireland, Latvia, Liechtenstein, Lithuania, Luxembourg, Malta, the Netherlands, Norway*, Poland, Portugal, Romania, Sweden, Slovakia, Slovenia, Spain, Switzerland, Turkey* (approvals for other countries available on request).

*This device complies with R&TTE device class 2, with the following restrictions on use according to ERC recommendation 70-03/April 2004:

Belarus	Maximum transmission power outside buildings of 25 mW (14 dBm)
Norway	The device must not be operated within 20 km of the Ny Ålesund town center.
Turkey	The device must only be operated with Phoenix Contact antennas (see "Wireless accessories" data sheet, document no. 101580) - according to the "Short Range Radio Devices (SRD) Regulations" Gazette No. 26464 dated March 16, 2007.

Operation of the wireless system is only permitted if accessories available from Phoenix Contact are used. The use of other accessory components may invalidate the operating license.

Please observe that the maximum permissible transmission power of the device can be exceeded in combination with antennas.

- RAD-ISM-2400-ANT-PAN-8-0 and ANT-DIR-2459-01: set the transmission power via the software.
Hungary: this combination may not be used!

2.2 UL note (for PSI-WL-RS232-RS485/BT/2DO and PSI-WL-PROFIB/BT-SET/2DO only)



Wire Range: 30-12 AWG

Torque: 5-7 (Lbs-In)

"Maximum Ambient Temperature 60°C"

Environmental designation: "Open Type Device"

2.3 UL note (for PSI-WL-RS232-RS485/BT/HL with HazLoc approval only)



WARNING: Explosion hazard when used in potentially explosive areas

Only use digital outputs DO1 and DO2 in the safe area. They are **not** suitable for use in potentially explosive areas.

INDUSTRIAL CONTROL EQUIPMENT 11AE

10 ... 30 V DC <170 mA, 24 V AC $\pm 20\%$ <110 mA, Class 2

Wire Range: 30-12 AWG

Torque: 5-7 (Lbs-In)

Maximum Ambient Temperature 60°C

Environmental designation: "Open Type Device"

PROCESS CONTROL EQUIPMENT FOR HAZARDOUS LOCATIONS 31ZN

- A This equipment is suitable for use in Class I, Zone 2, AEx nA IIC T6; Class I, Zone 2, Ex nA IIC T6 Gc X and Class I, Division 2, Groups A, B, C, D or non-hazardous locations only.
- B Conductor temperature rating must be 65°C or higher.
- C Product must be installed in Class I, Zone 2 certified and at least an IP54 enclosure.
- D Product must be used in no more than a pollution degree 2 environment as defined by IEC 60664-1.
- E Provisions must be made to provide transient protection to the product so that voltage levels do not exceed 40% of the rated voltage at the power supply terminals.
- F The product has to be installed in an enclosure with tool removable cover or door.

Ambient temperature: -20°C ... +60°C

24 V AC <100 mA, 24 V DC <170 mA

Wire Range: 30-12 AWG

Torque: 5-7 (Lbs-In)

3 Product description



The **PSI-WL-RS232-RS485/BT/2DO** PSI Bluetooth converter provides a quick and easy wireless connection between serial interfaces of the RS-232, RS-422, and RS-485 2-wire standard. Data connections can be established to third-party devices or the **PSI-WL-PLUG-RS232/BT** Bluetooth RS-232 adapter. Programming or diagnostic access to controllers or a wireless master/slave network can easily be implemented in fieldbus systems regardless of the location.

The PSI Bluetooth converter has been specially designed to meet the requirements of industrial environments and supports operation without software drivers, thanks to its fully integrated protocol stacks.

The wireless connection can extend up to 150 meters and is based on the international, license-free Bluetooth standard. This wireless standard meets high requirements for interference-free data transmission, in particular through the use of the FHSS method (Frequency Hopping Spread Spectrum) with the 2.4 GHz ISM band.

Features

- Mounted on EN DIN rails
- 24 V DC or AC supply
- Transmission speed can be set up to 187.5 kbps
- Either RS-232, RS-422 or RS-485
- Supports all common 10/11-bit UART data formats
- 3964R-compatible
- External antenna connection for optimum antenna positioning
- Bluetooth access protected by password, fixed device pairing or device access list
- Scalable transmission power for specific, spatial containment of the wireless cell
- Integrated Bluetooth path diagnostics via LED bar graph
- Two digital diagnostics outputs (**not** in the case of the PSI-WL-RS232-RS485/BT/HL product version)
- R&TTE device class: Class 2
- Bluetooth device class: Class 1, 14 dBm
- 79 channels, bandwidth: 79 MHz

3.1 Bluetooth PROFIBUS set

The **PSI-WL-PROFIB/BT-SET/2DO** Bluetooth PROFIBUS set consists of two permanently paired Bluetooth converters and two omnidirectional antennas. The devices are preconfigured for an invisible, password-protected point-to-point connection.



Features

- Transmission speed: 187.5 kbps
- Ready to use: unpack, connect, switch on - and you have a working wireless path

3.2 Dimensions

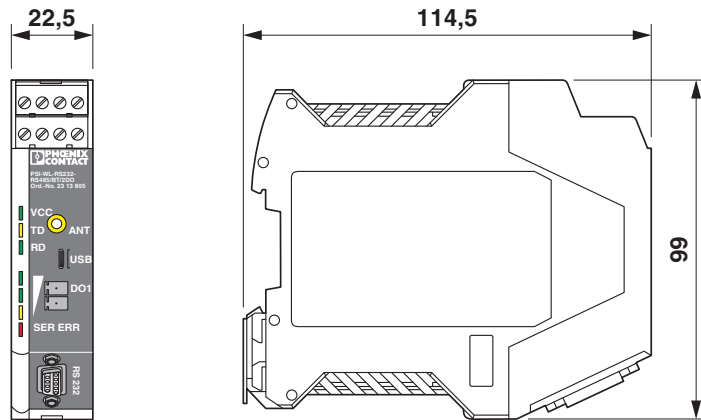

Figure 3-1 Dimensions [mm]

3.3 Block diagram

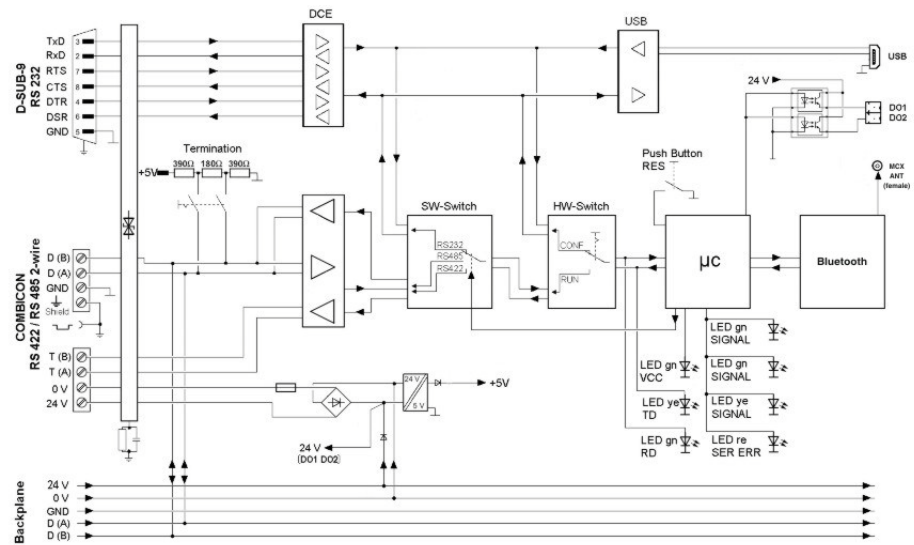

Figure 3-2 Block diagram

3.4 Connection and function elements

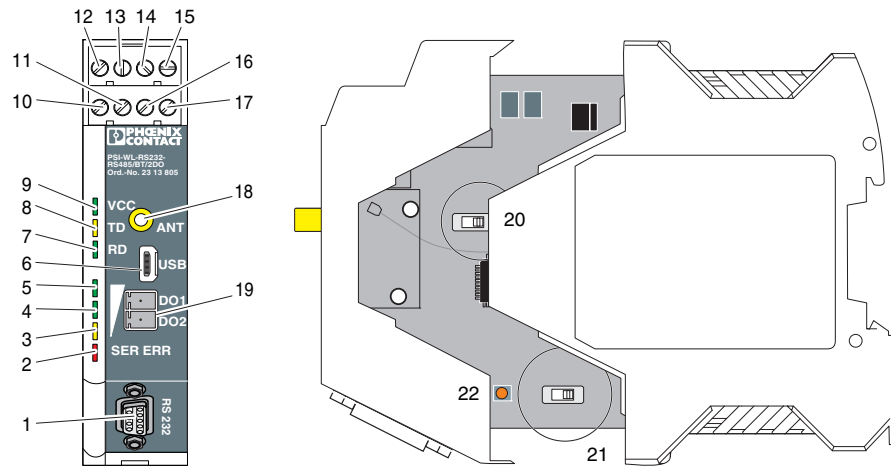

Figure 3-3 Design

- 1 D-SUB-9: RS-232 interface (pin strip)
- 2 Red LED, SER ERR, flashes during every serial error, e.g., parity, transmission speed
- 3-5 LED bar graph
- 6 Mini-USB type B: USB interface
- 7 Green LED, RD, receive data
- 8 Yellow LED, TD, transmit data
- 9 Green LED, VCC
- 10 Shield connection, same potential as FE
- 11 GND
- 12 24 V 24 V DC supply voltage
- 13 0 V 0 V DC supply voltage
- 14 T(A) RS-422 connection, negative
- 15 T(B) RS-422 connection, positive
- 16 D(A) RS-422/485 connection, negative
- 17 D(B) RS-422/485 connection, positive
- 18 Antenna connection (MCX socket)
- 19 DO1, DO2 Digital output of the wireless signal strength (only for use in safe areas)
- 20 Slide switch for RS-422/RS-485 termination network
- 21 CONF/RUN slide switch for configuration mode
- 22 Reset button

3.5 System configuration

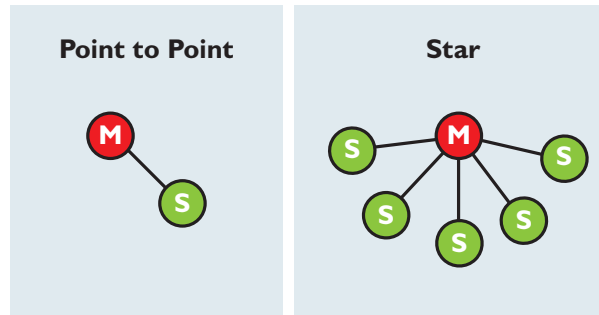

Figure 3-4 Point-to-point connection, point-to-multipoint network (star)

A point-to-multipoint network must only consist of a master and up to seven slaves. This network structure is characterized by each slave that is directly connected to the master. The more devices are connected to the master, the higher the delay time of the wireless network.

The Bluetooth converter can perform the following functions:

- **Master**
The master Bluetooth converter is the central point in the network. It coordinates initialization and network-specific functions. Wireless connections cannot be established without the master. The master in a wireless network is usually located at a central point, e.g., in the control center. The master PLC is connected to the master Bluetooth converter and is responsible for transmission management of the serial data. There may only be one master PLC in the network. Multi-master systems are not permitted.
- **Slave**
Slaves are always an end point in the network and not able to transmit data to other devices. The slaves of the PLC are connected to the slave Bluetooth converters. A slave Bluetooth converter only has subordinate rights.

Server roles or client roles can be assigned for a master or a slave. This is required for mobile applications, for example, if a slave is to connect to different masters.

- **Server**
The Bluetooth server accepts the connection that was initiated by a Bluetooth client. After successful connection establishment, it is not important which device is the server and which device is the client. Data transmission is transparent.
- **Client**
The Bluetooth client initiates the connection to a Bluetooth server. After successful connection establishment, it is not important which device is the server and which device is the client. Data transmission is transparent.

The client/server settings are important if several devices are installed in the immediate vicinity, e.g., in a control cabinet. A client establishes the connection to a server and increases the transmission power for this connection establishment. The transmission power is then reduced again automatically. If several clients are installed directly next to one another, crosstalk may occur for a short time. This may lead to interferences or even a failure of the wireless connection. To avoid this, only servers must be installed next to one another.

4 Setting switches on the device

**NOTE: Electrostatic discharge**

The device contains components that can be damaged or destroyed by electrostatic discharge. When handling the device, observe the necessary safety precautions against electrostatic discharge (ESD) according to EN 61340-5-1 and IEC 61340-5-1.

4.1 Opening and closing the housing

For configuration purposes, the housing must be opened.

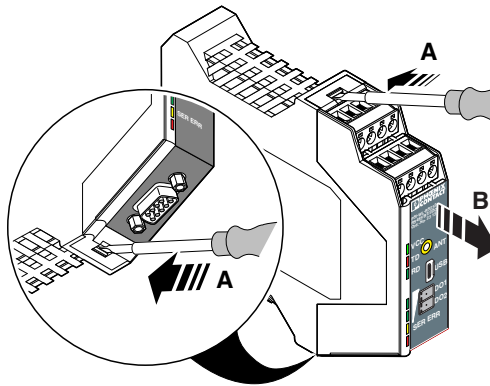

Figure 4-1 Opening the housing

- Open the housing cover using a suitable screwdriver (A)
- Carefully pull the PCB out of the housing as far as possible (B).
- Following configuration, carefully reinsert the PCB as far as it will go.
- Snap the housing cover into place.

4.2 Activating the termination network

The device can be operated on a 2-wire or 4-wire bus line as required. Switchable termination resistors are integrated into the device to terminate the RS-422/RS-485 bus line.

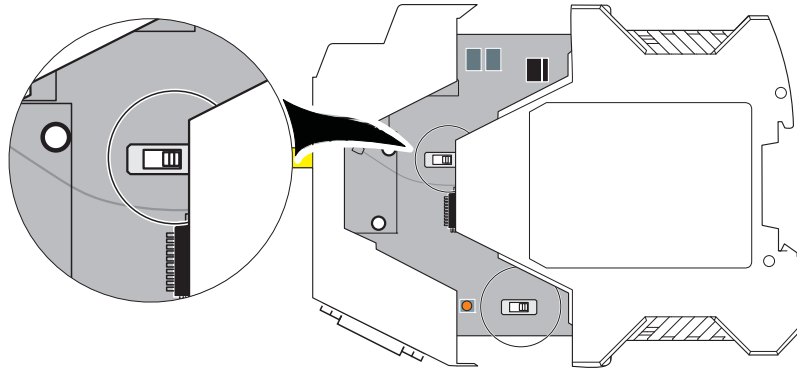

Figure 4-2 Slide switch for termination network

- Depending on the position of the device on the bus line, the termination resistors must be activated or deactivated.
 - **RS-485:** The termination resistors at the two furthest ends of the bus must be activated.
 - **RS-422:** All termination resistors must be activated.

Table 4-1 Slide switch for termination network

Device	Switch position	Termination resistors
RS-422	Left	On
RS-485 termination device	Left	On
RS-485 device	Right	Off

4.3 Setting configuration mode

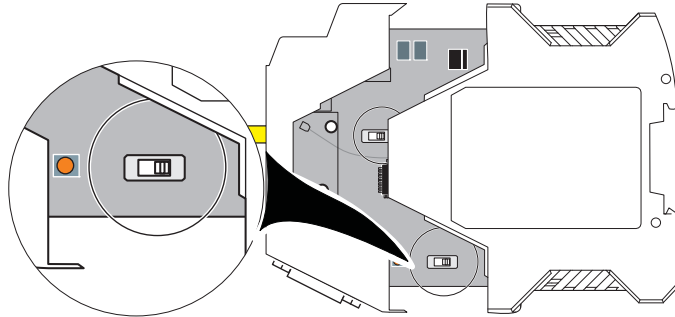

Figure 4-3 CONF/RUN slide switch

- Prior to configuration, set the CONF/RUN slide switch to the CONF position.

Table 4-2 CONF/RUN slide switch

Operating mode	Switch position
CONF	Left
RUN (default setting)	Right

4.4 Resetting to the default settings

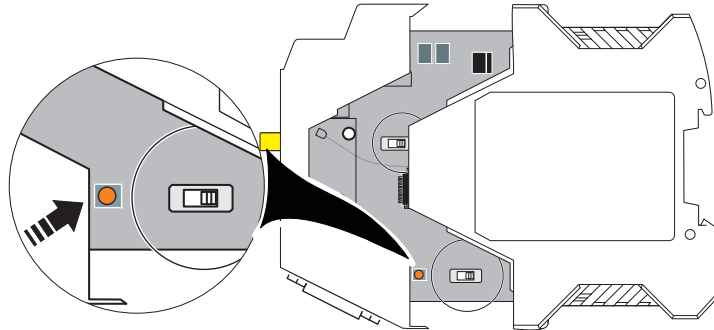

Figure 4-4 Reset button

The reset button can be used to reset the device to the default settings.

Delivery state: 9.6 kbps, no parity, 1 stop bit, hardware handshake



Prior to reset, set the CONF/RUN slide switch to the RUN position.

Do not reset the device during operation, as otherwise configuration data is lost.

- Switch the supply voltage off and open the housing as described in Section “Opening and closing the housing” on page 19.
- Hold the reset button down for approximately three seconds while switching on the supply voltage.

5 Installation and configuration

**CAUTION: Electrical voltage**

The device is only intended for operation in the control cabinet and with SELV according to IEC 60950/EN 60950/VDE 0805. The device may only be connected to devices which meet the requirements of EN 60950.

**NOTE: Malfunction**

Establish an electrically conductive connection between the DIN rail and protective earth ground using a grounding terminal block. The device is grounded when it is snapped onto the DIN rail (installation according to PELV). Make a low-resistance connection to protective earth ground.

5.1 Mounting as single device

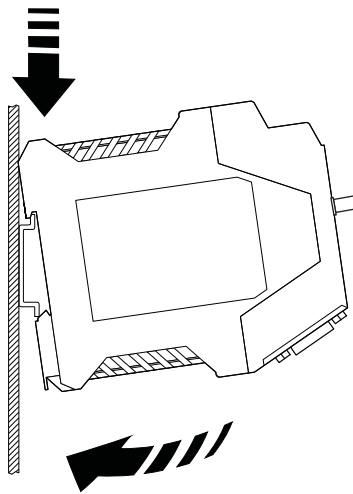

Figure 5-1 Mounting on a DIN rail

- To avoid contact resistance, only use clean, corrosion-free 35 mm DIN rails according to DIN EN 60715.
- Install an end bracket next to the left-hand device to prevent the devices from slipping.
- Place the device onto the DIN rail from above.
- Push the device from the front toward the mounting surface until it engages with a click.

5.2 Combined assembly

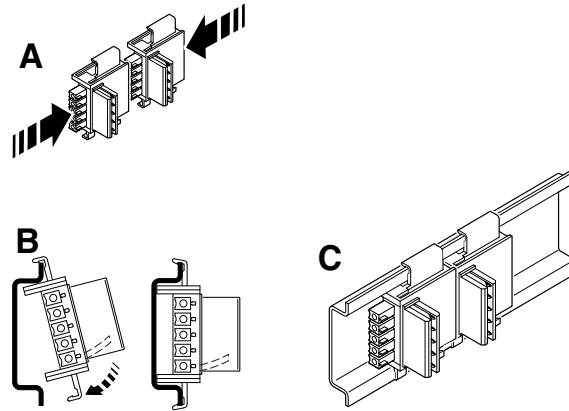

Figure 5-2 Combined assembly

For the modular electronics housing of the ME.../TBUS series, DIN rail connectors of various widths are required in a connection station. The DIN rail connector is used to bridge the power supply and communication.

When using the device in a connection station, use a 22.5 mm wide DIN rail bus connector (Order No. 2707437). Configure two 17.5 mm DIN rail bus connectors for the system power supply unit (e.g., MINI-SYS-PS-100-240AC/24DC/1.5, Order No. 2866983).



NOTE: Device damage

The maximum current load in a connection station must not exceed 2 A.
A connection station must not consist of more than 20 devices.



The snap-in direction of the device and DIN rail connector must be observed: snap-on foot on the bottom and connector on the left.

The device is mechanically secured only via the DIN rail.

- To form a connection station, connect the DIN rail connectors (TBUS) together.
- Push the connected DIN rail connectors onto the DIN rail.
- Place the device onto the DIN rail from above.
- Push the device from the front toward the mounting surface until it engages with a click.

5.3 Removal

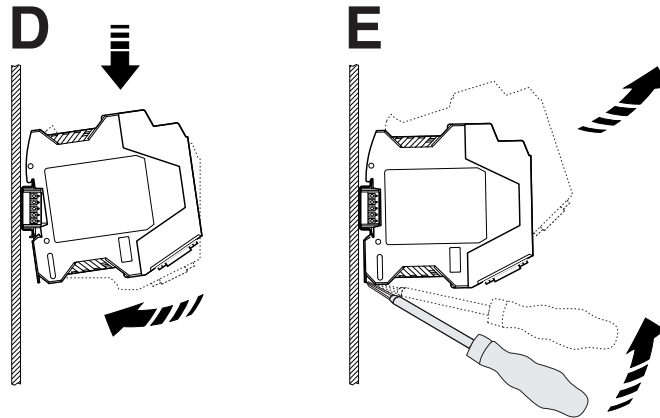

Figure 5-3 Removal

- Push down the locking latch using a screwdriver, needle-nose pliers or similar.
- Slightly pull the bottom edge of the device away from the mounting surface.
- Pull the device diagonally upwards from the DIN rail.
- When removing a complete connection station, also remove the DIN rail connectors.

5.4 Power supply

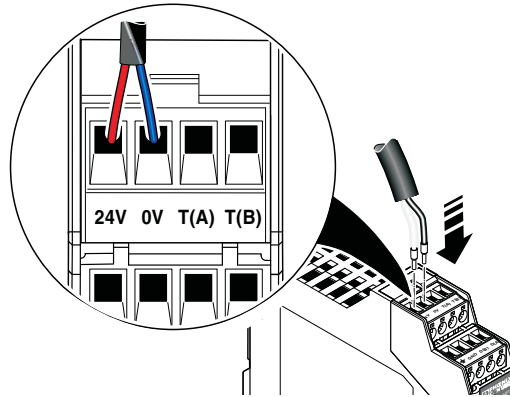

Figure 5-4 Power supply

The device is operated using a 24 V DC SELV.

Operation as a single device

- Supply voltage to the device via the (24 V) and (0 V) terminals.

Operation in a connection station



NOTE: Device damage

The maximum current load in a connection station must not exceed 2 A.
A connection station must not consist of more than twenty devices.

When the devices are operated in a connection station, the supply voltage must only be supplied to the first device in the station. The remaining devices are supplied via the DIN rail connector. A second power supply unit can be used to create a redundant supply concept.

Using the system power supply unit

Alternatively, the connection station can be connected to a system power supply unit.

- Connect the MINI-SYS-PS 100-240AC/24DC/1.5 system power supply unit (Order No. 2866983) using two DIN rail connectors (Order No. 2709561) to the left of the device.

5.5 Serial pin assignments

- Connect the I/O device via the serial interface.

5.5.1 Shielding



NOTE: Damage to the interface

Faulty connection of the shield in combination with permanent external interference can lead to damage of the RS-422/RS-485 interface.

Observe the polarity of the RS-422/RS-485 2-wire cable and correct connection of the shield connection.

- Connect the shield of the RS-422/RS-485 bus line correctly to the device.

5.5.2 RS-232 interface



The RS-232 interface of the device as a DCE (Data Communication Equipment) type.

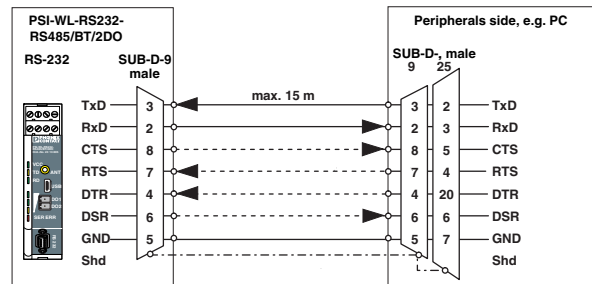

Figure 5-5 RS-232 interface

5.5.3 RS-422 interface

In RS-422 mode, a point-to-point connection can be established. When connecting the I/O device, use a common shielded twisted-pair bus line. Activate the termination resistors on each device (see “Activating the termination network” on page 20).

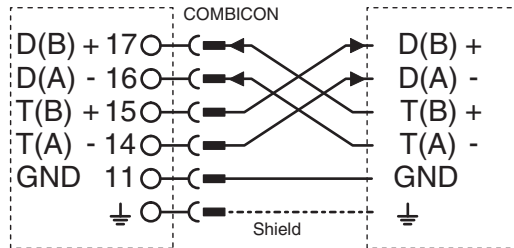

Figure 5-6 RS-422 interface

5.5.4 RS-485 interface

In RS-485 mode, a network with several I/O devices can be created. When connecting the I/O device, use a common shielded twisted-pair bus line. Activate the termination resistors at the two furthest ends of the bus (see “Activating the termination network” on page 20).

- Connect the single wires of the data cable to the COMBICON plug-in screw terminal block. Make sure the signal assignment is correct.

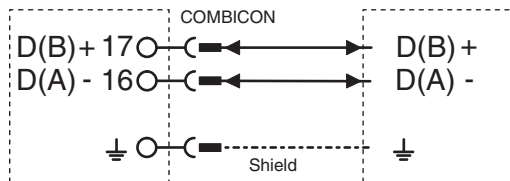

Figure 5-7 RS-485 interface



In a connection station, D(A) and D(B) are output in parallel via the DIN rail connectors.

5.6 Antenna connection

The device is equipped with an MCX socket for connecting an external antenna. A wide selection of antennas and antenna cables can be found in Section “Typical combinations of antennas and adapter cables” on page 75.

Please also observe the notes under “Installing antennas” on page 37 when installing the antenna.

5.7 Diagnostics and status indicators

A 3-stage LED bar graph displays the wireless reception quality during operation.

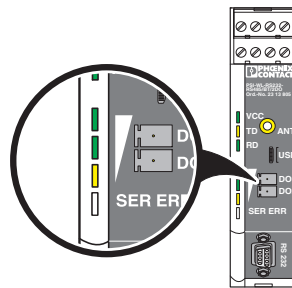

Figure 5-8 Diagnostics indicators during normal operation

Table 5-1 Bar graph

Bar graph	LEDs	Receive signal	DO1	DO2
	All LEDs light up	Wireless signal very good	1	1
	Yellow LED and 1 green LED light up	Wireless signal good	1	0
	Yellow LED lights up	Wireless signal available	0	1
	Off	Not connected	0	0

5.8 Digital diagnostics outputs

Note for the PSI-WL-RS232-RS485/BT/HL product version with HazLoc approval:



WARNING: Explosion hazard when used in potentially explosive areas

Only use digital outputs DO1 and DO2 in the safe area. They are **not** suitable for use in potentially explosive areas.

In addition, the current signal quality can be read via digital outputs DO1/DO2. A coded status of the bar graph LEDs is output here and can be processed externally. The 24 V supply voltage is output via an optocoupler with a maximum current carrying capacity of 120 mA.

Diagnostics outputs

Connection	MINI COMBICON connector, 2-pos., 1.5 mm ² , maximum
Function	Digital output of current Bluetooth receive quality, output of the supply voltage via optocoupler
Maximum current carrying capacity	120 mA
Separate potential levels	VCC // logic
Test voltage	1.5 kV AC, 50 Hz, 1 minute between all potential levels according to EN 50178 and EN 61131-2



For PSI-WL-RS232-RS485/BT/**2DO** and PSI-WL-PROFIB/BT-SET/**2DO** only:
A 2-pos. MINI COMBICON connector (Order No. 1803578) for outputs DO1/DO2 is supplied as standard.

5.9 Configuration

System requirements	Windows operating system, Windows XP or later
Configuration interface	USB, RS-232 or Bluetooth



For configuration, the following is required:

- Serial programming cable PSM-KA9SUB9/BB/2METER, Order No. 2799474
- USB cable PSI-CA-USB A/MINI B/1METER, Order No. 2313575

Configure the device with the PSI-CONF configuration software via the RS-232 or USB interface. Either configure the directly connected device or the device that is connected via Bluetooth.

Delivery state: 9.6 kbps, no parity, 1 stop bit, hardware handshake

- Download the latest PSI-CONF software from the Internet at phoenixcontact.net/products.
- Install the software on your computer.
- Prior to configuration, set the CONF/RUN slide switch to the CONF position (see “Setting configuration mode” on page 21).

6 Application examples

System limitations:

- A PROFIBUS network must only contain one PROFIBUS master at the maximum.
- No other PROFIBUS devices must be connected to the local PROFIBUS master.
- Deactivate the "Commissioning/Test operation" function when using a PROFIBUS CPU as a slave. If this function is activated, the interface becomes an active PROFIBUS device. Multi-master systems are not permitted.
- Observe the following for multi-drop connections: The transmission time increases with the number of Bluetooth devices. Reduce the data rate, if necessary.

Table 6-1 Without termination device addressing (RS-232, RS-422, etc.)



Example	Description	Image
Programming device and PLC	Direct programming connection between a laptop and a programmable logic controller (PLC)	
PDA and PLC	Data links between a third-party device with integrated Bluetooth interface (PDA or cell phone) and an industrial controller	 <p style="text-align: right; font-size: small;">7065B006</p>
PLC and operator interface	Connection between a mobile operator interface and an industrial controller No other PROFIBUS devices must be connected to the local PROFIBUS master.	 <p style="text-align: right; font-size: small;">7065B007</p>

Table 6-2 With termination device addressing (RS-485, 2-wire)

Example	Description	Image
<p>RS-485 2-wire bus system</p>	<p>Integration of a bus device into an existing bus system, e.g., Modbus or PROFIBUS</p> <p>Maximum PROFIBUS data rate: 187.5 kbps</p> <p>PROFIBUS parameters: see Section "Configuring a PROFIBUS connection" on page 79</p>	 <p>7065B009</p>

Table 6-3 Multi-drop connection

Example	Description	Image
<p>1 Bluetooth master/ up to 7 Bluetooth slaves</p>	<p>Networking of automation components. Up to seven Bluetooth slaves can be connected to a Bluetooth master.</p> <p>Multi-master systems are not permitted.</p>	 <p>7065B008</p>

7 Planning wireless systems

7.1 Planning wireless paths

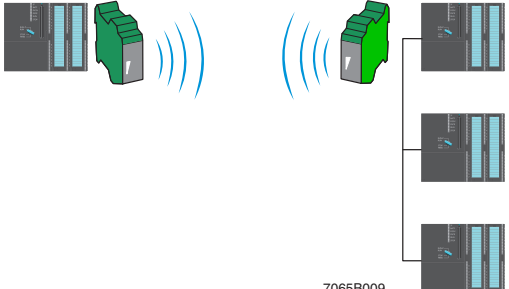
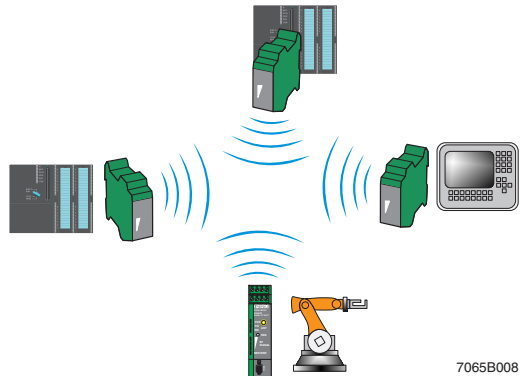
When planning wireless paths over large distances, you need to consider elevation variations. A topographic map or a GPS device are very helpful in this regard. Using GPS devices, you can indicate variations in elevation and measure distances by means of way points. You can use the GPS devices as a direction indicator when later aligning the antennas.

Theoretical planning

The following questions should be taken into account when doing the theoretical planning:

- Which data is to be transmitted?
- What points are the signals to be transmitted between?
- What is the distance between these points?
- Are there any topographic or structural obstacles?
- Are you able to circumnavigate these obstacles, e.g., by means of a higher mast?

When evaluating the data, a system calculation can be carried out to determine whether the wireless path is theoretically possible. A calculation example can be found from page 47.

7.2 Practical test

To check the theoretical results, you should carry out an on-site practical test before purchasing a wireless system. Check the location for the master and slave modules on the basis of the following criteria in order to achieve the optimum wireless connection:

- The antenna is positioned such that a line of sight and sufficient signal strength is ensured.
- A primary power source for energy supply is available.
- Protection of devices against any influences of weather and extreme ambient conditions
- Adequate access to the antenna, surge protection, interface and other required cables

These requirements can be quickly assessed in most applications. However, it is often difficult to position the antenna. Of course, a connection path without any obstacles would be perfect. However, small obstacles in the Fresnel zone will not necessarily disturb communication. In general, obstacles on long wireless paths have a greater influence than on short ones.

7.3 Selecting antenna cables and antennas

Antenna cable

When installing a wireless system, it is very important that you use low-loss coaxial cables. Using an unsuitable cable may lead to considerable loss in performance which can neither be compensated by a high antenna gain nor by high transmission power. For every 3 dB of coaxial cable loss, half the transmission power will be lost before reaching the antenna. The received signal will also be reduced.

Consider the following factors when selecting the cable:

- Cable length to the antenna
- Acceptable signal loss
- Options for routing the cables

Antenna

Table 7-1 Antenna selection

Application	Antenna
Short range and direct line of sight without any obstacles	Small omnidirectional antenna
Medium range	Large omnidirectional antenna (observe the vertical apex angle)
Wide range	Panel antenna (observe the small horizontal apex angle)



For additional information on omnidirectional and panel antennas, please refer to the DB EN WIRELESS ACCESSORIES data sheet. The latest documentation can be downloaded under the product at phoenixcontact.net/products.

7.4 Installing antennas



Please also observe the installation instructions for the antenna as well as Section “For your safety” on page 13.

Observe the maximum permissible emitted transmission power of 20 dBm. The transmission power can be calculated from:

device transmission power + antenna gain - cable attenuation

Reduce the device transmission power, if necessary.

The following recommendations apply to all antenna installations:

- Mount the antenna outside the control cabinet. Observe the installation instructions for the antenna used.
- Install the antenna in an open area as far away as possible from any obstacles such as buildings, dense deciduous forest or metal objects. Choose a location that provides a clear signal path in the direction of the opposite antenna.
- If several antennas are located in the same place, they should have a distance between them of at least 0.6 m in the vertical direction and 1 m in the horizontal direction.
- Pay attention to antenna polarization. Most systems use a vertically polarized omnidirectional antenna at the master station. The opposite antennas must therefore also be polarized vertically. Vertical polarization means that the elements are aligned vertically to the horizon. Crossing polarization between the stations results in a signal loss of 20 dB, minimum.

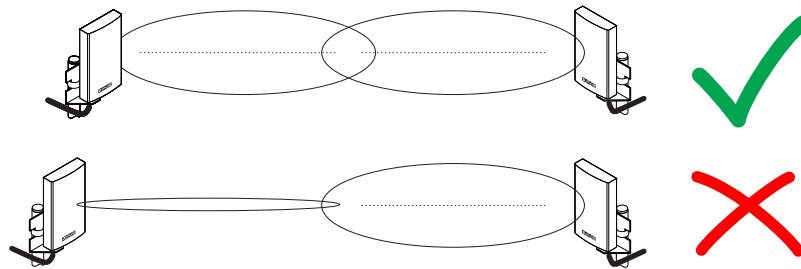

Figure 7-1 Antenna polarization

7.4.1 Aligning panel antennas

- First, align the antennas roughly. Use the following:
 - Topographic map
 - GPS device or compass
 - LED bar graph on the Bluetooth converter

Even if there is no direct line of sight, you can find the alignment point.

- You always have to align both antennas with each other, because the radio waves need to radiate into the antennas.
- In particular with regard to panel antennas, it is important to ensure that the antenna is properly fixed. If the antenna sways in the wind, the transmission or reception beam can move out of its target area.

7.5 Level and attenuation of the Bluetooth converter and accessories

Keep the connection between the Bluetooth converter and the antenna as short as possible. Every extension or adapter cable (pigtail) will cause higher attenuation. A 10 m long RAD-CAB-EF393-10M extension cable results in a loss of 5 dB. The connectors have a typical attenuation of 0.2 dB, i.e., the attenuation value is 0.4 dB + cable length per extension or adapter cable.

You can calculate the levels and attenuation of the Bluetooth converter and accessories using the following table:

Table 7-2 Level

Wireless technology	Bluetooth converter	Connection	Max. power: level at the antenna connection	Can be set to
Bluetooth	PSI-WL-...	MCX (f)	16 dBm	28 ... 14 dBm (in steps of 1 dB)

Table 7-3 Attenuation of accessories

Adapter/cable	Connection	Order No.	Attenuation	Length
Pigtail/adapter - EF316				
RAD-PIG-EF316-MCX-SMA	MCX(m) - SMA(m)	2867678	1.9 dB	1 m
RAD-PIG-EF316-MCX-N	MCX(m) - N(m)	2867681	0.95 dB	0.5 m
RAD-PIG-EF316-N-SMA	N(f) - SMA(m)	2867694	0.57 dB	0.3 m
RAD-PIG-EF316-N-N	N(f) - N(m)	2867704	0.95 dB	0.5 m
RAD-PIG-EF316-SMA-SMA	SMA(m) - SMA(m)	2885618	0.95 dB	0.5 m
Antenna cable - EF393				
RAD-CAB-EF393-3M	N(m)	2867649	1.9 dB	3 m
RAD-CAB-EF393-5M	N(m)	2867652	2.9 dB	5 m
RAD-CAB-EF393-10M	N(m)	2867665	5.4 dB	10 m
RAD-CAB-EF393-15M	N(m)	2885634	7.9 dB	15 m
Adapter				
RAD-ADP-SMA/F-SMA/F	SMA(f) - SMA(f)	2884541	0.3 dB	-
RAD-ADP-N/M-SMA/F	SMA(f) - N(m)	2917036	0.3 dB	-
RAD-ADP-N/F-N/F	N(f) - N(f)	2867843	0.3 dB	-
Surge protection				
CN-LAMBDA/4-5.9-BB	N(f) - N(f)	2838490	0.15 dB	-

Table 7-4 Antenna gain

Antenna	Connec- tion	Order No.	Gain	Remark
Omnidirectional antenna				
RAD-ISM-2400-ANT-OMNI-2-1-RSMA	RSMA(m)	2701362	0 dBi	2.1 dBi - 2.1 dB (1.5 m cable)
RAD-ISM-2400-ANT-VAN-3-1-MCX	MCX(m)	2885702	1.5 dBi	3 dBi - 1.5 dB (1.5 m cable)
Panel antenna				
RAD-ISM-2400-ANT-PAN-8-0	SMA(f)	2867610	8 dBi	
RAD-ISM-2400-ANT-CIR-8-0	SMA(f)	2864936	8 dBi	-
ANT-DIR-2459-01	N(f)	2701186	9 dBi	-
RAD-ISM-2459-ANT-FOOD-6-0	N(f)	2692526	6 dBi	-
RAD-ISM-2400-ANT-OMNI-6-0	N(f)	2885919	6 dBi	-
RAD-ISM-2400-ANT-OMNI-6-0-SW	N(f)	2903219	6 dBi	-
RAD-ISM-2400-ANT-OMNI-9-0	N(f)	2867623	9 dBi	-

7.6 Free space path loss

When using wireless transmission technology, the signal between transmitter and receiver is attenuated by the air. The following table lists attenuation values for different distances with a free Fresnel zone and 2.4 GHz.

Table 7-5 Free space path loss

Distance	Attenuation
5 m	54 dB
10 m	60 dB
20 m	66 dB
30 m	69.5 dB
50 m	74 dB
100 m	80 dB
110 m	80.8 dB
120 m	81.6 dB
150 m	83.5 dB
200 m	86 dB
250 m	88 dB
300 m	89.5 dB
350 m	90.9 dB
400 m	92 dB
450 m	93.1 dB
500 m	94 dB
550 m	94.8 dB
600 m	95.6 dB
650 m	96.3 dB
700 m	96.9 dB
750 m	97.5 dB
800 m	98.1 dB
850 m	98.6 dB
900 m	99.1 dB
950 m	99.6 dB
1000 m	100 dB

General formula: **free space path loss [dB] = 32.4 + 20 x log(f) + 20 x log(d)**

Formula at 2.4 GHz: **free space loss path [dB] = 100 + 20 x log(d)**

f = transmission frequency in MHz

d = distance between the antennas in km

The free space path loss is later included in the system calculation (see Section “Equivalent isotropically radiated power (EIRP)” on page 47).

7.7 Propagation of radio waves

In addition to the free space path loss, there are other factors which influence the wireless path. Dispersion, diffraction, and reflection represent types of interference that occur when the wireless signal encounters obstacles. They result in multipath propagation.

Dispersion

The dispersion of the wireless signal (e.g., at a tree) means that the wireless signal is dispersed in several directions. A tree without any leaves virtually allows all signals to completely pass through, whereas a tree with foliage results in a considerable degree of dispersion. The leaf surfaces disperse the wireless signal in many different directions.

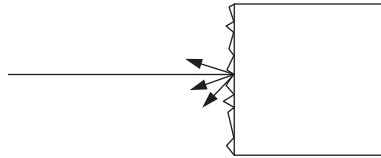

Figure 7-2 Dispersion on a rough surface

Diffraction

Diffraction of the wireless signal, e.g., on edges and obstacles, involves the signal being refracted around the edge. The signal then changes its direction. This is similar to the refraction of light in a crystal.

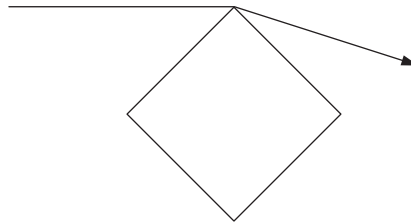

Figure 7-3 Diffraction on an edge

Reflection

Reflection on a smooth metal surface involves virtually the entire wireless signal being reflected at the same angle. In certain applications, the reflection may have a positive effect (e.g., if there is no line of sight). Reflections mainly occur in buildings.

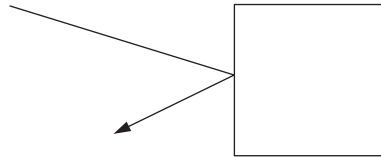

Figure 7-4 Reflection on a metal surface

Penetration

The type of wall encountered also influences the attenuation of the wireless signal. The following constructions adversely affect the wireless signal, for example:

- Hollow lightweight walls with aluminum-lined insulation
- False ceilings with metal or carbon fiber panels
- Lead glass
- Insulation glass (Thermopen)
- Glass with a metal coating
- Steel objects
- Fire walls
- Elevator shafts and staircases

Each material has a different degree of attenuation. However, the following typical values provide a rough orientation.

Table 7-6 Attenuation with regard to different materials

Obstacle	Typical attenuation at 2.4 GHz [dB]
Thin wall	2 ... 5
Wooden wall	5
Brick wall	6 ... 12
Concrete wall	10 ... 20
Concrete ceiling	20
Elevator	20 ... 30

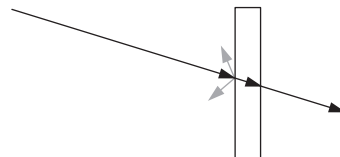

Figure 7-5 Reduction of radio waves when penetrating a wall

Also observe the angle between transmitter and receiver. Depending on the angle, the radio waves have to penetrate more or less material.

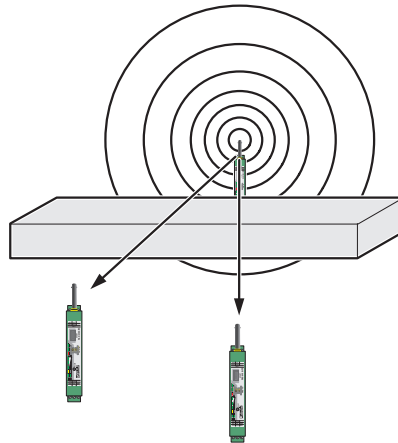

Figure 7-6 Angle of the transmitter and receiver

Radio dead spot

Radio dead spots are caused by impenetrable obstacles in the wireless path. The radio dead spot can be compared to the shadow cast by the sun. If the receiver is located in a radio dead spot, no direct radio waves can reach it, but it can only receive reflections or diffracted waves.

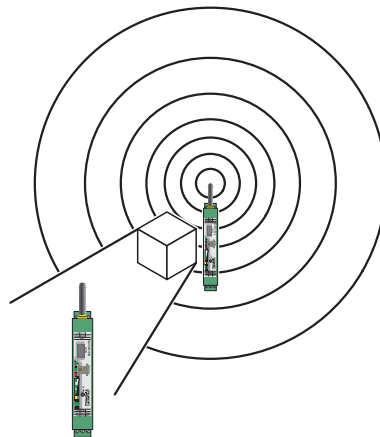

Figure 7-7 Radio dead spot

Weather influences

Snow, rain or hail only have a small effect on the wireless signal in the 2.4 GHz range.

Heavy rain, for example, only has a minimal effect on the wireless signal. With a rainfall of 50 liters per square meter, i.e., a cloudburst, attenuation of around 0.02 dB/km occurs at a frequency of 2.4 GHz.

Strong wind does not influence the wireless signal, however, it places high requirements on the secure fixing of the antenna. In particular when using panel antennas with a small apex angle, you should ensure that the antenna cannot be shifted by the wind. If the antenna is moved by just 1 cm from its original position, this may result in a partial loss of the wireless signal, especially in the case of a long transmission path.

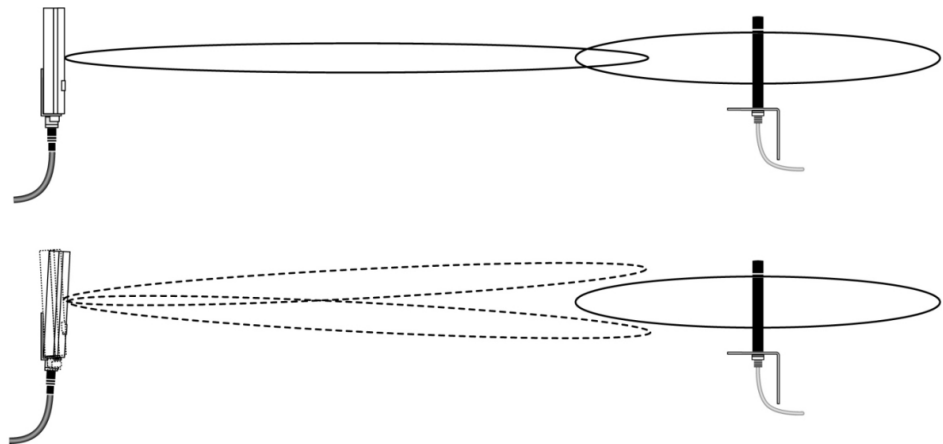

Figure 7-8 Wireless path with strong wind

7.8 Fresnel zone

A certain area between the transmitting and receiving antennas on the wireless path is referred to as the Fresnel zone. There should be a line of sight, especially in the event of longer distances, between the antennas. To adhere to the Fresnel zone, it might be required to install the antennas at a height of a few meters. This area should also be free from any other obstacles.

The ideal wireless path with a direct line of sight between transmitter and receiver is not always possible. In applications, obstacles that affect the wireless channel often have to be taken into account. The wireless path may also work if obstacles (house, tree, etc.) are within the Fresnel zone. The decisive factor is the number of obstacles and the area they occupy in the Fresnel zone. In this case, test measurements should be carried out.

Inside buildings, e.g., in conventional automation environments, there is a predominance of reflections. They contribute to a good wireless connection even if the Fresnel zone is not free from obstacles.

The following figure shows the Fresnel zone between two antennas. The required mounting height for the antennas depends on the radius of the Fresnel zone.

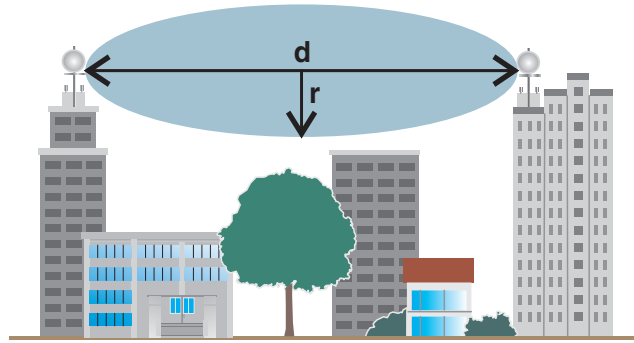

Figure 7-9 Fresnel zone

Table 7-7 Radius of the Fresnel zone depending on the distance

Wireless path distance (d)	Radius of the Fresnel zone (r) at 2.4 GHz
50 m	1.3 m
100 m	1.8 m
150 m	2.2 m

General formula for calculating the diameter of the Fresnel zone:

$$r = 0.5 \times \sqrt{\lambda \times d}$$

r = radius of the Fresnel zone

λ = wavelength (0.125 m at 2.4 GHz)

d = distance between the antennas in km

Radius of the Fresnel zone with d = 100 m:

$$r = 1.8 \text{ m}$$

Result: The radius of the Fresnel zone is 1.8 m at a wavelength of 0.125 m (2.4 GHz) and a distance of 100 m between the antennas.

7.9 Range

It is very difficult to specify a range due to the influence of various factors. Based on practical tests, it is possible to provide guide values. They may be clearly higher or lower depending on the actual application:

The range depends on the following:

- Antenna cable length
- Antenna used

Table 7-8 Ranges for different antennas

Antenna	Range [m]
Inside buildings	
2 dBi omnidirectional antenna	< 50
Outside buildings, with a free line of sight	
2 dBi omnidirectional antenna	< 50
6 dBi omnidirectional antenna	< 150
8 dBi or 9 dBi panel antenna	< 150

7.10 Equivalent isotropically radiated power (EIRP)

The equivalent isotropically radiated power (EIRP) is a gauge of the radiation power of an antenna. The EIRP value is the sum of the transmission power in dBm and the antenna gain in dBi.

Example:

- Transmission power = 14 dBm
- Antenna gain = 8 dBi
- Attenuation by a 3 m long cable = 2.85 dB

- $EIRP = 14 + 8 - 2.85 \text{ dBm} = 19.15 \text{ dBm}$

7.11 System calculation in free space

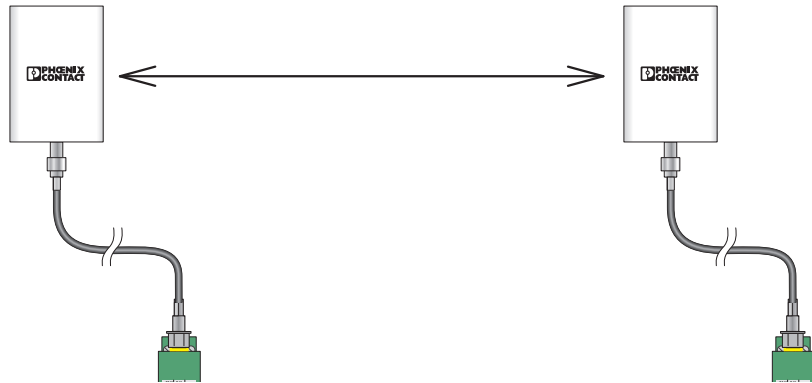

Figure 7-10 Free space path loss

Antenna gain per antenna: 8 dBi

Transmission power per Bluetooth converter: 14 dBm

Cable attenuation per cable (3 m EF 142): 2.85 dB

Free space path loss 150 m: 83.5 dB

Example calculation with optimum free space

- Wireless technology: Bluetooth
- Wireless path length: 150 m
- Device transmission power + antenna gain - cable attenuation (EIRP): ≤ 20 dBm
(20 dBm must not be exceeded for legal reasons; adapt the cable, adapter or transmission power, if required)

EIRP [dBm] =
transmitter power [dBm]
+ gain of transmitting antennas [dBi]
- losses of the transmitter cable [dB]

Incoming power for the receiver [dBm] =
transmitter power [dBm]
- losses of the transmitter cable [dB]
+ gain of the transmitting antenna [dBi]
- free space path loss [dB]
+ gain of the receiving antenna [dBi]
- attenuation of the antenna cable at the receiver [dBm]

System reserve =
receiver sensitivity [dBm]
- incoming power for the receiver [dBm]
(recommended system reserve >10 dB)

EIRP = 19.15 dBm

Free space path loss [dB] =
 $32.4 + 20 \log(f[\text{MHz}]) + 20 \log(R[\text{km}]) = 32.4 + 20 \log(2400) + 20 \log(0.2) = 83.5$ dB

Incoming power for the receiver = -67.7 dBm

Receiver sensitivity = -91 dB

System reserve = 91 dB - 67.7 dB = 23.3 dB

7.12 Practical examples

It is not possible to provide basic calculation principles for obstacles in the wireless path as the obstacles and applications will vary too much. The practical examples given below are for guidance only and cannot be directly transferred to other applications.

Bushes

The bush illustrated below is two meters wide and has an attenuation of approximately 15 dB.



Figure 7-11 Bush with an attenuation of approximately 15 dB

Forest

The forest illustrated below consists of dense undergrowth with a trunk diameter of approximately 5 to 20 centimeters. In our test, the wireless signal was transmitted through a 25 m forest. The attenuation was about 40 dB.



Figure 7-12 Forest with an attenuation of about 40 dB

8 Detecting and removing errors

If your wireless system does not function properly, proceed as follows:

- First, ensure that you have a good wireless signal with two green bar graph LEDs.



Avoid contact between the antennas of two Bluetooth converters, otherwise the receiver might become overloaded.

Ground loops are caused by grounding of the antenna via the antenna fixing unit, grounding of the power supply, or grounding of the serial interface. To avoid ground loops, connect these components to a single ground point.

8.1 Loopback test during serial data transmission

With an RS-232 interface, you can use the loopback test to check the data path from the master to the slave and back again. To do so, short-circuit two terminal points of the RS-232 interface on the slave Bluetooth converter. It is then possible to transmit characters to the master Bluetooth converter using a terminal program (e.g., HyperTerminal). The characters are echoed back to the terminal program.



Note for Windows 7 users:

HyperTerminal is no longer available in Windows 7. Instead you can use any other terminal program.

To carry out a loopback test, proceed as follows:

- Close all programs on your PC, including the PSI-CONF software.
- Connect the PC to the master Bluetooth converter and start HyperTerminal via “Start, All Programs, Accessories, Communication, HyperTerminal”. The COM port settings on the PC must correspond to the interface settings on the master Bluetooth converter.
- Insert a loopback test connector onto the RS-232 interface of the slave Bluetooth converter.

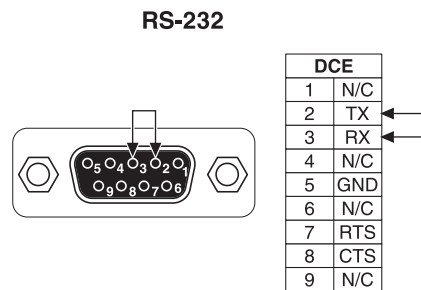

Figure 8-1 Loopback test on an RS-232 interface

- Connect both Bluetooth converters to the power supply.
- Check the wireless connection via the LED bar graph.
- Enter several characters of your choice. HyperTerminal transmits these characters over the wireless path. On the slave side, the characters are output and immediately read again using the bridge. This returns the already transmitted characters and they appear twice on the HyperTerminal screen.
 - The screen remains blank if the check was not successful. Monitor the TX and RX LEDs on every Bluetooth converter. You can thereby determine the point up to which data has been transmitted.
 - In case the characters only appear once, check the HyperTerminal settings for hidden outgoing characters. The following options must be enabled under “File, Properties, Settings, ASCII Setup”:
“Echo typed characters locally” and
“Append line feeds to incoming line ends”

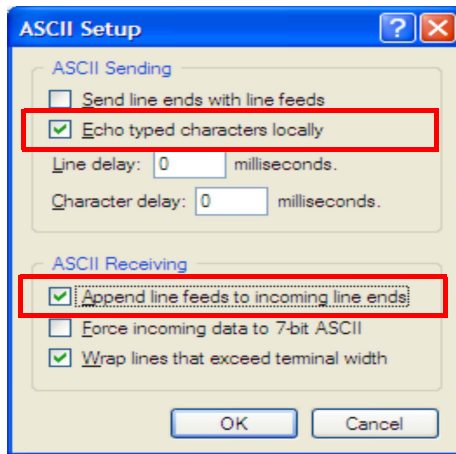

Figure 8-2 Settings in HyperTerminal

9 AT commands

The Bluetooth converter stores its operating characteristics in a non-volatile memory (EEPROM). You can overwrite these characteristics using commands and can thus modify the method of operation of the device. The device executes commands as long as it is in command mode.

You can enter commands for the Bluetooth converter using appropriate communication software (e.g., HyperTerminal).



Make sure that the baud rate setting for the COM port in your communication software corresponds to the set speed of the Bluetooth converter.

If the CONF/RUN slide switch is in the “CONF” position, the interface is always set to RS-232, 57.6 kbps, 8 data bits, no parity, 1 stop bit, and hardware handshake.

Switching to command mode

The device is directly in data mode when it is switched on.

- Enter the Escape string (default: **+++**) to access command mode. Command mode is used to configure the Bluetooth converter.



An interval of at least one second must be observed before and after sending the Escape string. The Escape string must be entered **within one second**.

Intervals can be set using the **AT*AMET** command. The Escape string can be modified using the **ATS2** command.

- Enter **AT*ADDM** to return to data mode once configuration is complete and confirm by pressing ENTER. The device only transmits data to the partner once it is in data mode.

Command structure

All commands transmitted to the Bluetooth converter must start with **AT** and must be confirmed by pressing ENTER. The commands can be entered in upper case or lower case, however, not in a combination of both. Unlike a modem, several commands cannot be written in one command line.



AT deletes the last command line executed by your Bluetooth converter (if present) and prepares your device for the new command line.

Correcting a typing error

When entering a wrong command character, it can be corrected using the backspace key. Pressing the backspace key deletes the character entered last. However, **AT** at the start of the command line will not be deleted.

9.1 Command descriptions

AT**Attention string**

AT is the prefix of a command line and must be entered at the start of each command line (except for the +++ Escape string).

Entry of **AT** without a subsequent command line is confirmed by the Bluetooth converter with OK.



If you attempt to execute a command line that is unknown or does not start with **AT**, an ERROR message is generated (except for the +++ Escape string).

AT***Command list**

The **AT*** command is used to display a list of supported AT commands.

E**Echo**

The Bluetooth converter is set by default to display commands on the PC screen in command mode (echo). This feature can only be used if your PC is configured for full duplex mode.



Most systems operate in full duplex mode. In this case, you can activate the echo function using the **E1** command.

If you are working in half duplex mode, disable the echo function with the **E0** command.

S2**Escape string**

This command specifies the ASCII value of the Escape character.

Default setting: 43 (This value corresponds to ASCII character "+").

Example: **ATS2=43**

Z**Dummy command**

The **ATZ** command has no function. However, it is used by some controllers to determine whether a modem is connected to the interface. Therefore, the Bluetooth converter responds to an **ATZ** with "OK".

&F**Factory configuration**

The **AT&F** command restores the factory settings. The factory settings can be modified using the **AT*AMSF** command.

9.2 Connection commands

*AGDM

Detection mode

The ***AGDM** command permits or prohibits other Bluetooth devices from finding your Bluetooth converter.

? Request

The current detection mode is displayed.

1,x Undiscoverable

- Other Bluetooth devices **cannot** find the Bluetooth converter when performing a search.
- Other Bluetooth devices **cannot** be connected to the Bluetooth converter.

2,x Discoverable but connectable

- Other Bluetooth devices **cannot** find the Bluetooth converter when performing a search.
- Other Bluetooth devices can be connected to the Bluetooth converter.

3,x Discoverable and connectable

- Other Bluetooth devices can find the Bluetooth converter when performing a search.
- Other Bluetooth devices can be connected to the Bluetooth converter.

x = 0 -> The setting is only valid until the next voltage interrupt.

x = 1 -> The setting is stored.

Example: **AT*AGDM=3,1**

“Discoverable and connectable” detection mode is set and stored.

AGCM*Connection mode**

The ***AGCM** command specifies the connection option.

? Request

The current connection mode is displayed.

1,x Connection not permitted

Other Bluetooth devices **cannot** be connected to the Bluetooth converter.

2,x Connection permitted

Other Bluetooth devices can be connected to the Bluetooth converter.

x = 0 -> The setting is only valid until the next voltage interrupt.

x = 1 -> The setting is stored.

Example: **AT*AGCM=2,1**

"Connection permitted" connection mode is set and stored.

AGPM*Pairing mode**

The ***AGPM** command specifies the pairing option.

? Request

The current pairing mode is displayed.

1,x Pairing not permitted

Other Bluetooth devices **cannot** be paired with the Bluetooth converter.

2,x Pairing permitted

Other Bluetooth devices can be paired with the Bluetooth converter.

x = 0 -> The setting is only valid until the next voltage interrupt.

x = 1 -> The setting is stored.

Example: **AT*AGPM=1,0**

"Pairing not permitted" connection mode is set but not stored.

***AGSM**

Security mode

The ***AGSM** command specifies the security option.

? Request

The current security mode is displayed.

1,x Security disabled

Bluetooth security mode 1: data encryption disabled, no connection authentication required.

2,x Security enabled

Bluetooth security mode 3: data encryption enabled and connection authentication required.

x = 0 -> The setting is only valid until the next voltage interrupt.

x = 1 -> The setting is stored.

Example: **AT*AGSM=2,1**

“Security enabled” connection mode is set and stored.



Pairing and an identical password for the relevant Bluetooth devices are essential in order to establish a data connection when security is enabled.

***AGND**

Name request

The ***AGND** command requests the Bluetooth device name of a partner. The Bluetooth address of the partner must be known.

Example: **AT*AGND=0080371DA128**

The partner has the address: 0080371DA128

AGDD*Device search**

The ***AGDD** command searches for Bluetooth devices.

1,x Limited request

2,x Standard request

x = specification time

x specifies the length of the search.

Value range: 8 ... 48 (times 1.28 = seconds)

Example: **AT*AGDD=2,10**

A standard search of 12.8 seconds is started.

Feedback:

***AGDD:a**

OK

***AGDDE:w, x, y, z**

a Number of Bluetooth devices found

w Bluetooth address

x Device class (see COD)

y – y = 0 -> Device name not available

– y = 1 -> Device name available

z Device name

AGI*Request**

The ***AGI** command requests the Bluetooth devices in the area.

1,x,y Limited request

2,x,y Standard request

x Specification time

x specifies the length of the search.

Value range: 8 ... 48 (times 1.28 = seconds)

y Number

Maximum number of Bluetooth devices to be found

Value range: 1 ... 255 (0 = no limit to the number)

Example: **AT*AGI=2,10,5**

A standard search of 12.8 seconds for a maximum of five devices is started.

Feedback:

***AGI:Bluetooth address, device class**

(repeated accordingly for all devices found)

***AGB**

Pairing

The ***AGB** command pairs the Bluetooth converter with the partner.

Example: **AT*AGB=0080371DA128**

The partner has the address: 0080371DA128



The partner must accept pairing (see ***AGPM** pairing mode) and both devices must have the same password.

***AGUB**

Unpairing

The ***AGUB** command unpairs the Bluetooth converter from the partner.

Example: **AT*AGUB=0080371DA128**

The partner has the address: 0080371DA128

***AGBD?**

Requesting the paired devices

The ***AGBD?** command reads the list of paired Bluetooth partners from the Bluetooth converter.

Example: **AT*AGBD?**

Feedback:

***AGBD:a**

OK

***AGBDE:x, y, z**

a **Number of paired Bluetooth devices**

x **Bluetooth address**

y - y = 0 -> Device name not available

 - y = 1 -> Device name available

z **Device name**

***AGFP**

Password

The ***AGFP** command is used to read and write the password of your Bluetooth converter.

? Request

The current password is requested.

PW,x Write password

“PW” must not exceed 16 characters.

x = 0 -> The setting is only valid until the next voltage interrupt.

x = 1 -> The setting is stored.

Example: **AT*AGFP=4711,1**

Password “4711” is written to the Bluetooth converter and stored.

AGLN*Individual name**

The ***AGLN** command is used to read and write the name of the Bluetooth converter.

? Request

The current Bluetooth name is requested.

N,x Write name

“N” must not exceed 240 characters (umlauts are not permitted).

x = 0 -> The setting is only valid until the next voltage interrupt.

x = 1 -> The setting is stored.

Example: **AT*AGLN=Packaging machine,1**

The name “Packaging machine” is written to the Bluetooth converter and stored.

AGLC*Individual device class (COD)**

The ***AGLC** command is used to read and specify the device class of the Bluetooth converter.

? Request

The individual device class (COD - Code of Device) is requested.

C,x Specify device class

x = 0 -> The setting is only valid until the next voltage interrupt.

x = 1 -> The setting is stored.

AGGMSR*Read client/server role**

The ***AGGMSR** command reads the client/server role of the partner.

Example: **AT*AGGMSR=0080371DA128**

The partner has the address: 0080371DA128

Feedback:

***AGGMSR:x**

x = 0 The partner is a server.

x = 1 The partner is a client.

AGCMSR*Specify the client/server role**

The ***AGCMSR** command specifies the client/server role of the partner.

Example: **AT*AGCMSR=0080371DA128,x**

The partner has the address: 0080371DA128

x = 0 The partner is a server.

x = 1 The partner is a client.

***AGMSP**

Client/server method

The ***AGMSP** command specifies the individual client/server method of the Bluetooth converter.

? Request

The current client/server method is displayed.

1,x Partner may choose

The partner may decide whether it would like to be a client or a server.

0,x Client

Your device always attempts to be a client (partner always a server).

x = 0 -> The setting is only valid until the next voltage interrupt.

x = 1 -> The setting is stored.

Example: **AT*AGMSP=1,1**

The "partner may choose" method is set and stored.

***AGRSS**

Signal strength

The ***AGRSS** command requests the received signal strength from a partner. The Bluetooth address of the partner must be known.

Example: **AT*AGRSS=0080371DA128**

The partner has the address: 0080371DA128

Feedback:

***AGRSS:128**

(128 = optimum signal strength)



For this request, the Bluetooth converter must have already established a data link with the partner but still be in command mode.

9.3 Reading the service profile



The service profile does not have to be read in “normal” applications. This section is therefore only aimed at users with well-established knowledge of Bluetooth.

*ARSS

Request the Bluetooth service profile

The *ARSS command reads the Bluetooth service profile of the Bluetooth partner.

AT*ARSS=*x,y,z*

x Bluetooth address

The Bluetooth address of the opposite station is displayed.

y Bluetooth service profile

- y = 0 -> Serial port profile
- y = 1 -> Dial-up networking profile
- y = 2 -> LAN access profile

z Maximum number of results

The maximum number of search results is specified.

Feedback for “Serial port profile”:

ARSS:*N

OK

ARSRSP:*A,B,C,D

N Number of services found

A Bluetooth address

The Bluetooth address of the opposite station is displayed.

B RFCOMM server channel

Number of the RFCOMM server channel on which the service was found (value range: 1 ... 30)

C Service name

- C = 0 -> Service name not available
- C = 1 -> Service name available

D Name of the service found

The name of the service found is displayed.

Feedback for “Dial-up networking profile”:

ARSS:*N

OK

ARSRDUN:*A,B,C,D,E,F

N Number of services found

A Bluetooth address

The Bluetooth address of the opposite station is displayed.

B RFCOMM server channel

Number of the RFCOMM server channel on which the service was found (value range: 1 ... 30)

C Service name available?

- C = 0 -> Service name not available and "D" is invalid.
- C = 1 -> Service name available and "D" is valid.

D Name of the service found

The name of the service found is displayed.

E Information about audio feedback available?

- E = 0 -> Information about audio feedback is not available and "F" is invalid.
- E = 1 -> Information about audio feedback is available and "F" is valid.

F Audio feedback



The "Audio feedback" function is not supported by the Bluetooth converter.

Feedback for "LAN access profile":

*ARSS:*N*

OK

*ARSRLAN:*A, B, C, D, G, H, I, J, K, L*

N Number of services found

A Bluetooth address

The Bluetooth address of the opposite station is displayed.

B RFCOMM server channel

Number of the RFCOMM server channel on which the service was found (value range: 1 ... 30)

C Service name available?

- C = 0 -> Service name not available and "D" is invalid.
- C = 1 -> Service name available and "D" is valid.

D Name of the service found

The name of the service found is displayed.

G Service description available?

- G = 0 -> A service description is not available and "H" is invalid.
- G = 1 -> A service description is available and "H" is valid.

H Service description

I Service parameter available?

- I = 0 -> A service parameter is not available and "J" is invalid.
- I = 1 -> A service parameter is available and "J" is valid.

J Service parameter

K Subnet IP available?

- K = 0 -> A subnet IP address is not available and "L" is invalid.
- K = 1 -> A subnet IP address is available and "L" is valid.

L Subnet IP

Subnet IP address, under which the partner can be reached in the LAN network.

9.4 Data mode

*ADDM

Data mode

The ***ADDM** command switches the Bluetooth converter from command to data mode.

*ADCP

Establish a serial data connection

The ***ADCP** command establishes a serial data connection to the partner.

AT*ADCP=A,x,y,z

A Bluetooth address

The Bluetooth address of the partner is displayed.

x Bluetooth service profile

- x = 0 -> Serial port profile
- x = 1 -> Dial-up networking profile
- x = 2 -> LAN access profile

y RFCOMM server channel

“0” can be entered for automatic selection. Experienced users can select a channel between 1 and 30.

- #### z
- z = 0 -> The partner decides whether it is a client or a server.
 - z = 1 -> The Bluetooth converter becomes the client.

Feedback:

AT*ADCP:K

K Connection ID

ID of the current connection. This ID is required to interrupt the connection using the ***ADCC** command.

*ADCC

Interrupt the serial data connection

The ***ADCC** command interrupts a serial data connection to the partner.

AT*ADCC=K

K Connection ID

The ID of the connection to be interrupted. This ID was displayed when the connection was established (***ADCP**).

If there is only one connection, this is displayed as “1”.

***ADDCP**

Standard client profile

The ***ADDCP** command specifies the standard client profile of the Bluetooth converter.

? Request

The standard client profile is displayed.

=0,x Serial port profile

=1,x Dial-up networking profile

=2,x LAN access profile

=255,x No profile

x = 0 -> The setting is only valid until the next voltage interrupt.

x = 1 -> The setting is stored.

Example: **AT*ADDCP=0,1**

The serial port profile is set and stored as the standard client profile.

***ADDSP**

Standard server profile

The ***ADDSP** command specifies the standard server profile of the Bluetooth converter.

? Request

The standard client profile is displayed.

=0,x Serial port profile

=1,x Dial-up networking profile

=2,x LAN access profile

=255,x No profile

x = 0 -> The setting is only valid until the next voltage interrupt.

x = 1 -> The setting is stored.

Example: **AT*ADDSP=0,1**

The serial port profile is set and stored as the standard server profile.

ADMRP*Maximum number of partners**

The ***ADMRP** command requests the maximum possible number of partners of the Bluetooth converter.

? Request

The maximum number of partners is displayed.

Feedback:

***ADMRP:7**

The Bluetooth converter can communicate with a maximum of seven slaves.

ADNRP*Number of partners**

The ***ADNRP** command specifies the number of partners. If your device is not to act as the master, enter "0".

? Request

The maximum number of partners is displayed.

=a,x a = Number of partners

x = 0 -> The setting is only valid until the next voltage interrupt.

x = 1 -> The setting is stored.

Example: **AT*ADNRP=2,1**

Two partners are set and stored.



The number of partners (***ADMRP**) must not exceed the maximum number of partners (***ADNRP**).

ADWDRP*Standard partner**

The ***ADWDRP** command specifies the standard partners.

a Partner ID

“a” is between “0” and “Number of partners - 1”

b Bluetooth address**c Connection scheme**

- c = 1 -> The connection to the partner is established in the event of data traffic.
- c = 2 -> The connection is established as soon as your device is in data mode.
- c = 3 -> The connection to the partner is established in the event of data traffic or as soon as the device is in data mode.

d Partner update

- d = 0 -> The partner is not updated automatically.
- d = 1 -> A new device that connects to your device is automatically added and stored in the address list. This function is only available for a partner.

e,x Device name

The Bluetooth device name is displayed (240 characters, maximum).

- x = 0 -> The setting is only valid until the next voltage interrupt.
- x = 1 -> The setting is stored.

Partner specification:

AT*ADWDRP=a, b, c, d, e, x

Partner request:

Example: **AT*ADWDRP=a**

Feedback:

***ADWDRP:b, c, d, e**

ADIT*Inactivity timer**

The ***ADIT** command determines the automatic shutdown time in the event of inactive data traffic.

? Request

The shutdown time is displayed.

=a,x a = shutdown time in minutes (255, maximum)

- a = 0 -> No automatic shutdown
- x = 0 -> The setting is only valid until the next voltage interrupt.
- x = 1 -> The setting is stored.

Example: **AT*ADIT=10,1**

If there is no data flow after ten minutes, the connection is interrupted. This setting is stored.

ADWM*Multi-drop configuration**

The ***ADWM** command activates or deactivates the “Wireless multi-drop” function. In multi-drop operation, the master sends its serial data to all the slaves. The multi-drop function on slaves must always be deactivated (only the master is configured for multi-drop). If the multi-drop function of the master is deactivated, it is only possible to connect to one slave.

? Request

The multi-drop function is displayed.

a Multi-drop active

- a = 0 -> Multi-drop deactivated
- a = 1 -> Multi-drop activated

b Forwarding

- b = 0 -> The data received by a master is only forwarded to the serial interface.
- b = 1 -> The data received by a master is forwarded to all other connected slaves and to the serial interface.



The “Forwarding” function is not supported by the Bluetooth converter.

- x** - x = 0 -> The setting is only valid until the next voltage interrupt.
- x = 1 -> The setting is stored.

AT*ADWM=a, b, x

Example: **AT*ADWM=1,0,1**

Multi-drop is activated and the data received by a master is only forwarded to the serial interface. This setting is stored.

Request: **AT*ADWM?**

Feedback:

***ADWM:a, b**

9.5 Information commands

AILBA*Bluetooth address**

The ***AILBA** command requests the individual local Bluetooth address of the Bluetooth converter.

? Request

The individual local Bluetooth address is displayed.

9.6 Interface commands

*AMRS

RS-232 settings

The ***AMRS** command sets the parameters of your RS-232 interface. These settings are also used for the RS-485 and RS-422 interfaces.

? Request

The interface parameters are displayed.

a Transmission speed

Standard

- a = 2 -> 1200 bps
- a = 3 -> 2400 bps
- a = 4 -> 4800 bps
- a = 5 -> 9600 bps
- a = 6 -> 19200 bps
- a = 7 -> 38400 bps
- a = 8 -> 57600 bps
- a = 9 -> 115200 bps

Special

- a = 17 -> 7200 bps
- a = 18 -> 31250 bps
- a = 19 -> 75000 bps
- a = 20 -> 93750 bps
- a = 21 -> 136000 bps
- a = 22 -> 187500 bps

b Data bits

- b = 1 -> 8 data bits

c Stop bits

- c = 1 -> 1 stop bit
- c = 2 -> 2 stop bits

d Parity

- d = 1 -> None
- d = 2 -> Odd
- d = 3 -> Even

e Flow control

- e = 1 -> RTS/CTS
- e = 2 -> None

f Update settings

- f = 0 -> Following the next voltage interrupt
- f = 1 -> Immediately (after confirming by pressing ENTER)

x

- x = 0 -> The setting is only valid until the next voltage interrupt.
- x = 1 -> The setting is stored.

AT*AMRS=a, b, c, d, e, f, x

Example: **AT*AMRS=5,1,1,3,1,1,1**

The interface is set to 9.6 kbps, 8 data bits, 1 stop bit, even parity, and RTS/CTS flow control. This setting is accepted and stored immediately.

Request: **AT*AMRS?**

Feedback:

***AMRS:a, b, c, d, e**

***AMSIT**

Interface type

The ***AMSIT** command specifies your interface type (RS-232, RS-485 or RS-422).

? Request

The interface parameters are displayed.

a Interface

- a = 1 -> RS-232
- a = 2 -> RS-422
- a = 3 -> RS-485

- #### **x**
- x = 0 -> The setting is only valid until the next voltage interrupt.
 - x = 1 -> The setting is stored.

AT*AMSIT=a, x

Example: **AT*AMSIT=1,1**

The interface is set to RS-232 and stored.

Request: **AT*AMSIT?**

Feedback:

***AMSIT:a**

9.7 Additional commands

*ACF

Read device list (favorites)

The *ACF command reads your device list.

a **Number of devices (favorites)**
x **Bluetooth address**
y **Device name**

Example: **AT*ACF?**

Feedback:

***ACF:a**
OK
***ACFD:x, y**

*ACACF

Add device

The *ACACF command adds a device to the device list (favorites). A maximum of ten devices is permitted.

x **Bluetooth address**
y **Device name (240 characters, maximum)**

AT*ACACF=x, y

Example: **AT*ACACF=0080371DA11E, Converter5**

The device with address 0080371DA11E and the name “Converter5” is added to the device list.



If the Bluetooth address already exists in the device list under another name, only the name is modified.

*ACDF

Delete device

The *ACDF command deletes a device from the device list (favorites).

x **Bluetooth address**

AT*ACDF=x

Example: **AT*ACDF=0080371DA11E**

The device with address 0080371DA11E is removed from the device list.

ACCB*Configuration via Bluetooth**

The ***ACCB** command enables device configuration via Bluetooth.

? Request

The interface parameters are displayed.

a Interface

- a = 0 -> Configuration is **not** possible via Bluetooth.
- a = 1 -> Configuration is also possible via Bluetooth.

x

- x = 0 -> The setting is only valid until the next voltage interrupt.
- x = 1 -> The setting is stored.

AT*ACCB=a, x

Example: **AT*ACCB=1,1**

Permission for configuration via Bluetooth is granted and stored.

AMPM*Energy-saving mode**

The ***AMPM** command enables energy-saving mode.

? Request

Energy-saving mode is displayed.

a Mode

- a = 1 -> No energy-saving mode
- a = 2 -> Energy-saving mode: "Sleep" activated
- a = 3 -> Energy-saving mode: "Sleep" and "Stop" activated

x

- x = 0 -> The setting is only valid until the next voltage interrupt.
- x = 1 -> The setting is stored.

AT*AMAP=a, x

Example: **AT*AMSIT=1,1**

Energy-saving mode is disabled and this setting is stored.

AMMP*Transmission power**

The ***AMMP** command specifies the maximum transmission power.

? Request

The maximum transmission power is displayed.

a Transmission power

Value range: 98 ... 158 (128 -> 0 dBm)

x

- x = 0 -> The setting is only valid until the next voltage interrupt.
- x = 1 -> The setting is stored.

AT*AMMP=a, x

Example: **AT*AMSIT=138,1**

The maximum transmission power is limited to 10 dBm and stored.

***AMET**

Escape string waiting time

The ***AMET** command specifies the waiting time before and after the Escape string. To ensure that the Escape string (default: **+++**) entry for switching to command mode is valid, a data pause must be observed before and after entry.

? Request

The waiting time before and after the Escape string is displayed.

a Waiting time before the string

Value range: 50 ... 2000 ms

b Waiting time after the string

Value range: 50 ... 2000 ms

- x**
- x = 0 -> The setting is only valid until the next voltage interrupt.
 - x = 1 -> The setting is stored.

AT*AMET=a, b, x

Example: **AT*AMET=1000,1000,1**

The waiting time before and after the Escape string is set to one second and stored.

***AMSF**

Specify the factory settings

The ***AMSF** command specifies the current configuration of the Bluetooth converter as the factory settings. The **AT&F** command can be used to restore these settings at any time.

Example: **AT*AMSF**

Feedback: **OK**

A Technical appendix

A 1 Typical combinations of antennas and adapter cables

In this section, you will find typical combinations of Bluetooth converters, antennas and adapter cables for the installation with or without a control cabinet.



Install the antenna outside the control cabinet or building.

Please also observe the installation instructions for the antenna as well as Section “For your safety” on page 13.

Observe the maximum permissible emitted transmission power of 20 dBm. The transmission power can be calculated from:

device transmission power + antenna gain - cable attenuation

Reduce the device transmission power, if necessary.

Omnidirectional antenna, 2 dBi

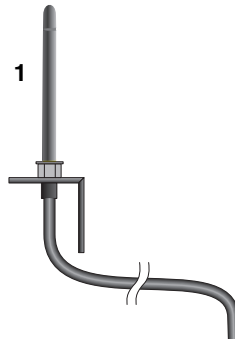

Figure A-1 Omnidirectional antenna, 2 dBi

Item	Product	Description	Connection	Order No.
1	RAD-ISM-2400-ANT-OMNI-2-1	Omnidirectional antenna, 2.4 GHz, 2 dBi gain, 1.5 m cable length, linear vertical polarization, h/v 360°/75° apex angle, IP65 protection	MCX (male)	2867461

Omnidirectional antenna with protection against vandalism, 2.5 dBi

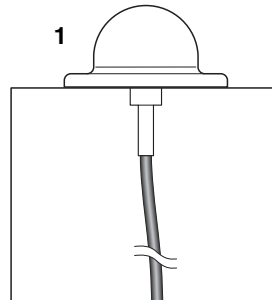

Figure A-2 Omnidirectional antenna with protection against vandalism, 2.5 dBi

Item	Product	Description	Connection	Order No.
1	RAD-ISM-2400-ANT-VAN-3-1-MCX	Omnidirectional antenna with protection against vandalism, 2.4 GHz, 3 dBi gain, IP55 protection, 1.5 m cable length, h/v 360°/85° apex angle. Appropriate mounting material is available for wall mounting.	MCX (male)	2885702

Omnidirectional antenna, 6 dBi, without surge protection

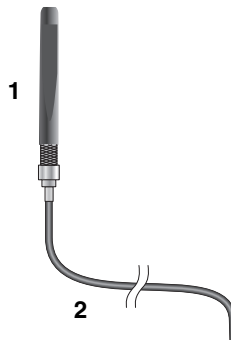

Figure A-3 Omnidirectional antenna, 6 dBi, without surge protection

Item	Product	Description	Connection	Order No.
1	RAD-ISM-2400-ANT-OMNI-6-0	Omnidirectional antenna, 2.4 GHz, 6 dBi gain, linear vertical polarization, h/v 360°/30° apex angle, IP55 protection	N (female)	2885919
	Alternative: RAD-2400-ANT-OMNI-6-0-SW	Omnidirectional antenna, 2.4 GHz, 6 dBi gain, linear vertical polarization, h/v 360°/20° apex angle, IP65 protection, salt water resistant	N (female)	2903219
2	RAD-PIG-EF316-MCX-N	Antenna cable, 0.5 m length, insertion loss: 0.95 dB at 2.4 GHz	MCX (male) → N (male)	2867681

Omnidirectional antenna, 6 dBi, with outdoor surge protection

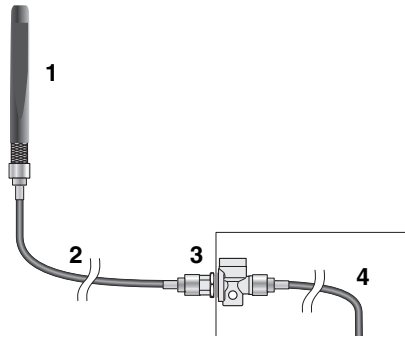

Figure A-4 Omnidirectional antenna, 6 dBi, with outdoor surge protection

Items 2 and 3 are optional.

Item	Product	Description	Connection	Order No.
1	RAD-ISM-2400-ANT-OMNI-6-0	Omnidirectional antenna, 2.4 GHz, 6 dBi gain, linear vertical polarization, h/v 360°/30° apex angle, IP55 protection	N (female)	2885919
	Alternative: RAD-2400-ANT-OMNI-6-0-SW	Omnidirectional antenna, 2.4 GHz, 6 dBi gain, linear vertical polarization, h/v 360°/20° apex angle, IP65 protection, salt water resistant	N (female)	2903219
2 (opt.)	RAD-CAB-EF393- 3M	Antenna cable, 3 m length, insertion loss: approx. 0.45 dB/m at 2.4 GHz	N (male) → N (male)	2867649
	Alternative: RAD-CAB-EF393- 5M	Antenna cable, 5 m length, insertion loss: approx. 0.45 dB/m at 2.4 GHz	N (male) → N (male)	2867652
	RAD-CAB-EF393-10M	Antenna cable, 10 m length, insertion loss: approx. 0.45 dB/m at 2.4 GHz	N (male) → N (male)	2867665
	RAD-CAB-EF393-15M	Antenna extension cable, 15 m length, insertion loss: approx. 0.45 dB/m at 2.4 GHz	N (male) → N (male)	2885634
3 (opt.)	CN-LAMBDA/4-5.9-BB	Attachment plug with Lambda/4 technology as surge protection for coaxial signal interfaces	N (female) → N (female)	2838490
4	RAD-PIG-EF316-MCX-N	Antenna cable, 0.5 m length, insertion loss: 0.95 dB at 2.4 GHz	MCX (male) → N (male)	2867681

Panel antenna, 9 dBi, with outdoor surge protection

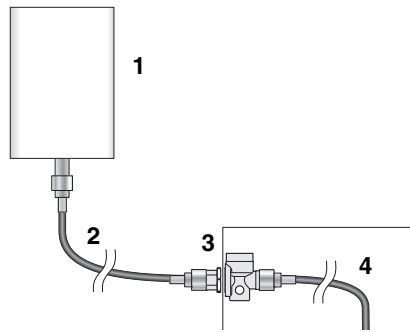

Figure A-5 Panel antenna, 9 dBi, with outdoor surge protection

Items 2 and 3 are optional.

Item	Product	Description	Connection	Order No.
1	ANT-DIR-2459-01	Panel antenna, 2.4/5 GHz, 9 dBi gain, linear vertical polarization, h/v 75°/70° apex angle at 2.4 GHz, IP67 protection	N (female)	2701186
2 (opt.)	RAD-CAB-EF393- 3M	Antenna cable, 3 m length, insertion loss: approx. 0.45 dB/m at 2.4 GHz	N (male) → N (male)	2867649
	Alternative: RAD-CAB-EF393- 5M	Antenna cable, 5 m length, insertion loss: approx. 0.45 dB/m at 2.4 GHz	N (male) → N (male)	2867652
	RAD-CAB-EF393-10M	Antenna cable, 10 m length, insertion loss: approx. 0.45 dB/m at 2.4 GHz	N (male) → N (male)	2867665
	RAD-CAB-EF393-15M	Antenna cable, 15 m length, insertion loss: approx. 0.45 dB/m at 2.4 GHz	N (male) → N (male)	2885634
3 (opt.)	CN-LAMBDA/4-5.9-BB	Attachment plug with LAMBDA/4 technology as surge protection for coaxial signal interfaces	N (female) → N (female)	2838490
4	RAD-PIG-EF316-MCX-N	Antenna cable, 0.5 m length, insertion loss: 0.95 dB at 2.4 GHz	MCX (male) → N (male)	2867681

A 2 Configuring a PROFIBUS connection

In order to configure a point-to-point connection or point-to-multipoint network for PROFIBUS transmission, proceed as follows:

- Download the latest PSI-CONF software from the Internet at phoenixcontact.net/products.
- Install the software on your computer.
- Prior to configuration, set the CONF/RUN slide switch to the CONF position (see “Setting configuration mode” on page 21).



For configuration, the following is required:

- Serial programming cable PSM-KA9SUB9/BB/2METER, Order No. 2799474
- USB cable PSI-CA-USB A/MINI B/1METER, Order No. 2313575

A 2.1 Configuring a point-to-point connection

- Start the PSI-CONF software.



Figure A-6 PSI-CONF software

- In the “Wireless” folder, select the device.

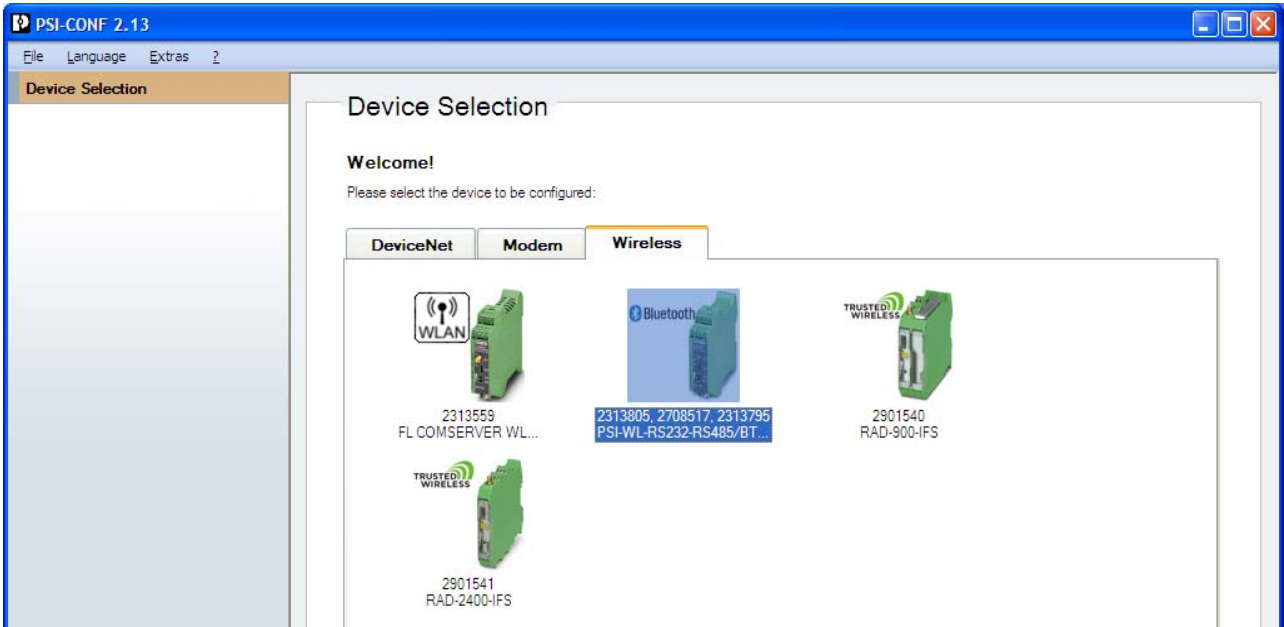

Figure A-7 PSI-CONF software: Device selection

- Select “Configuration Mode, Local configuration”.

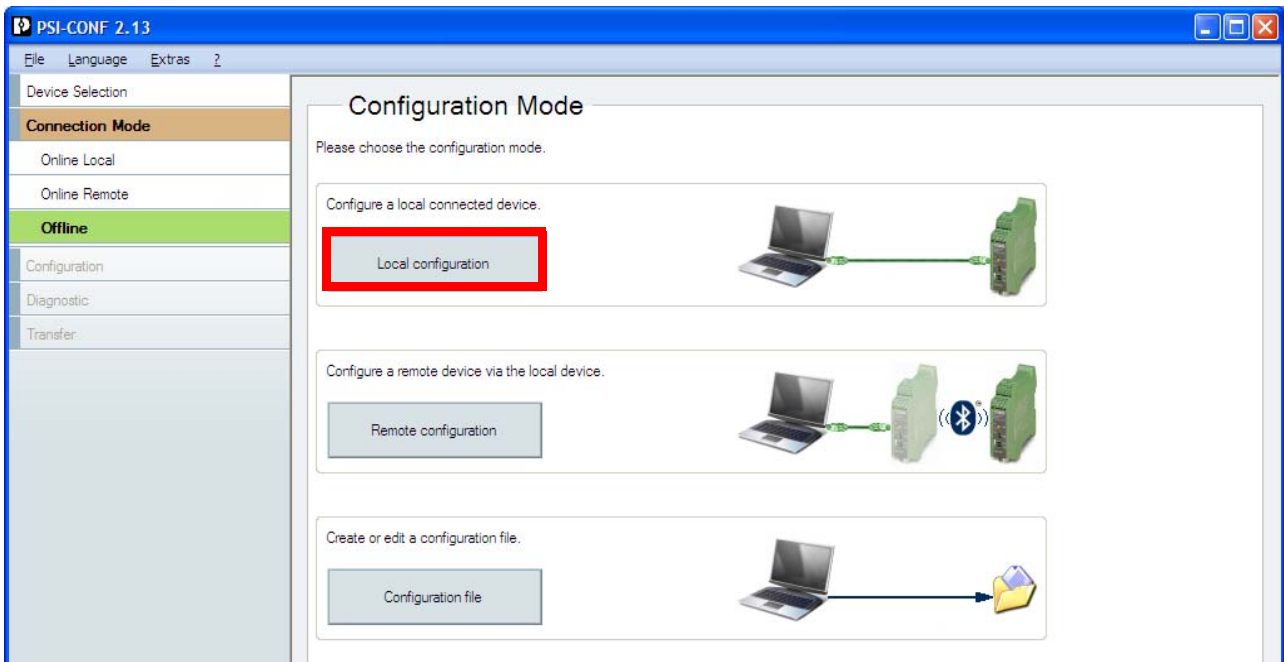

Figure A-8 PSI-CONF software: Local configuration

- Follow the installation instructions and confirm with “Next”.
- Select the “With PSI-WL.../BT/...” option in the Point to Point Wizard.

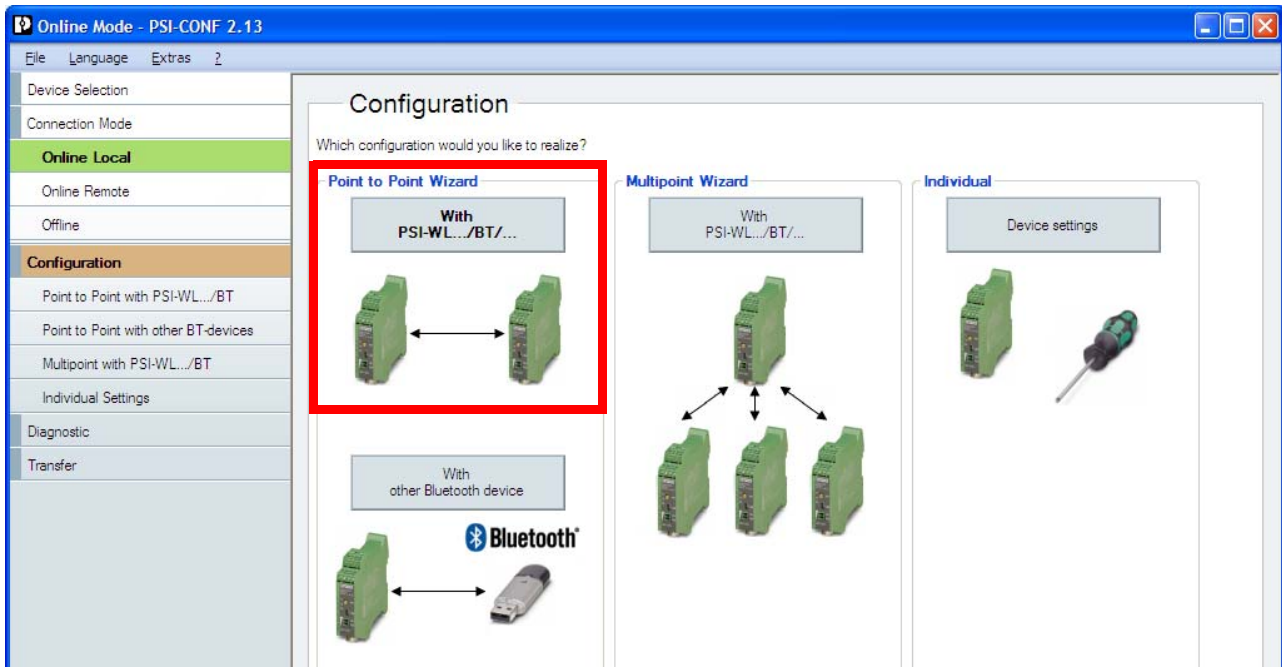

Figure A-9 PSI-CONF software: Configuration

- Enter a name and a password.
- Select the “PROFIBUS” connection profile and set a baud rate of “187500”.
- Confirm with “Next”.

The set parameters are now transmitted to the device.

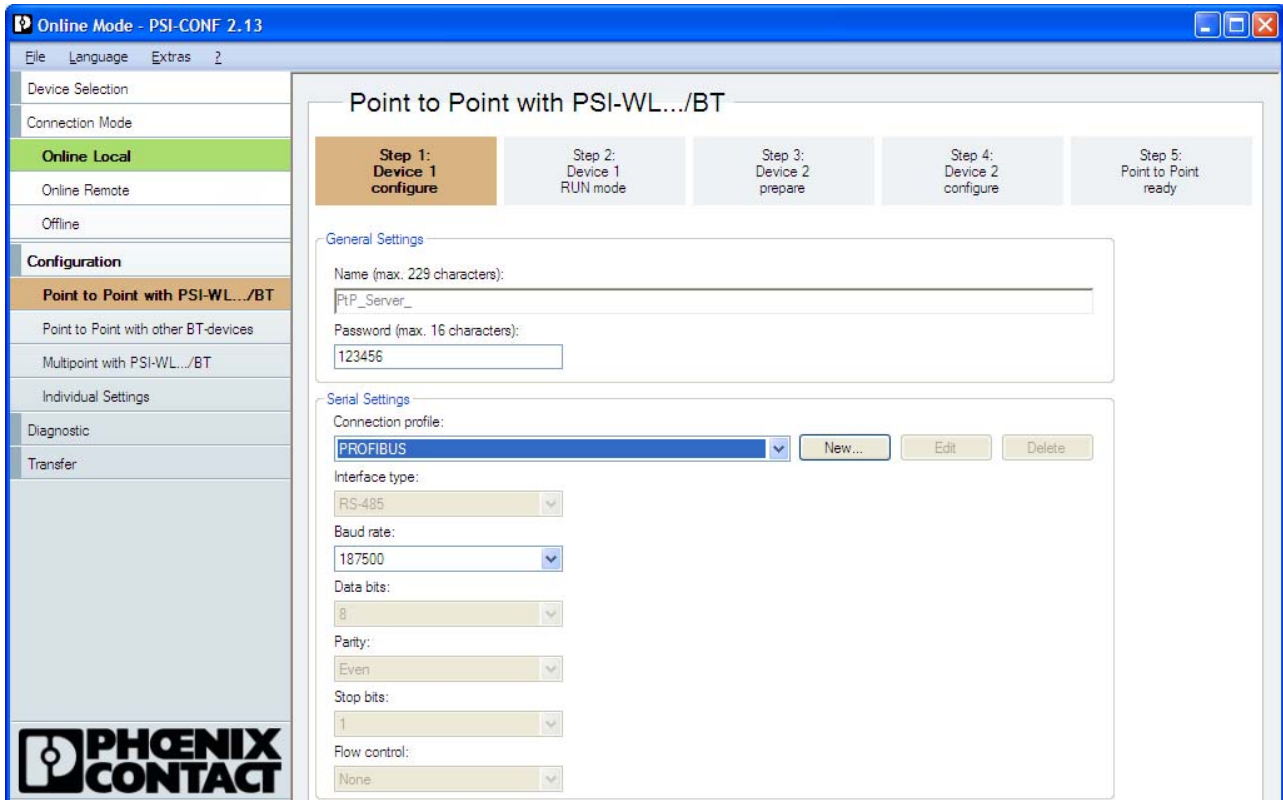

Figure A-10 PSI-CONF software: Point-to-point with PSI-WL.../BT, step 1

- Follow the software wizard with “Step 2” and “Step 3”.
- In “Step 4”, enter a name and confirm with “Next”.

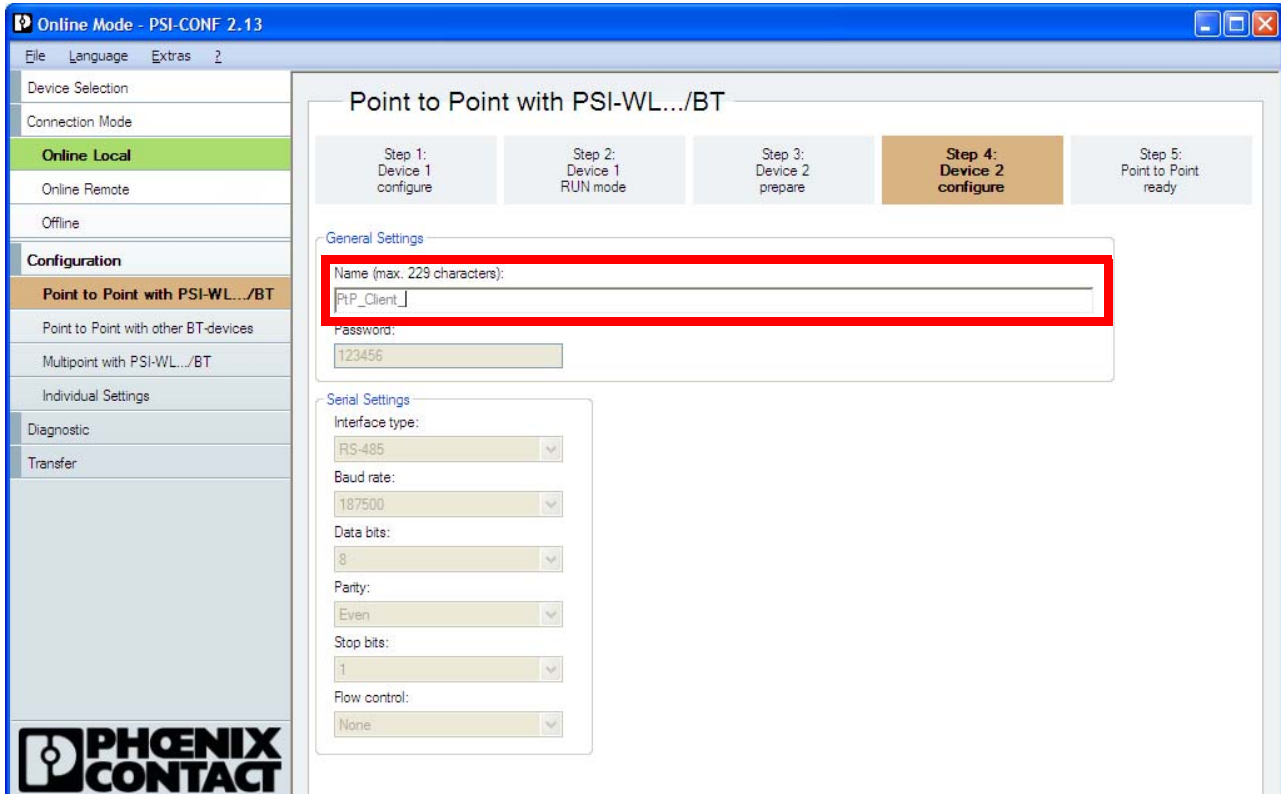

Figure A-11 PSI-CONF software: Point-to-point with PSI-WL.../BT, step 4

- Configuration is now complete. Confirm with “Finish”.
- Exit the software via “File, Exit” and follow the instructions.

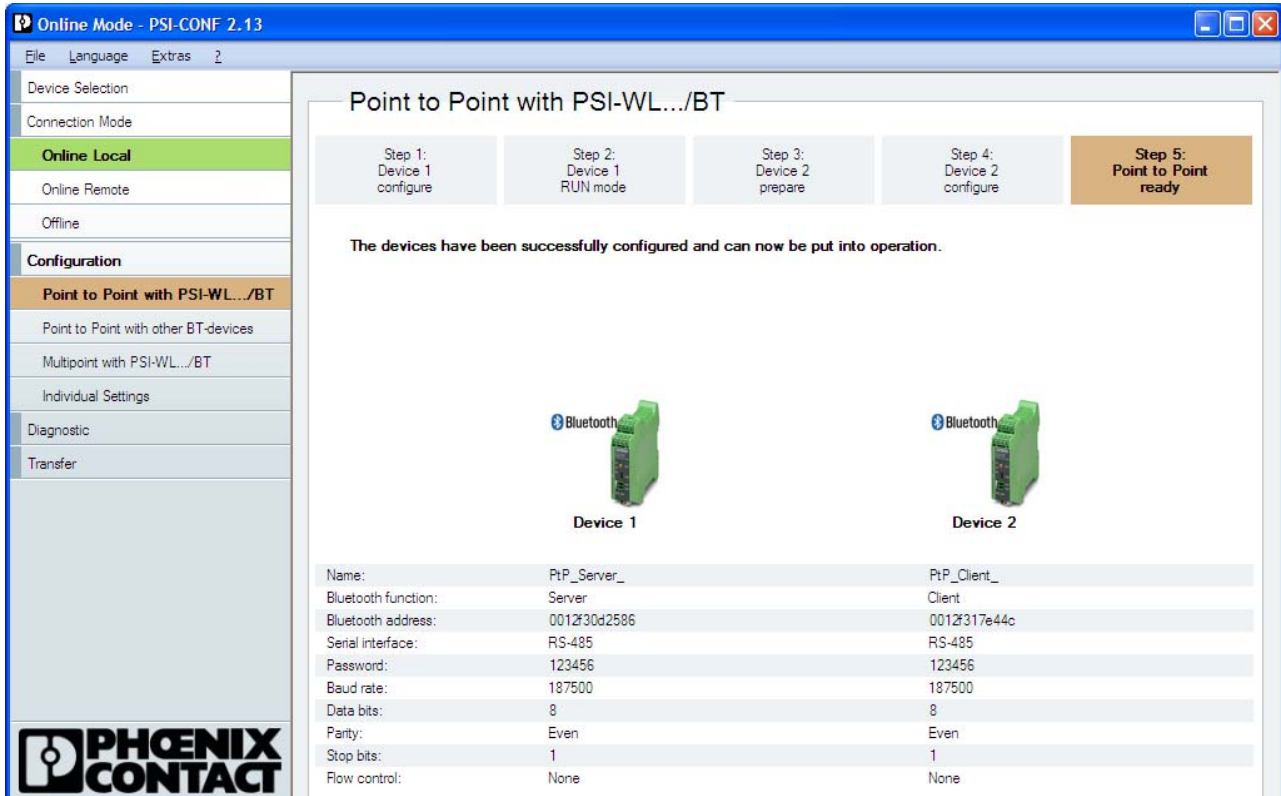

Figure A-12 PSI-CONF software: Point-to-point with PSI-WL.../BT, step 5

A 2.2 Configuring a point-to-multipoint network (star)

- Start the PSI-CONF software.



Figure A-13 PSI-CONF software

- In the "Wireless" folder, select the device.

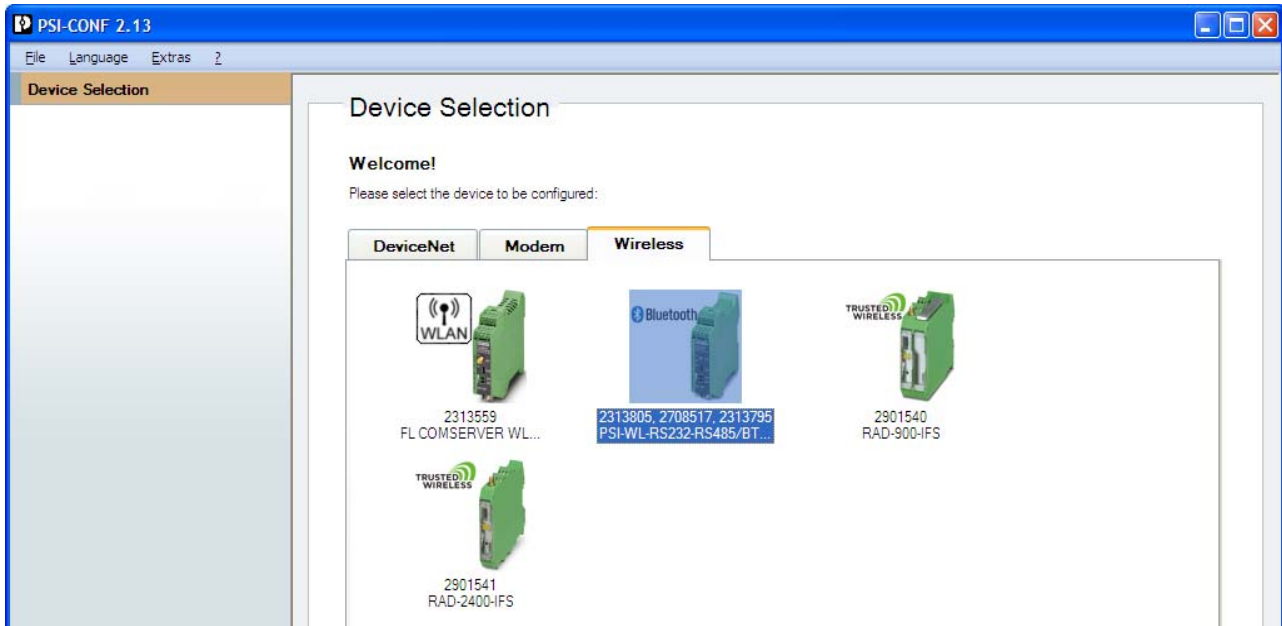

Figure A-14 PSI-CONF software: Device selection

- Select “Configuration Mode, Local configuration”.

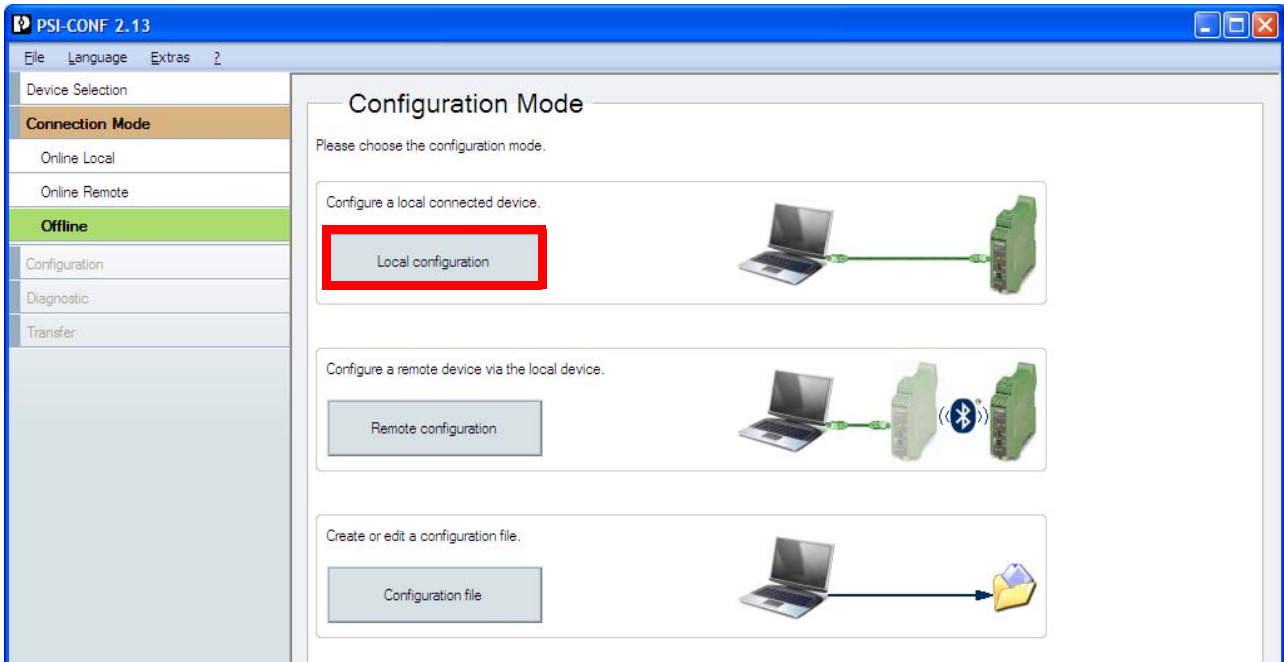

Figure A-15 PSI-CONF software: Local configuration

- Follow the installation instructions and confirm with “Next”.
- Select the “With PSI-WL.../BT/...” option in the Multipoint Wizard.

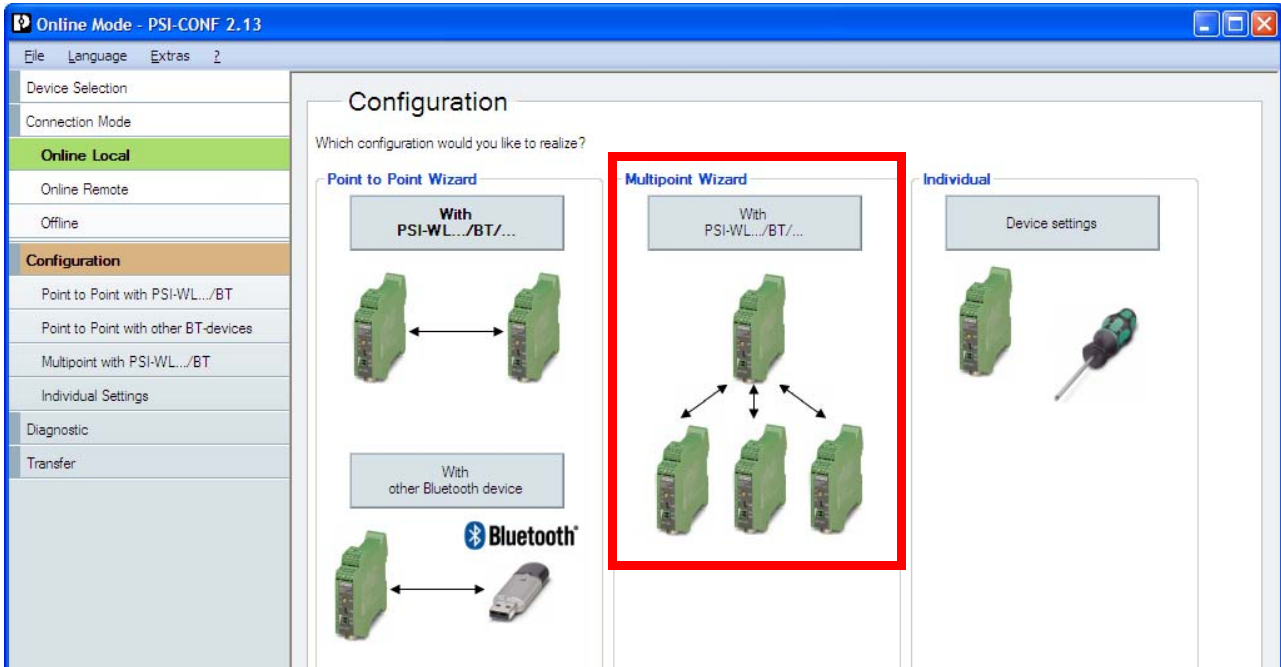

Figure A-16 PSI-CONF software: Configuration



Selecting the “Multipoint” network type increases the delay time.
The delay time depends on the number of slaves in the network.

- Enter the number of slaves and select the master role (see page 18).

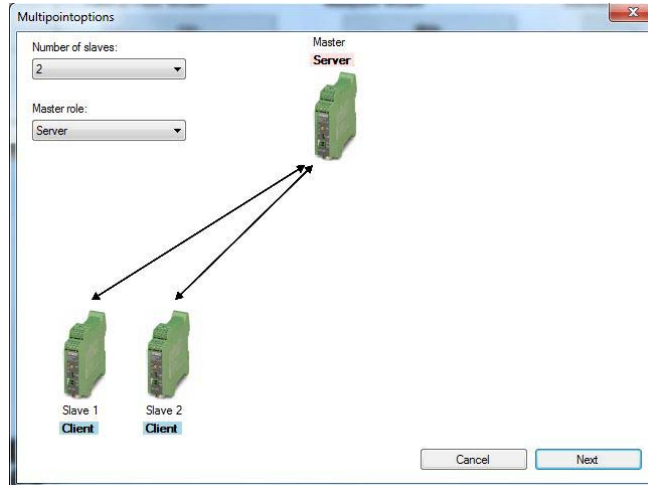

Figure A-17 Multipoint options

- Configure the following in step 1:
 - Name
 - Password
 - Connection profile: PROFIBUS
 - Baud rate: 93750



The baud rate depends on the number of slaves in the network. The more devices in the network the lower the baud rate must be set (see “Theoretical delay times - PROFIBUS via Bluetooth converter” on page 95).

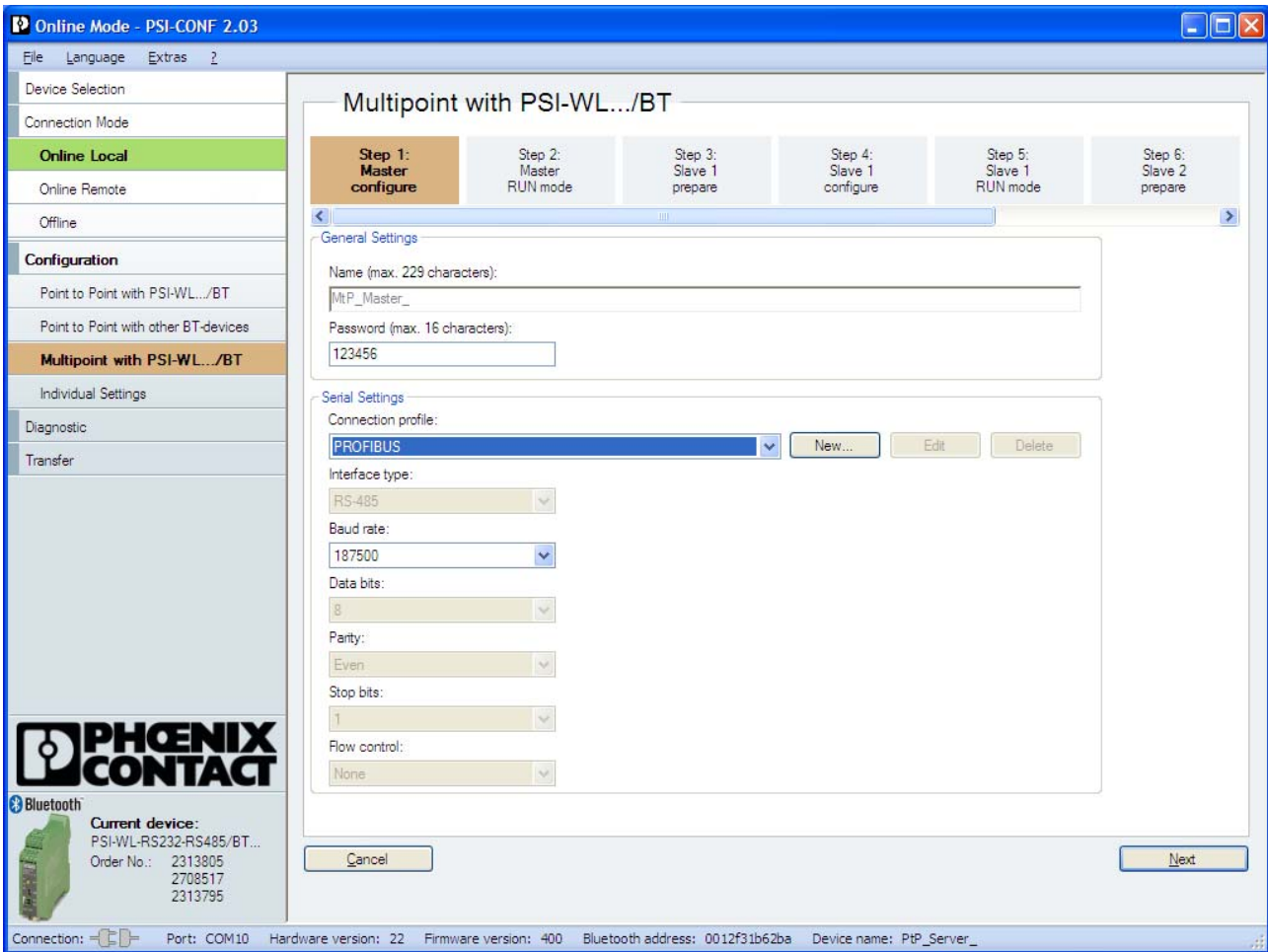

Figure A-18 PSI-CONF software: Multipoint with PSI-WL.../BT, step 1

The set parameters are now transmitted to the device.

- Follow the software wizard from “Step 2” to “Step 7”.

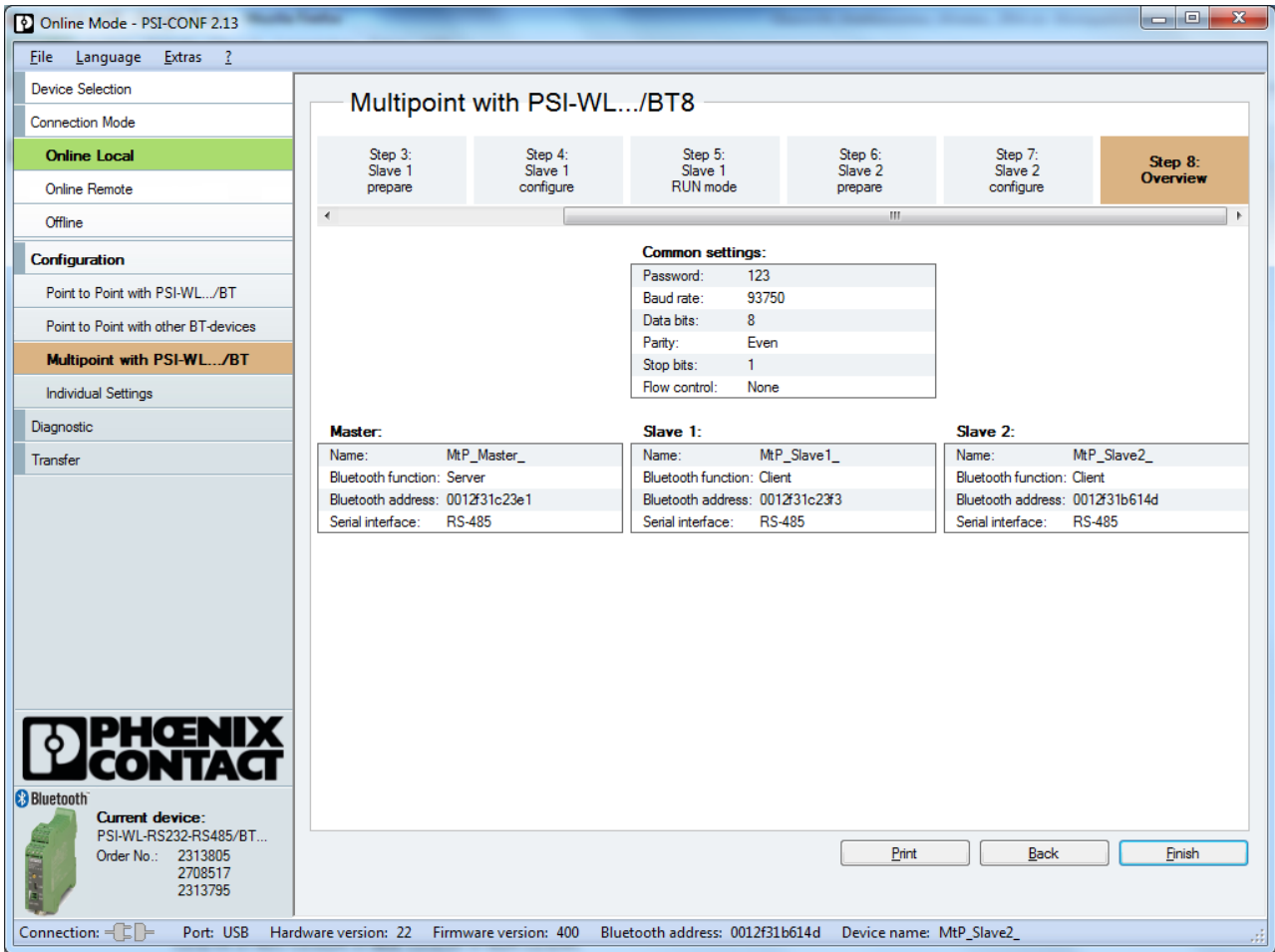

Figure A-19 PSI-CONF software: Multipoint with PSI-WL.../BT, step 8

- Configuration is now complete. Confirm with “Finish”.
- Exit the software via “File, Exit” and follow the instructions.

A 2.3 Connecting the PROFIBUS cable

- Connect the PROFIBUS cable to both Bluetooth converters:
 - Negative data wire (green) to terminal D(A)
 - Positive data wire (red) to terminal D(B)
- Activate bus termination if the Bluetooth converter is located at the start or the end of the electrical PROFIBUS segment. Set the slide switch to the “ON” position (see “Activating the termination network” on page 20).

A 2.4 Configuring the PROFIBUS master

- Adjust the timing in the PROFIBUS master to the signal runtime over the wireless path.

This setting is shown here using the SIMATIC Manager, Version 5.x, as an example.

The Bluetooth converters do not modify the PROFIBUS telegram (transparent transmission, “Tunneling”). They only modify the PROFIBUS cycle time. In the case of an optimum wireless connection, the Bluetooth converters will cause a delay time of approximately 50 ms, unidirectionally approximately 25 ms.

If the Bluetooth converter is connected in series with other components that also cause a delay time, the delay times must be added together. Remember to take into account long cables, repeaters, fiber optics, other wireless components, etc.

The additional delay time may be increased in the event of a poor wireless connection, or the connection may be terminated completely. In the case of a poor connection, the Bluetooth converter would not discard PROFIBUS telegrams but try to repeatedly transmit them.

- For the wireless connection, consider the following PROFIBUS situations:
 - **In the PROFIBUS master - minimum delay time of 50 ms**
Tslot_Init parameter (maximum wait time for receipt)
 - **In the PROFIBUS master - short interruption of the wireless connection**
Retrylimit parameter (maximum number of connection retries)
 - **In the PROFIBUS slave - permanent interruption of the wireless connection**
Response monitoring time (watchdog) parameter
- You have two options for setting the Tslot_Init parameter (maximum wait time for receipt):
 - **Automatically** - Enter the number of repeaters and the cable length under “Options, Cables”.
 - **Manually** - Directly enter the bus parameters under “User-defined, Bus Parameters”. In this case, deactivate the automatic calculation, otherwise the sum of automatic and manual entry will be used.

We recommend that you use manual entry:

- Entry: Tslot_Init > 13000 t_bit
- Entry: Retry limit > 3
- Recalculate
- Entry: Response monitoring time, depending on the application

Under certain circumstances, it may be required that the Tslot_Init value is greater than 13000 t_bit. This may occur, for example, if there is a poor wireless connection or if the components are connected in series. The value of 50 ms will increase by factor x.

The Tslot_Init parameter is expressed in t_bit. The maximum value for a Siemens S7 PLC is 16383 t_bit (S5: 9999 t_bit). The maximum wait time for receipt is therefore 187.5 kbps = 87 ms. In this case, value 13000 t_bit corresponds to a value of 69 ms (minimum delay time of the Bluetooth converter + reserve).

- Start the SIMATIC Manager and open your user project.
Select “Options, Configure Network” from the pull-down menu.

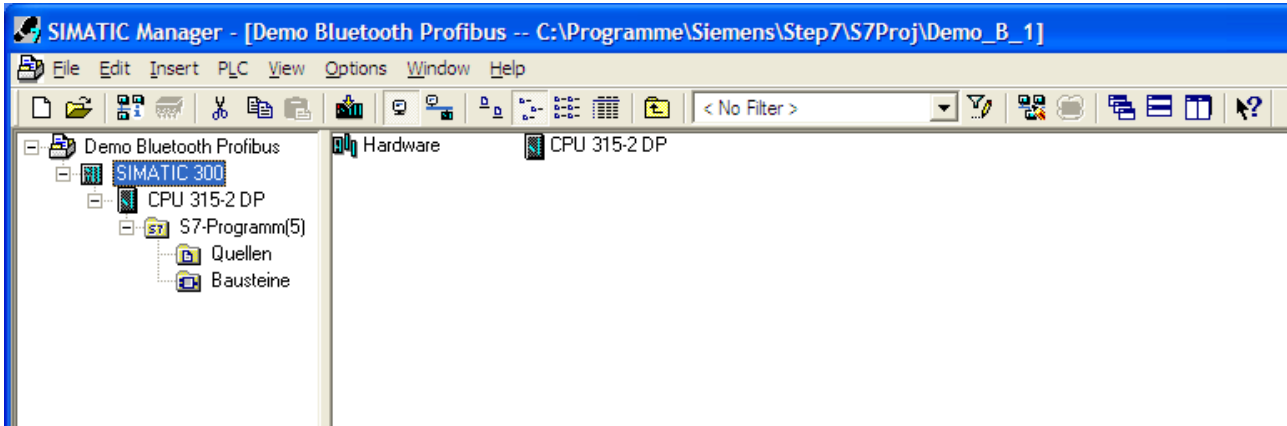

Figure A-20 SIMATIC Manager

- In the “NetPro” window, right-click the PROFIBUS line. In the context menu, open “Object Properties”.

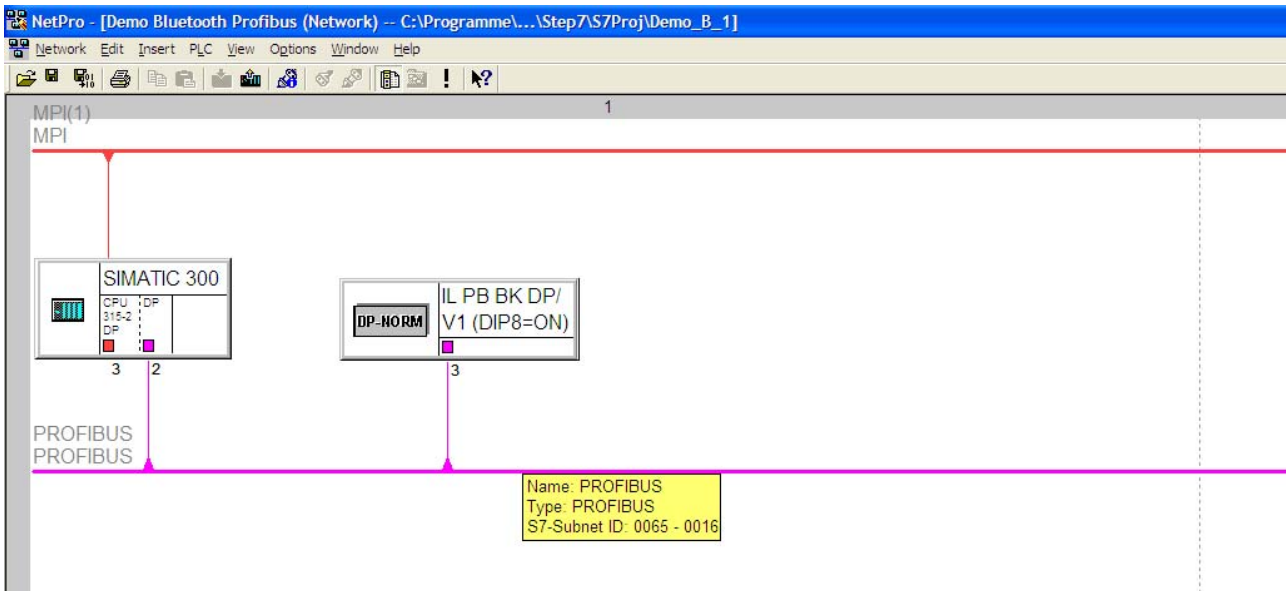

Figure A-21 “NetPro” window

- In the “Network Settings” tab, select a transmission speed of 187.5 kbps.
- Click on “Options”.

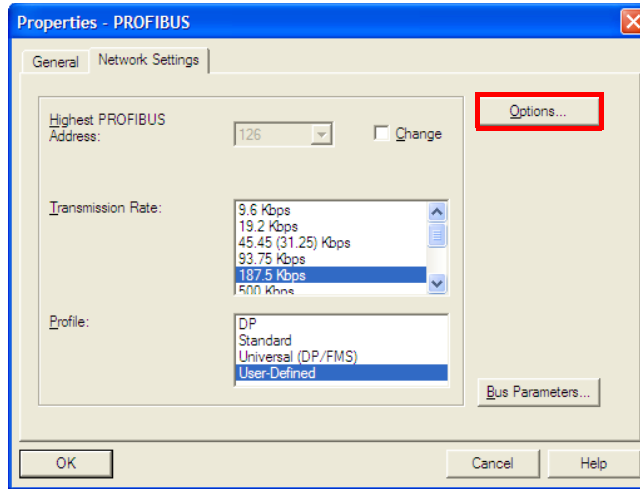

Figure A-22 “Network Settings” tab, transmission speed

- In the “Cables” tab, deactivate the “Take into account the following cable configuration” checkbox. Confirm with “OK”.

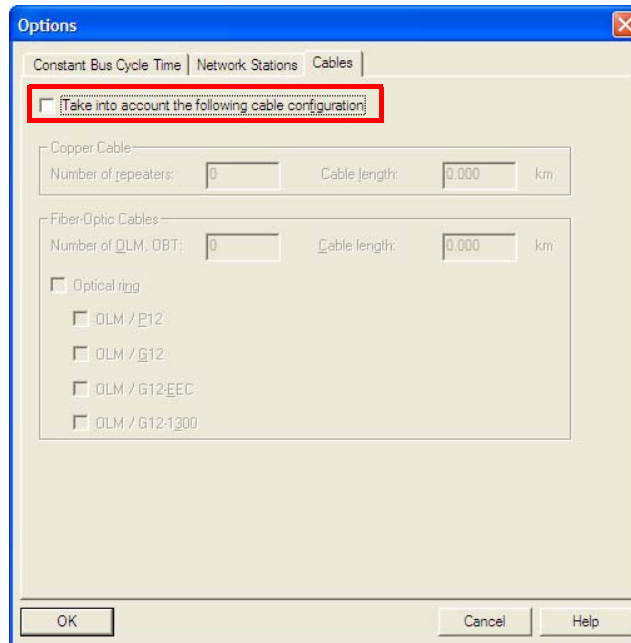

Figure A-23 “Cables” tab

- In the “Network Settings” tab, select the “User-Defined” profile and the “Bus Parameters” option.

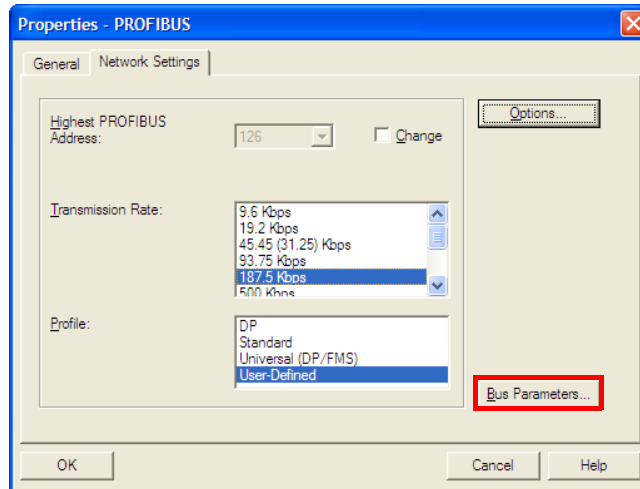

Figure A-24 “Network Settings” tab, profile

- In the “Bus Parameters” tab, the most recently valid bus parameters are shown. Enter the following values:



The value for the Tslot time and the telegram runtime of PROFIBUS depend on your application. Start with 13000 t_bit in order to achieve the smallest possible telegram runtime. Increase the value if bus errors occur.

Tslot_Init	13000 t_bit ... 16383 t_bit
Max. Tsdr	60
Min. Tsdr	11
Tset	1
Tqui	0
Gap Factor	10
Retry limit	5

- Confirm the entry with “Recalculate”.

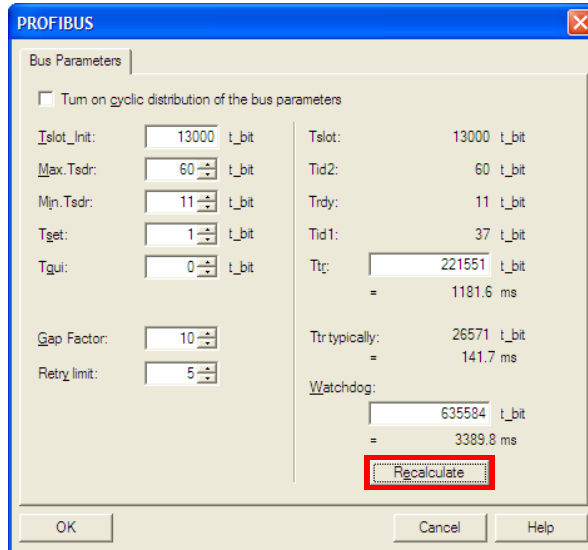

Figure A-25 “Bus Parameters” tab

- Recalculating the bus parameters also modifies the response monitoring (watchdog) value. Enter 187500 t_bit here to achieve a response monitoring (watchdog) time of 1 second for the PROFIBUS slave. Confirm with “OK”.

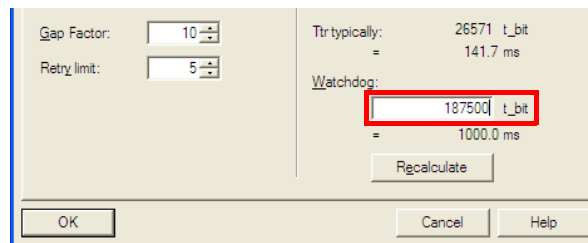

Figure A-26 “Bus Parameters” tab, watchdog

- Go back to the “NetPro” view. Save and compile the changes.
- Transfer all settings to the PROFIBUS master.
- Test whether the PROFIBUS devices are available via the wireless path.

Evaluating PROFIBUS errors

If the wireless connection is interrupted for a longer period, a PROFIBUS error is triggered. This may stop the CPU or the PLC. If you set up the **OB86** in STEP7 and program the handling of PROFIBUS errors in it, you can bypass the stop state. In addition, the errors can be evaluated in this way.

- Green fields = data rate possible
- Red fields = data rate not possible

Table A-1 Theoretical delay times - PROFIBUS via Bluetooth converter

Bluetooth		PROFIBUS			
	Bidirectional delay [s]	Data rate [bps]	Bit time [s] (=1/data rate)	Min. TBit in relation to the Bluetooth delay [TBit] (delay/bit time)	Max. TBit ¹ x bit time [s]
PtP	0.05	9600	0.000104167	480	1.706562500
		19200	0.000052083	960	0.853281250
		93750	0.000010667	4688	0.174752000
		187500	0.000005333	9375	0.087376000
		500000	0.000002000	25000	0.032766000
		1500000	0.000000667	75000	0.010922000
MIP 2 slaves	0.1	9600	0.000104167	960	1.706562500
		19200	0.000052083	1920	0.853281250
		93750	0.000010667	9375	0.174752000
		187500	0.000005333	18750	0.087376000
		500000	0.000002000	50000	0.032766000
MIP 3 slaves	0.15	9600	0.000104167	1440	1.706562500
		19200	0.000052083	2880	0.853281250
		93750	0.000010667	14063	0.174752000
		187500	0.000005333	28125	0.087376000
		500000	0.000002000	75000	0.032766000
MIP 4 slaves	0.2	9600	0.000104167	1920	1.706562500
		19200	0.000052083	3840	0.853281250
		93750	0.000010667	18750	0.174752000
		187500	0.000005333	37500	0.087376000
		500000	0.000002000	100000	0.032766000
MIP 5 slaves	0.25	9600	0.000104167	2400	1.706562500
		19200	0.000052083	4800	0.853281250
		93750	0.000010667	23438	0.174752000
		187500	0.000005333	46875	0.087376000
		500000	0.000002000	125000	0.032766000
MIP 6 slaves	0.3	9600	0.000104167	2880	1.706562500
		19200	0.000052083	5760	0.853281250
		93750	0.000010667	28125	0.174752000
		187500	0.000005333	56250	0.087376000
		500000	0.000002000	150000	0.032766000
MIP 7 slaves	0.35	9600	0.000104167	3360	1.706562500
		19200	0.000052083	6720	0.853281250
		93750	0.000010667	32813	0.174752000
		187500	0.000005333	65625	0.087376000
		500000	0.000002000	175000	0.032766000

¹ Max TBit according to Simatic Manager = 16383

B Appendixes

B 1 List of figures

Figure 3-1:	Dimensions [mm]	16
Figure 3-2:	Block diagram	16
Figure 3-3:	Design	17
Figure 3-4:	Point-to-point connection, point-to-multipoint network (star)	18
Figure 4-1:	Opening the housing	19
Figure 4-2:	Slide switch for termination network	20
Figure 4-3:	CONF/RUN slide switch	21
Figure 4-4:	Reset button	22
Figure 5-1:	Mounting on a DIN rail	23
Figure 5-2:	Combined assembly	24
Figure 5-3:	Removal	25
Figure 5-4:	Power supply	26
Figure 5-5:	RS-232 interface	27
Figure 5-6:	RS-422 interface	28
Figure 5-7:	RS-485 interface	28
Figure 5-8:	Diagnostics indicators during normal operation	29
Figure 7-1:	Antenna polarization	37
Figure 7-2:	Dispersion on a rough surface	41
Figure 7-3:	Diffraction on an edge	41
Figure 7-4:	Reflection on a metal surface	42
Figure 7-5:	Reduction of radio waves when penetrating a wall	42
Figure 7-6:	Angle of the transmitter and receiver	43
Figure 7-7:	Radio dead spot	43
Figure 7-8:	Wireless path with strong wind	44
Figure 7-9:	Fresnel zone	45
Figure 7-10:	Free space path loss	47
Figure 7-11:	Bush with an attenuation of approximately 15 dB	49
Figure 7-12:	Forest with an attenuation of about 40 dB	49
Figure 8-1:	Loopback test on an RS-232 interface	51
Figure 8-2:	Settings in HyperTerminal	52
Figure A-1:	Omnidirectional antenna, 2 dBi	75
Figure A-2:	Omnidirectional antenna with protection against vandalism, 2.5 dBi ..	76
Figure A-3:	Omnidirectional antenna, 6 dBi, without surge protection	76

Figure A-4:	Omnidirectional antenna, 6 dBi, with outdoor surge protection	77
Figure A-5:	Panel antenna, 9 dBi, with outdoor surge protection	78
Figure A-6:	PSI-CONF software	79
Figure A-7:	PSI-CONF software: Device selection	80
Figure A-8:	PSI-CONF software: Local configuration	80
Figure A-9:	PSI-CONF software: Configuration	81
Figure A-10:	PSI-CONF software: Point-to-point with PSI-WL.../BT, step 1	82
Figure A-11:	PSI-CONF software: Point-to-point with PSI-WL.../BT, step 4	83
Figure A-12:	PSI-CONF software: Point-to-point with PSI-WL.../BT, step 5	84
Figure A-13:	PSI-CONF software	85
Figure A-14:	PSI-CONF software: Device selection	85
Figure A-15:	PSI-CONF software: Local configuration	86
Figure A-16:	PSI-CONF software: Configuration	87
Figure A-17:	Multipoint options	87
Figure A-18:	PSI-CONF software: Multipoint with PSI-WL.../BT, step 1	88
Figure A-19:	PSI-CONF software: Multipoint with PSI-WL.../BT, step 8	89
Figure A-20:	SIMATIC Manager	91
Figure A-21:	“NetPro” window	91
Figure A-22:	“Network Settings” tab, transmission speed	92
Figure A-23:	“Cables” tab	92
Figure A-24:	“Network Settings” tab, profile	93
Figure A-25:	“Bus Parameters” tab	94
Figure A-26:	“Bus Parameters” tab, watchdog	94

B 2 List of tables

Table 4-1:	Slide switch for termination network	20
Table 4-2:	CONF/RUN slide switch	21
Table 5-1:	Bar graph.....	29
Table 6-1:	Without termination device addressing (RS-232, RS-422, etc.).....	33
Table 6-2:	With termination device addressing (RS-485, 2-wire).....	34
Table 6-3:	Multi-drop connection	34
Table 7-1:	Antenna selection	36
Table 7-2:	Level.....	38
Table 7-3:	Attenuation of accessories.....	38
Table 7-4:	Antenna gain	39
Table 7-5:	Free space path loss	40
Table 7-6:	Attenuation with regard to different materials.....	42
Table 7-7:	Radius of the Fresnel zone depending on the distance	45
Table 7-8:	Ranges for different antennas.....	46
Table A-1:	Theoretical delay times - PROFIBUS via Bluetooth converter	95

B 3 Index

A

Accessories	7, 75
Adapter cable.....	75
Antenna	
Alignment	37
Installation	37
Selection	36
Antenna cable	36
Antenna connection	29
AT command.....	53
Attenuation.....	38

B

Bar graph	29
Block diagram	16
Bus termination	
See Termination resistors	

C

Checking the location.....	35
Circuit diagram	
See Block diagram	
Client.....	18
Coaxial cable	36
Command mode	53
CONF/RUN slide switch.....	21
Configuration.....	31
Configuration mode.....	21
Connection mode.....	57
Connection station	24, 26
Connections.....	17, 27
Crosstalk.....	18

D

Data Communication Equipment (DCE).....	27
Data mode	65
Default setting	22
Delivery state	
See Resetting to the default settings	
Detection mode.....	56
Device search	59
Diffraction.....	41
Dimensions	16

DIN rail connector	24, 25, 26
Dispersion.....	41

E

EEPROM	53
EIRP (Equivalent Isotropically Radiated Power)	
See Equivalent isotropically radiated power	
Energy-saving mode	73
Equivalent isotropically radiated power	47
Escape string	53
Example calculation	
See System calculation	

F

Free space path loss.....	40, 47
Fresnel zone	44
Function elements.....	17

G

GPS device	35
------------------	----

I

Information command	69
Interface command	70

L

Level	38
Loopback test	51

M

Master.....	18
Mounting	
Connection station	24
Single device.....	23
Multi-drop connection	34
Multipath propagation	41

O

Omnidirectional antenna	36
Opening the housing.....	19
Operating mode	
See Configuration mode	

Ordering data 7

P

Pairing 60
 Pairing mode 57
 Penetration 42
 Pigtail 38
 Pin assignment 27
 Planning of wireless systems 35
 Point-to-multipoint network 18, 85
 Point-to-point connection 18, 33, 79
 Power supply
 See Supply voltage
 Practical test 35
 Product description 15
 PROFIBUS 79
 PROFIBUS cable 90
 PROFIBUS master 90
 PROFIBUS network 33
 Programming connection 33

R

Radiated power
 See Equivalent isotropically radiated power
 Radio dead spot 43
 Radio waves 41
 Rain 44
 Range 46
 Redundant power supply 26
 Reflection 42
 Removal 25
 Removing errors 51
 Reset button 22
 Resetting to the default settings 22, 55
 RS-232 interface 27
 RS-422 interface 28
 RS-485 interface 28

S

Safety notes 13
 Security mode 58
 Serial data mode 33
 Serial interface 27
 Server 18
 Service profile 63

Shielding 27
 Signal strength 29, 62
 SIMATIC Manager 91
 Single device 23
 Slave 18
 Slide switch 20, 21
 Star
 See Point-to-multipoint network
 Supply voltage 26
 System calculation 47
 System configuration 18
 System power supply 26

T

TBUS
 See DIN rail connector
 Technical data 7
 Termination network
 See Termination resistors
 Termination resistors 20
 Transmission power
 See Equivalent isotropically radiated power
 Troubleshooting 51
 Typing error 54

U

UL note 11

W

Weather influences 44
 Wind 44
 Wireless performance diagnostics 29