

**Data sheet | Item number: 2000-1307**

3-conductor ground terminal block; 1 mm<sup>2</sup>; suitable for Ex e II applications;  
side and center marking; for DIN-rail 35 x 15 and 35 x 7.5; Push-in CAGE  
CLAMP®; 1,00 mm<sup>2</sup>; green-yellow

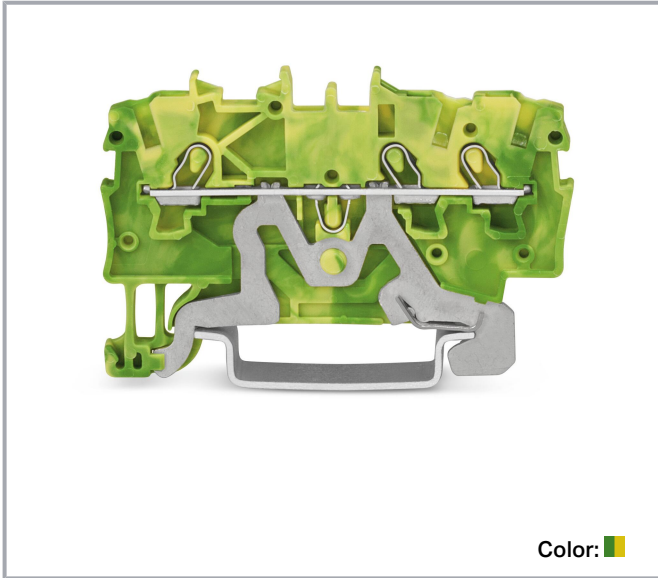

[www.wago.com/2000-1307](http://www.wago.com/2000-1307)



Color: 

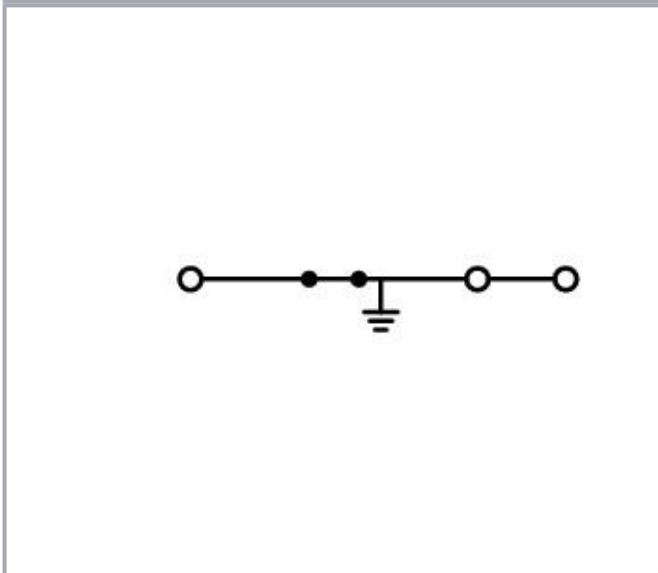
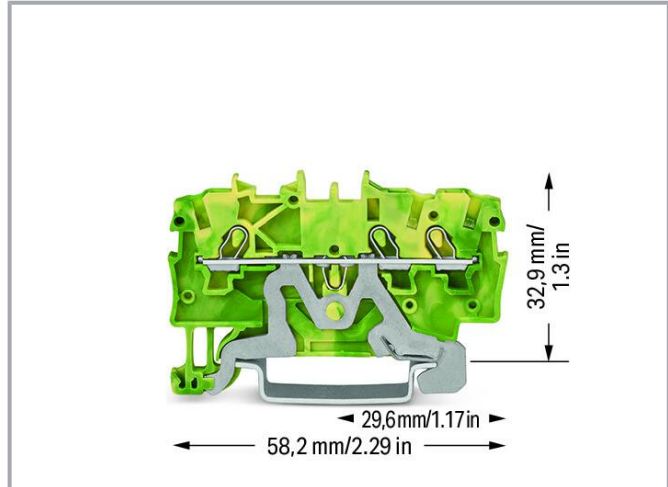

**Data**  
**Electrical data**

Subject to changes. Please also observe the further product documentation!

WAGO GmbH & Co. KG  
Hansastr. 27  
32423 Minden  
Phone: +49571 887-0 | Fax: +49571 887-169  
Email: [info.de@wago.com](mailto:info.de@wago.com) | Web: [www.wago.com](http://www.wago.com)

Do you have any questions about our products?  
We are always happy to take your call at +49 (571) 887-44222.

## Ratings per IEC/EN

Ratings per	IEC/EN 60947-7-2
-------------	------------------

## Ex information

Reference hazardous areas	See "Downloads – Documentation – Additional Information: Technical Section; Technical Explanations"
---------------------------	---

## Connection data

Connection points	3
Total number of potentials	1
Number of levels	1
Number of jumper slots	2

## Connection 1

Connection technology	Push-in CAGE CLAMP®
Actuation type	Operating tool
Connectable conductor materials	Copper
Nominal cross-section	1 mm <sup>2</sup>
Solid conductor	0.14 ... 1.5 mm <sup>2</sup> / 24 ... 16 AWG
Solid conductor; push-in termination	0.5 ... 1.5 mm <sup>2</sup> / 20 ... 16 AWG
Fine-stranded conductor	0.14 ... 1.5 mm <sup>2</sup> / 24 ... 16 AWG
Fine-stranded conductor; with insulated ferrule	0.14 ... 0.75 mm <sup>2</sup> / 24 ... 18 AWG
Fine-stranded conductor; with ferrule; push-in termination	0.5 ... 0.75 mm <sup>2</sup> / 20 ... 18 AWG
Note (conductor cross-section)	Depending on the conductor characteristic, a conductor with a smaller cross-section can also be inserted via push-in termination.
Strip length	9 ... 11 mm / 0.35 ... 0.43 inches
Wiring direction	Front-entry wiring

## Physical data

Width	3.5 mm / 0.138 inches
Height	58.2 mm / 2.291 inches
Depth from upper-edge of DIN-rail	32.9 mm / 1.295 inches

## Mechanical Data

Mounting type	DIN-35 rail
---------------	-------------

Subject to changes. Please also observe the further product documentation!



Marking level

Center/side marking

## Material Data

Note (material data)

Information on material specifications can be found here

Color	green-yellow
Material group	I
Insulation material	Polyamide (PA66)
Flammability class per UL94	V0
Fire load	0.083 MJ
Weight	6.5 g

## Environmental requirements

Processing temperature	-35 ... +85 °C
Continuous operating temperature	-60 ... +105 °C

## Commercial data

Product Group	22 (TOPJOB S)
eCl@ss 10.0	27-14-11-41
eCl@ss 9.0	27-14-11-41
ETIM 8.0	EC000901
ETIM 7.0	EC000901
PU (SPU)	100 pcs
Packaging type	box
Country of origin	CN
GTIN	4045454966904
Customs tariff number	85369010000

## Environmental Product Compliance

RoHS Compliance Status	Compliant, No Exemption
------------------------	-------------------------

## Approvals / Certificates

### General approvals





Logo	Approval	Additional Approval Text	Certificate name
	CCA DEKRA Certification B.V.	EN 60947	NTR NL 7962

Subject to changes. Please also observe the further product documentation!



WAGO GmbH & Co. KG  
Hansastr. 27  
32423 Minden  
Phone: +49571 887-0 | Fax: +49571 887-169  
Email: [info.de@wago.com](mailto:info.de@wago.com) | Web: [www.wago.com](http://www.wago.com)

Do you have any questions about our products?  
We are always happy to take your call at +49 (571) 887-44222.

CCA

	CCC CNEX	GB/T 3836.3	2020312313000182 (Ex eb IIC Gb, Ex eb I Mb)
	CSA DEKRA Certification B.V.	C22.2	2130762
	KEMA/KEUR DEKRA Certification B.V.	EN 60947	71-125928
	UL Underwriters Laboratories Inc.	UL 1059	E45172

## Declarations of conformity and manufacturer's declarations

Logo	Approval	Additional Approval Text	Certificate name
	EU-Declaration of Conformity WAGO GmbH & Co. KG	-	-
	Railway WAGO GmbH & Co. KG	-	Railway Ready
	UK-Declaration of Conformity WAGO GmbH & Co. KG	-	-



## Approvals for marine applications

Logo	Approval	Additional Approval Text	Certificate name
	ABS American Bureau of Shipping	EN 60947	20- HG1941090- PDA





Subject to changes. Please also observe the further product documentation!

WAGO GmbH & Co. KG  
 Hansastr. 27  
 32423 Minden  
 Phone: +49571 887-0 | Fax: +49571 887-169  
 Email: [info.de@wago.com](mailto:info.de@wago.com) | Web: [www.wago.com](http://www.wago.com)

Do you have any questions about our products?  
 We are always happy to take your call at +49 (571) 887-44222.

	<b>BV</b> Bureau Veritas S.A.	EN 60947	38586/B0 BV
	<b>DNV GL</b> Det Norske Veritas, Germanischer Lloyd	-	TAE00001V2
	<b>LR</b> Lloyds Register	EN 60947	91/20112 (E10)

## Approvals for hazardous areas

Logo	Approval	Additional Approval Text	Certificate name
	<b>AEx</b> Underwriters Laboratories Inc.	UL 60079	E185892 (AEx eb IIC resp. Ex eb IIC)
	<b>ATEX</b> Physikalisch Technische Bundesanstalt	EN 60079	PTB 11 ATEX 1041 U (II 2 G Ex eb IIC Gb bzw. I M 2 Ex eb I Mb)
	<b>CCC</b> CNEX	GB/T 3836.3	2020312313000182 (Ex eb IIC Gb, Ex eb I Mb)
	<b>EAC</b> Brjansker Zertifizierungsstelle	TP TC 012/2011	RU C-DE.AM02.B. 00127/19 (Ex e IIC Gb U)
	<b>IECEx</b> Physikalisch Technische Bundesanstalt	IEC 60079	IECEx PTB 11.0093U (Ex e IIC Gb or Ex e I Mb)

## Required accessories

## End plate

End plate



Item no.: 2000-1392

End and intermediate plate; 0.7 mm thick; orange

[www.wago.com/2000-1392](http://www.wago.com/2000-1392)

Subject to changes. Please also observe the further product documentation!

**Item no.: 2000-1391**

End and intermediate plate; 0.7 mm thick; gray

[www.wago.com/2000-1391](http://www.wago.com/2000-1391)

## Optional accessories

### Carrier rail

#### Mounting accessories

**Item no.: 210-197**

Steel carrier rail; 35 x 15 mm; 1.5 mm thick; 2 m long; slotted; similar to EN 60715; silver-colored

[www.wago.com/210-197](http://www.wago.com/210-197)**Item no.: 210-198**

Copper carrier rail; 35 x 15 mm; 2.3 mm thick; 2 m long; unslotted; according to EN 60715; copper-colored

[www.wago.com/210-198](http://www.wago.com/210-198)**Item no.: 210-113**

Steel carrier rail; 35 x 7.5 mm; 1 mm thick; 2 m long; unslotted; according to EN 60715; silver-colored

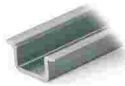
[www.wago.com/210-113](http://www.wago.com/210-113)**Item no.: 210-118**

Steel carrier rail; 35 x 15 mm; 2.3 mm thick; 2 m long; unslotted; according to EN 60715; silver-colored

[www.wago.com/210-118](http://www.wago.com/210-118)**Item no.: 210-112**Steel carrier rail; 35 x 7.5 mm; 1 mm thick; 2 m long; slotted; according to EN 60715; "Hole width 25 mm; silver-colored [www.wago.com/210-112](http://www.wago.com/210-112)**Item no.: 210-114**

Steel carrier rail; 35 x 15 mm; 1.5 mm thick; 2 m long; unslotted; similar to EN 60715; silver-colored

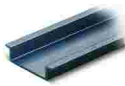
[www.wago.com/210-114](http://www.wago.com/210-114)**Item no.: 210-115**Steel carrier rail; 35 x 7.5 mm; 1 mm thick; 2 m long; slotted; according to EN 60715; "Hole width 18 mm; silver-colored [www.wago.com/210-115](http://www.wago.com/210-115)**Item no.: 210-196**

Aluminum carrier rail; 35 x 8.2 mm; 1.6 mm thick; 2 m long; unslotted; similar to EN 60715; silver-colored

[www.wago.com/210-196](http://www.wago.com/210-196)

### Testing and measuring

#### Testing accessories

**Item no.: 2009-174**

Test plug adapter; for 4 mm Ø test plugs; for testing TOPJOB®S rail-mounted terminal blocks; gray

[www.wago.com/2009-174](http://www.wago.com/2009-174)**Item no.: 2009-182**Testing tap; for max. 2.5 mm<sup>2</sup>; tool-free connection for individual test wires 0.08 - 2.5 mm; gray[www.wago.com/2009-182](http://www.wago.com/2009-182)**Item no.: 2000-510**TOPJOB®S L-type test plug module; modular; for jumper contact slot; 1,00 mm<sup>2</sup>; gray[www.wago.com/2000-510](http://www.wago.com/2000-510)**Item no.: 2000-511**TOPJOB®S L-type test plug module; modular; for jumper contact slot; 1-pole; 1,00 mm<sup>2</sup>; gray[www.wago.com/2000-511](http://www.wago.com/2000-511)

Subject to changes. Please also observe the further product documentation!

WAGO GmbH &amp; Co. KG

Hansastr. 27











32423 Minden

Phone: +49571 887-0 | Fax: +49571 887-169

Email: [info.de@wago.com](mailto:info.de@wago.com) | Web: [www.wago.com](http://www.wago.com)

Do you have any questions about our products?

We are always happy to take your call at +49 (571) 887-44222.

	<b>Item no.: 2000-549</b> Spacer module; modular; e.g., for bridging commoned terminal blocks; gray	<a href="http://www.wago.com/2000-549">www.wago.com/2000-549</a>
	<b>Item no.: 2000-555</b> Modular TOPJOB®S connector; modular; for jumper contact slot; 5-pole; 1,00 mm <sup>2</sup> ; gray	<a href="http://www.wago.com/2000-555">www.wago.com/2000-555</a>
	<b>Item no.: 2000-553</b> Modular TOPJOB®S connector; modular; for jumper contact slot; 3-pole; 1,00 mm <sup>2</sup> ; gray	<a href="http://www.wago.com/2000-553">www.wago.com/2000-553</a>
	<b>Item no.: 2000-556</b> Modular TOPJOB®S connector; modular; for jumper contact slot; 6-pole; 1,00 mm <sup>2</sup> ; gray	<a href="http://www.wago.com/2000-556">www.wago.com/2000-556</a>
	<b>Item no.: 2000-558</b> Modular TOPJOB®S connector; modular; for jumper contact slot; 8-pole; 1,00 mm <sup>2</sup> ; gray	<a href="http://www.wago.com/2000-558">www.wago.com/2000-558</a>
	<b>Item no.: 2000-559</b> Modular TOPJOB®S connector; modular; for jumper contact slot; 9-pole; 1,00 mm <sup>2</sup> ; gray	<a href="http://www.wago.com/2000-559">www.wago.com/2000-559</a>
	<b>Item no.: 2000-552</b> Modular TOPJOB®S connector; modular; for jumper contact slot; 2-pole; 1,00 mm <sup>2</sup> ; gray	<a href="http://www.wago.com/2000-552">www.wago.com/2000-552</a>
	<b>Item no.: 2000-560</b> Modular TOPJOB®S connector; modular; for jumper contact slot; 10-pole; 1,00 mm <sup>2</sup> ; gray	<a href="http://www.wago.com/2000-560">www.wago.com/2000-560</a>
	<b>Item no.: 2000-554</b> Modular TOPJOB®S connector; modular; for jumper contact slot; 4-pole; 1,00 mm <sup>2</sup> ; gray	<a href="http://www.wago.com/2000-554">www.wago.com/2000-554</a>
	<b>Item no.: 2000-557</b> Modular TOPJOB®S connector; modular; for jumper contact slot; 7-pole; 1,00 mm <sup>2</sup> ; gray	<a href="http://www.wago.com/2000-557">www.wago.com/2000-557</a>
	<b>Item no.: 210-136</b> Test plug; 2 mm Ø; with 500 mm cable; red	<a href="http://www.wago.com/210-136">www.wago.com/210-136</a>

### Mounting

#### Cover carrier



**Item no.: 709-169**  
Cover carrier; Type 3; gray

[www.wago.com/709-169](http://www.wago.com/709-169)

#### Cover



**Item no.: 709-156**  
Cover; Type 3; suitable for cover carrier, type 3; 1 m long; transparent

[www.wago.com/709-156](http://www.wago.com/709-156)

### Marking accessories

#### Marking strip















**Item no.: 2009-110**  
Marking strips; for Smart Printer; on reel; not stretchable; plain; snap-on type; white

[www.wago.com/2009-110](http://www.wago.com/2009-110)

#### Marker

Subject to changes. Please also observe the further product documentation!

	<b>Item no.: 2009-113</b> WMB-Inline; for Smart Printer; 2300 pieces on roll; plain; snap-on type; white	<a href="http://www.wago.com/2009-113">www.wago.com/2009-113</a>
	<b>Item no.: 2009-113/000-002</b> WMB-Inline; for Smart Printer; 2300 pieces on roll; plain; snap-on type; yellow	<a href="http://www.wago.com/2009-113/000-002">www.wago.com/2009-113/000-002</a>
	<b>Item no.: 2009-113/000-012</b> WMB-Inline; for Smart Printer; 2300 pieces on roll; plain; snap-on type; orange	<a href="http://www.wago.com/2009-113/000-012">www.wago.com/2009-113/000-012</a>
	<b>Item no.: 2009-113/000-007</b> WMB-Inline; for Smart Printer; 2300 pieces on roll; plain; snap-on type; gray	<a href="http://www.wago.com/2009-113/000-007">www.wago.com/2009-113/000-007</a>
	<b>Item no.: 2009-113/000-005</b> WMB-Inline; for Smart Printer; 2300 pieces on roll; plain; snap-on type; red	<a href="http://www.wago.com/2009-113/000-005">www.wago.com/2009-113/000-005</a>
	<b>Item no.: 2009-113/000-017</b> WMB-Inline; for Smart Printer; 2300 pieces on roll; plain; snap-on type; light green	<a href="http://www.wago.com/2009-113/000-017">www.wago.com/2009-113/000-017</a>
	<b>Item no.: 2009-113/000-006</b> WMB-Inline; for Smart Printer; 2300 pieces on roll; plain; snap-on type; blue	<a href="http://www.wago.com/2009-113/000-006">www.wago.com/2009-113/000-006</a>
	<b>Item no.: 2009-113/000-024</b> WMB-Inline; for Smart Printer; 2300 pieces on roll; plain; snap-on type; violet	<a href="http://www.wago.com/2009-113/000-024">www.wago.com/2009-113/000-024</a>
	<b>Item no.: 2009-113/000-023</b> WMB-Inline; for Smart Printer; 2300 pieces on roll; plain; snap-on type; green	<a href="http://www.wago.com/2009-113/000-023">www.wago.com/2009-113/000-023</a>
	<b>Item no.: 793-3501</b> WMB marking card; as card; plain; snap-on type; white	<a href="http://www.wago.com/793-3501">www.wago.com/793-3501</a>
Group marker carrier		
	<b>Item no.: 2009-191</b> Group marker carrier; gray	<a href="http://www.wago.com/2009-191">www.wago.com/2009-191</a>
Protective warning marker		
Cover		
	<b>Item no.: 2000-115</b> Protective warning marker; for 5 terminal blocks; with high-voltage symbol, black; yellow	<a href="http://www.wago.com/2000-115">www.wago.com/2000-115</a>
Jumpers		
Jumper		
	<b>Item no.: 210-123</b>	<a href="http://www.wago.com/210-123">www.wago.com/210-123</a>

Subject to changes. Please also observe the further product documentation!



Wire commoning chain; insulated; blue

	<b>Item no.: 2000-408</b> Jumper; 8-way; insulated; light gray	<a href="http://www.wago.com/2000-408">www.wago.com/2000-408</a>
	<b>Item no.: 2000-407</b> Jumper; 7-way; insulated; light gray	<a href="http://www.wago.com/2000-407">www.wago.com/2000-407</a>
	<b>Item no.: 2000-409</b> Jumper; 9-way; insulated; light gray	<a href="http://www.wago.com/2000-409">www.wago.com/2000-409</a>
	<b>Item no.: 2000-408/000-006</b> Jumper; 8-way; insulated; blue	<a href="http://www.wago.com/2000-408/000-006">www.wago.com/2000-408/000-006</a>
	<b>Item no.: 2000-408/000-005</b> Jumper; 8-way; insulated; red	<a href="http://www.wago.com/2000-408/000-005">www.wago.com/2000-408/000-005</a>
	<b>Item no.: 2000-409/000-005</b> Jumper; 9-way; insulated; red	<a href="http://www.wago.com/2000-409/000-005">www.wago.com/2000-409/000-005</a>
	<b>Item no.: 2000-407/000-006</b> Jumper; 7-way; insulated; blue	<a href="http://www.wago.com/2000-407/000-006">www.wago.com/2000-407/000-006</a>
	<b>Item no.: 2000-410</b> Jumper; 10-way; insulated; light gray	<a href="http://www.wago.com/2000-410">www.wago.com/2000-410</a>
	<b>Item no.: 2000-410/000-006</b> Jumper; 10-way; insulated; blue	<a href="http://www.wago.com/2000-410/000-006">www.wago.com/2000-410/000-006</a>
	<b>Item no.: 2000-433/000-005</b> Jumper; from 1 to 3; insulated; red	<a href="http://www.wago.com/2000-433/000-005">www.wago.com/2000-433/000-005</a>
	<b>Item no.: 2000-407/000-005</b> Jumper; 7-way; insulated; red	<a href="http://www.wago.com/2000-407/000-005">www.wago.com/2000-407/000-005</a>
	<b>Item no.: 2000-433/000-006</b> Jumper; from 1 to 3; insulated; blue	<a href="http://www.wago.com/2000-433/000-006">www.wago.com/2000-433/000-006</a>
	<b>Item no.: 2000-410/000-005</b> Jumper; 10-way; insulated; red	<a href="http://www.wago.com/2000-410/000-005">www.wago.com/2000-410/000-005</a>
	<b>Item no.: 2000-435</b>	

Subject to changes. Please also observe the further product documentation!

Jumper; from 1 to 5; insulated; light gray

[www.wago.com/2000-435](http://www.wago.com/2000-435)



**Item no.: 2000-409/000-006**  
Jumper; 9-way; insulated; blue

[www.wago.com/2000-409/000-006](http://www.wago.com/2000-409/000-006)



**Item no.: 2000-436**  
Jumper; from 1 to 6; insulated; light gray

[www.wago.com/2000-436](http://www.wago.com/2000-436)



**Item no.: 2000-433**  
Jumper; from 1 to 3; insulated; light gray

[www.wago.com/2000-433](http://www.wago.com/2000-433)



**Item no.: 2000-434**  
Jumper; from 1 to 4; insulated; light gray

[www.wago.com/2000-434](http://www.wago.com/2000-434)



**Item no.: 2000-402**  
Jumper; 2-way; insulated; light gray

[www.wago.com/2000-402](http://www.wago.com/2000-402)



**Item no.: 2000-402/000-006**  
Jumper; 2-way; insulated; blue

[www.wago.com/2000-402/000-006](http://www.wago.com/2000-402/000-006)



**Item no.: 2000-403**  
Jumper; 3-way; insulated; light gray

[www.wago.com/2000-403](http://www.wago.com/2000-403)



**Item no.: 2000-402/000-005**  
Jumper; 2-way; insulated; red

[www.wago.com/2000-402/000-005](http://www.wago.com/2000-402/000-005)



**Item no.: 2000-402/000-018**  
Jumper; 2-way; insulated; yellow-green

[www.wago.com/2000-402/000-018](http://www.wago.com/2000-402/000-018)



**Item no.: 2000-404**  
Jumper; 4-way; insulated; light gray

[www.wago.com/2000-404](http://www.wago.com/2000-404)



**Item no.: 2000-403/000-005**  
Jumper; 3-way; insulated; red

[www.wago.com/2000-403/000-005](http://www.wago.com/2000-403/000-005)



**Item no.: 2000-404/000-006**  
Jumper; 4-way; insulated; blue

[www.wago.com/2000-404/000-006](http://www.wago.com/2000-404/000-006)



**Item no.: 2000-403/000-006**  
Jumper; 3-way; insulated; blue

[www.wago.com/2000-403/000-006](http://www.wago.com/2000-403/000-006)



**Item no.: 2000-404/000-005**  
Jumper; 4-way; insulated; red

[www.wago.com/2000-404/000-005](http://www.wago.com/2000-404/000-005)



**Item no.: 2000-405**

Subject to changes. Please also observe the further product documentation!

Jumper; 5-way; insulated; light gray

[www.wago.com/2000-405](http://www.wago.com/2000-405)



**Item no.: 2000-405/011-000**  
Star point jumper; 3-way; insulated; light gray

[www.wago.com/2000-405/011-000](http://www.wago.com/2000-405/011-000)



**Item no.: 2000-405/000-006**  
Jumper; 5-way; insulated; blue

[www.wago.com/2000-405/000-006](http://www.wago.com/2000-405/000-006)



**Item no.: 2000-406/000-006**  
Jumper; 6-way; insulated; blue

[www.wago.com/2000-406/000-006](http://www.wago.com/2000-406/000-006)



**Item no.: 2000-405/000-005**  
Jumper; 5-way; insulated; red

[www.wago.com/2000-405/000-005](http://www.wago.com/2000-405/000-005)



**Item no.: 2000-406**  
Jumper; 6-way; insulated; light gray

[www.wago.com/2000-406](http://www.wago.com/2000-406)



**Item no.: 2000-406/000-005**  
Jumper; 6-way; insulated; red

[www.wago.com/2000-406/000-005](http://www.wago.com/2000-406/000-005)



**Item no.: 2000-406/020-000**  
Delta jumper; insulated; light gray

[www.wago.com/2000-406/020-000](http://www.wago.com/2000-406/020-000)



**Item no.: 2000-437**  
Jumper; from 1 to 7; insulated; light gray

[www.wago.com/2000-437](http://www.wago.com/2000-437)



**Item no.: 2000-438**  
Jumper; from 1 to 8; insulated; light gray

[www.wago.com/2000-438](http://www.wago.com/2000-438)



**Item no.: 2000-439**  
Jumper; from 1 to 9; insulated; light gray

[www.wago.com/2000-439](http://www.wago.com/2000-439)



**Item no.: 2000-440**  
Jumper; from 1 to 10; insulated; light gray

[www.wago.com/2000-440](http://www.wago.com/2000-440)

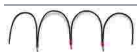

**Item no.: 210-103**  
Wire commoning chain; insulated; black

[www.wago.com/210-103](http://www.wago.com/210-103)

**Push-in type wire jumper**

Jumper



**Item no.: 2009-404**  
Push-in type wire jumper; 0.75 mm<sup>2</sup>; insulated; 110 mm long; gray

[www.wago.com/2009-404](http://www.wago.com/2009-404)

Subject to changes. Please also observe the further product documentation!



**Item no.: 2009-402**  
Push-in type wire jumper; 0.75 mm<sup>2</sup>; insulated; 60 mm long; gray

[www.wago.com/2009-402](http://www.wago.com/2009-402)



**Item no.: 2009-406**  
Push-in type wire jumper; 0.75 mm<sup>2</sup>; insulated; 250 mm long; gray

[www.wago.com/2009-406](http://www.wago.com/2009-406)

## Ferrule

### Ferrule



**Item no.: 216-241**  
Ferrule; Sleeve for 0.5 mm<sup>2</sup> / 20 AWG; insulated; electro-tin plated; electrolytic copper; gastight crimped; acc. to DIN 46228, Part 4/09.90; white

[www.wago.com/216-241](http://www.wago.com/216-241)



**Item no.: 216-242**  
Ferrule; Sleeve for 0.75 mm<sup>2</sup> / 18 AWG; insulated; electro-tin plated; electrolytic copper; gastight crimped; acc. to DIN 46228, Part 4/09.90; gray

[www.wago.com/216-242](http://www.wago.com/216-242)



**Item no.: 216-243**  
Ferrule; Sleeve for 1 mm<sup>2</sup> / AWG 18; insulated; electro-tin plated; electrolytic copper; gastight crimped; acc. to DIN 46228, Part 4/09.90; red

[www.wago.com/216-243](http://www.wago.com/216-243)

## Tool

### Operating tool



**Item no.: 210-648**  
Operating tool; Blade: 2.5 x 0.4 mm; with a partially insulated shaft; angled; short

[www.wago.com/210-648](http://www.wago.com/210-648)



**Item no.: 210-647**  
Operating tool; Blade: 2.5 x 0.4 mm; with a partially insulated shaft; multicoloured

[www.wago.com/210-647](http://www.wago.com/210-647)



**Item no.: 210-719**  
Operating tool; Blade: 2.5 x 0.4 mm; with a partially insulated shaft

[www.wago.com/210-719](http://www.wago.com/210-719)

## Downloads

### Documentation

#### Bid Text

2000-1307 X81 - Datei	2019 Feb 19	xml 3.7 kB	Download
2000-1307 docx - Datei	2018 Aug 7	docx 14.8 kB	Download

#### Additional Information

Technical Section Technical explanations	pdf 2.2 MB	Download
---	---------------	----------

Subject to changes. Please also observe the further product documentation!

WAGO GmbH & Co. KG  
Hansastr. 27  
32423 Minden  
Phone: +49571 887-0 | Fax: +49571 887-169  
Email: [info.de@wago.com](mailto:info.de@wago.com) | Web: [www.wago.com](http://www.wago.com)

Do you have any questions about our products?  
We are always happy to take your call at +49 (571) 887-44222.

## CAD/CAE-Data

### CAD data

2D/3D Models 2000-1307	<a href="#">URL</a>	<a href="#">Download</a>
------------------------	---------------------	--------------------------

### CAE data

EPLAN Data Portal 2000-1307	<a href="#">URL</a>	<a href="#">Download</a>
-----------------------------	---------------------	--------------------------

WSCAD Universe 2000-1307	<a href="#">URL</a>	<a href="#">Download</a>
--------------------------	---------------------	--------------------------

ZUKEN Portal 2000-1307	<a href="#">URL</a>	<a href="#">Download</a>
------------------------	---------------------	--------------------------

## Environmental Product Compliance

### Compliance Search

Environmental Product Compliance 2000-1307	<a href="#">URL</a>	<a href="#">Download</a>
--	---------------------	--------------------------

3-conductor ground terminal block; 1 mm<sup>2</sup>; suitable for Ex e II applications; side and center marking; for DIN-rail 35 x 15 and 35 x 7.5; Push-in CAGE CLAMP®; 1,00 mm<sup>2</sup>; green-yellow

## Installation Notes

### Conductor termination

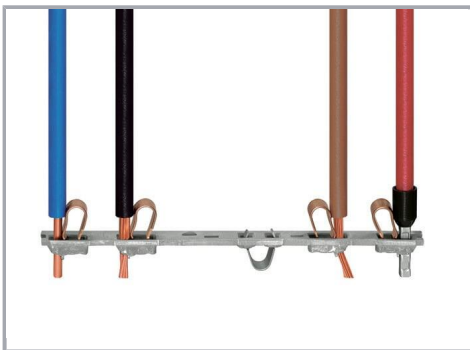

All conductor types at a glance

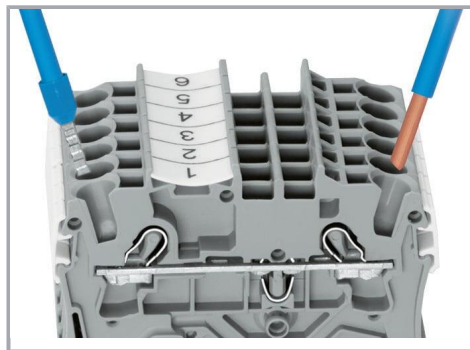

Push-in termination of solid and ferruled conductors

Subject to changes. Please also observe the further product documentation!

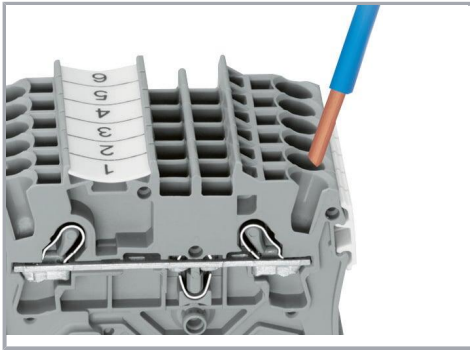

**Inserting a conductor via push-in termination:**

Solid conductors with cross-sections from either one size above, or up to two sizes below, the rated cross-section can be simply pushed in – no tools needed.

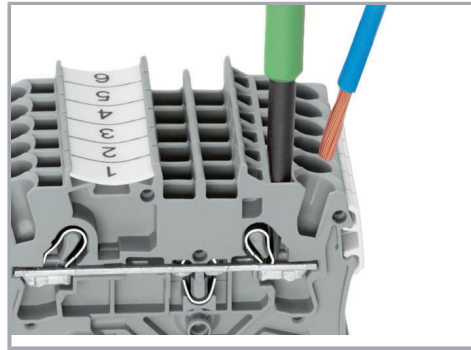

**Inserting a conductor via operating tool:**

Connecting fine-stranded conductors without ferrules, or small cross-sectional conductors that cannot be pushed in, is performed similarly to the original CAGE CLAMP® – just use an operating tool.

**Advantage:**

To open the clamp, the operating tool is inserted vertically. The conductor entry is less than 15 degrees for easier wiring.

**Commoning**

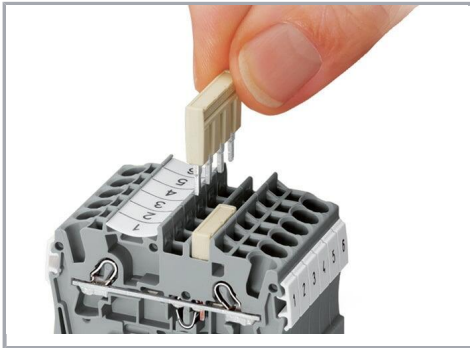

Insert push-in type jumper bar and push down until it hits backstop.

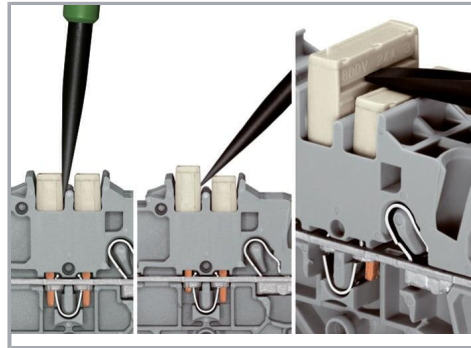

**Removing a push-in type jumper bar:**

Insert the operating tool between the jumper and partition wall of the dual jumper slots, then lift up the jumper.

Place the operating tool in the center of jumpers for up to five contacts (see above), or alternately on both sides for jumpers with more than five contacts.

Subject to changes. Please also observe the further product documentation!

### Commoning

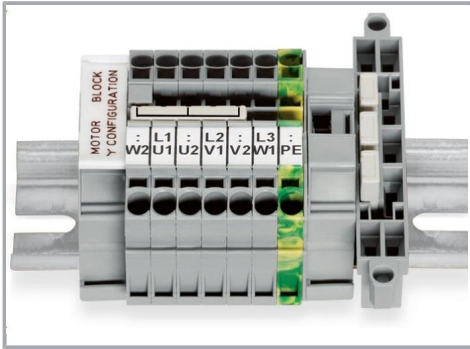

This star point jumper has been specially developed to create a "star point" and is used on motor terminal boards equipped with Rail-Mount Terminal Blocks TOPJOB® S.

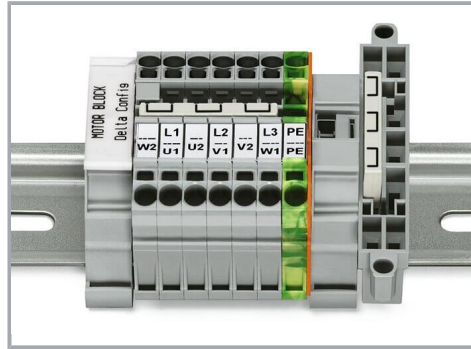

This delta jumper has been specially developed to create a delta configuration and is used on motor terminal boards equipped with rail-mount terminal blocks TOPJOB® S.

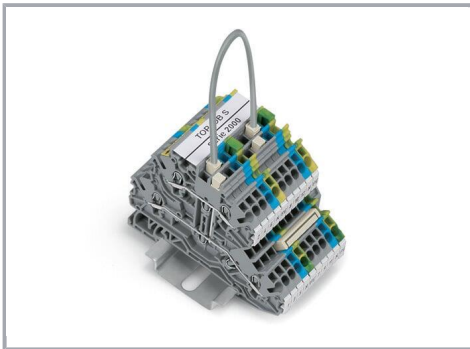

Push down the wire jumper (2009-402) until fully inserted. For rewiring, lift the jumper with an operating tool at the notch provided for this purpose on the jumper.

### Testing

Subject to changes. Please also observe the further product documentation!

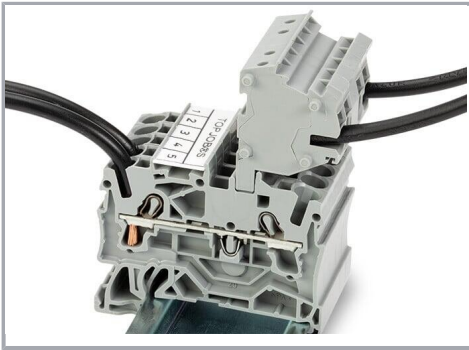

The modular TOPJOB® S connectors also connect conductors of the same size as the terminal blocks being used.

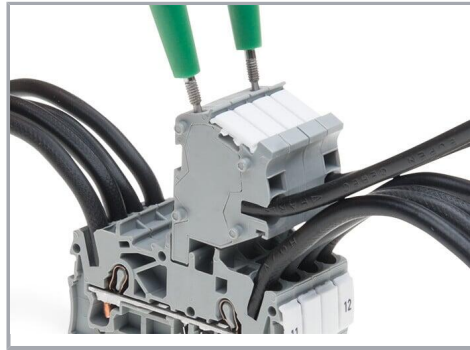

TOPJOB® S Connectors with a 2 mm Ø test socket for testing voltage via 2-pole voltage tester

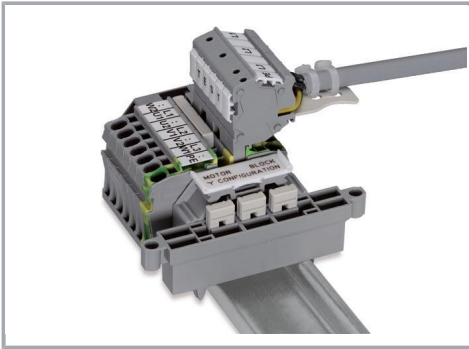

Rail-mount terminal block assembly for electric motor wiring



Test plug adapter (2009-174, CAT I) for 4 mm Ø plugs – compatible with 2000 to 2016 Series

Subject to changes. Please also observe the further product documentation!



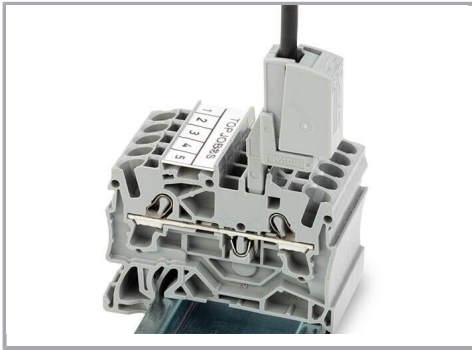

Testing tap (2009-182) for tool-free connection of test cables up to 2.5 mm<sup>2</sup> (12 AWG) – compatible with 2000 to 2016 Series

### Marking

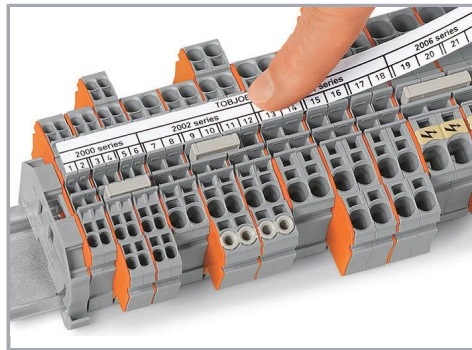
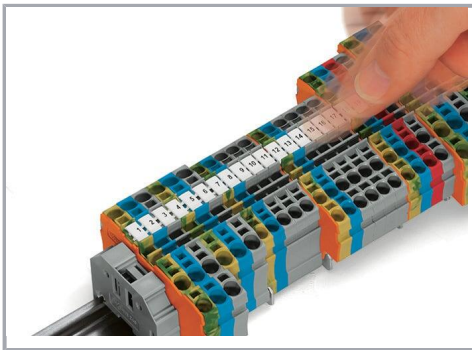

Snapping WMB Inline markers into marker slots.

Subject to changes. Please also observe the further product documentation!

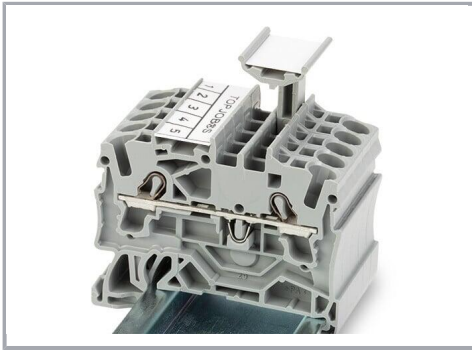

TOPJOB® S 2009-193 Group Marker Carrier (equipped with a marking strip) for all 2001 to 2016 Series TOPJOB® S Rail-Mount Terminal Blocks

Do not use on an end plate!

## Product family

### TOPJOB® S

TOPJOB® S: In various industrial applications and modern building installations, WAGO's wide and versatile range of rail-mount terminal blocks provides more than just reliable electrical connections.

[Show all products from the family](#)

Subject to changes. Please also observe the further product documentation!