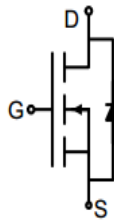
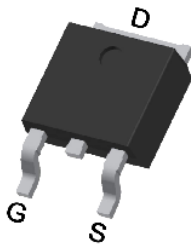

N-Channel Enhancement Mode Power MOSFET

| | | | |
|---|----------------|--|------------------|
| <p>Description</p> <p>The G25N06K uses advanced trench technology to provide excellent $R_{DS(ON)}$, low gate charge. It can be used in a wide variety of applications.</p> <p>General Features</p> <ul style="list-style-type: none"> • V_{DS} 60V • I_D (at $V_{GS} = 10V$) 25A • $R_{DS(ON)}$ (at $V_{GS} = 10V$) < 27mΩ • 100% Avalanche Tested • RoHS Compliant <p>Application</p> <ul style="list-style-type: none"> • Power switch • DC/DC converters | |  <p>Schematic diagram</p>  <p>TO-252</p> | |
| Device | Package | Marking | Packaging |
| G25N06K | TO-252 | G25N06 | 2500pcs/Reel |

| Absolute Maximum Ratings $T_C = 25^{\circ}C$, unless otherwise noted | | | |
|---|----------------|------------|------|
| Parameter | Symbol | Value | Unit |
| Drain-Source Voltage | V_{DS} | 60 | V |
| Continuous Drain Current | I_D | 25 | A |
| Pulsed Drain Current (note1) | I_{DM} | 80 | A |
| Gate-Source Voltage | V_{GS} | ±20 | V |
| Power Dissipation | P_D | 45 | W |
| Single pulse avalanche energy (note3) | E_{AS} | 25 | mJ |
| Operating Junction and Storage Temperature Range | T_J, T_{stg} | -55 To 150 | °C |
| Thermal Resistance | | | |
| Parameter | Symbol | Value | Unit |
| Thermal Resistance, Junction-to-Case | R_{thJC} | 3.3 | °C/W |

| Specifications $T_J = 25^\circ\text{C}$, unless otherwise noted | | | | | | |
|--|---------------|---|-------|------|-----------|------------|
| Parameter | Symbol | Test Conditions | Value | | | Unit |
| | | | Min. | Typ. | Max. | |
| Static Parameters | | | | | | |
| Drain-Source Breakdown Voltage | $V_{(BR)DSS}$ | $V_{GS} = 0V, I_D = 250\mu A$ | 60 | -- | -- | V |
| Zero Gate Voltage Drain Current | I_{DSS} | $V_{DS} = 60V, V_{GS} = 0V$ | -- | -- | 1 | μA |
| Gate-Source Leakage | I_{GSS} | $V_{GS} = \pm 20V$ | -- | -- | ± 100 | nA |
| Gate-Source Threshold Voltage | $V_{GS(th)}$ | $V_{DS} = V_{GS}, I_D = 250\mu A$ | 1 | 1.5 | 2.5 | V |
| Drain-Source On-Resistance | $R_{DS(on)}$ | $V_{GS} = 10V, I_D = 20A$ | -- | 20 | 27 | m Ω |
| Forward Transconductance | g_{FS} | $V_{DS}=5V, I_D=10A$ | 11 | -- | -- | S |
| Dynamic Parameters | | | | | | |
| Input Capacitance | C_{iss} | $V_{GS} = 0V,$ $V_{DS} = 30V,$ $f = 1.0MHz$ | -- | 970 | -- | pF |
| Output Capacitance | C_{oss} | | -- | 60 | -- | |
| Reverse Transfer Capacitance | C_{rss} | | -- | 59 | -- | |
| Total Gate Charge | Q_g | $V_{DD} = 30V,$ $I_D = 10A,$ $V_{GS} = 10V$ | -- | 25 | -- | nC |
| Gate-Source Charge | Q_{gs} | | -- | 4.5 | -- | |
| Gate-Drain Charge | Q_{gd} | | -- | 6.5 | -- | |
| Turn-on Delay Time | $t_{d(on)}$ | $V_{DD} = 30V,$ $I_D = 10A,$ $R_G = 3\Omega$ | -- | 7 | -- | ns |
| Turn-on Rise Time | t_r | | -- | 20 | -- | |
| Turn-off Delay Time | $t_{d(off)}$ | | -- | 16 | -- | |
| Turn-off Fall Time | t_f | | -- | 23 | -- | |
| Drain-Source Body Diode Characteristics | | | | | | |
| Continuous Body Diode Current | I_S | $T_C = 25^\circ\text{C}$ | -- | -- | 25 | A |
| Body Diode Voltage | V_{SD} | $T_J = 25^\circ\text{C}, I_{SD} = 20A, V_{GS} = 0V$ | -- | -- | 1.2 | V |
| Reverse Recovery Time | T_{rr} | $I_S = 10A, V_{GS} = 0V$ $di/dt=100A/us$ | -- | 29 | -- | ns |

Notes

1. Repetitive Rating: Pulse width limited by maximum junction temperature
2. Identical low side and high side switch with identical R_G .
3. EAS condition : $T_J=25^\circ\text{C}$, $V_{DD}=50V, V_{GS}=10V, L=0.5mH, R_g=25\Omega$

Gate Charge Test Circuit

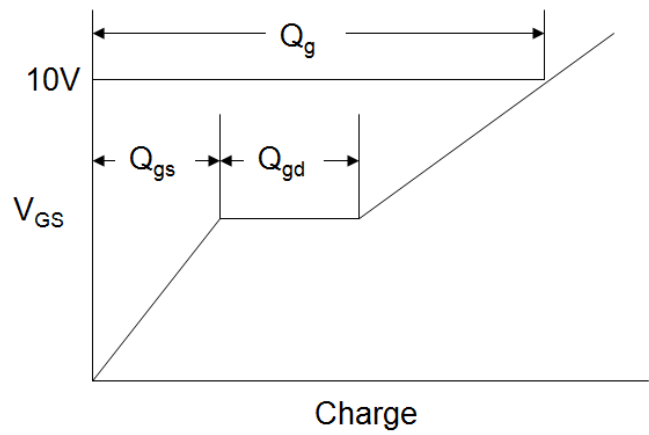

Switch Time Test Circuit

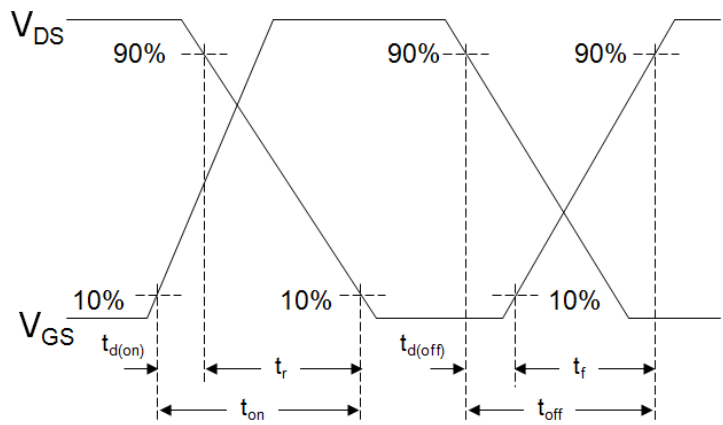

EAS Test Circuit

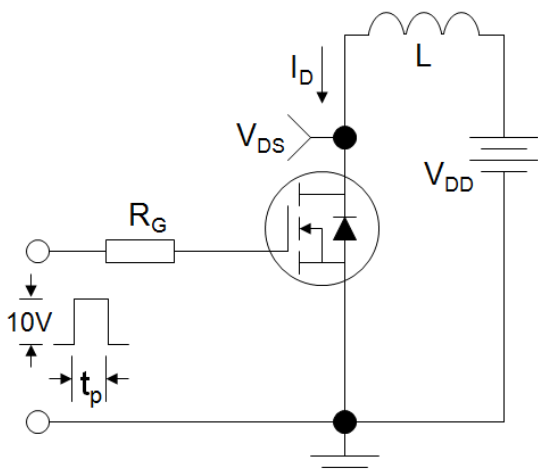

Typical Characteristics $T_J = 25^\circ\text{C}$, unless otherwise noted

Figure 1. Output Characteristics

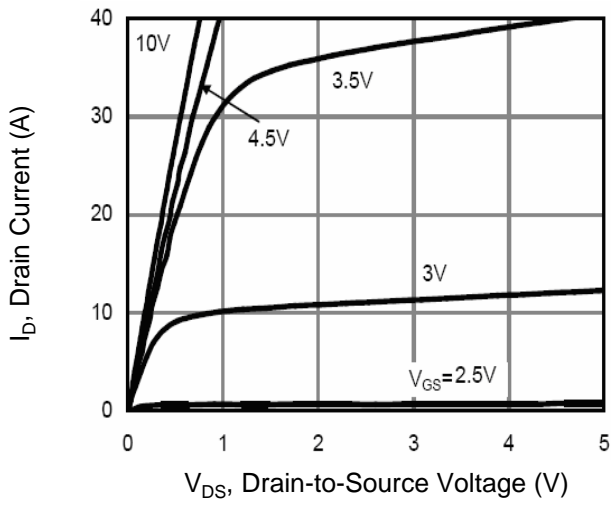

Figure 2. Transfer Characteristics

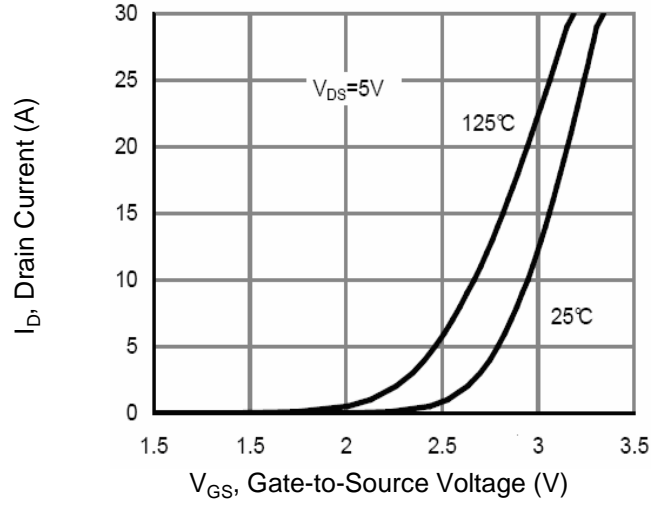

Figure 3. Gate Charge

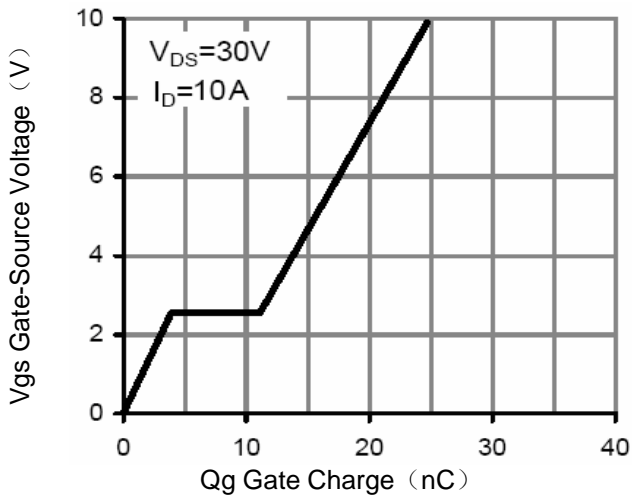

Figure 4. Drain Source On Resistance

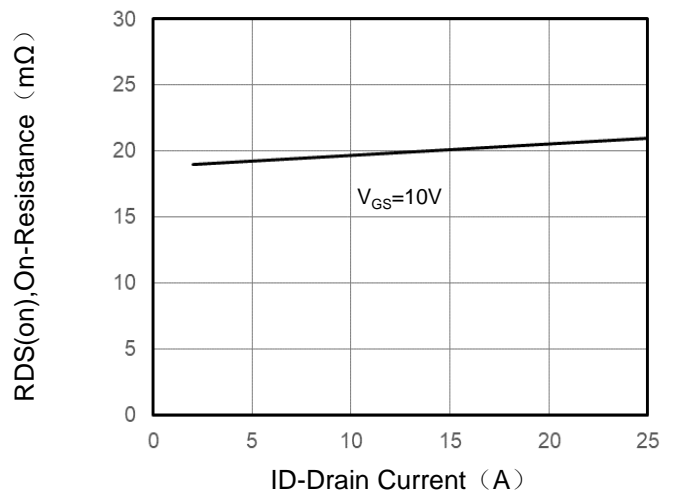

Figure 5. Capacitance

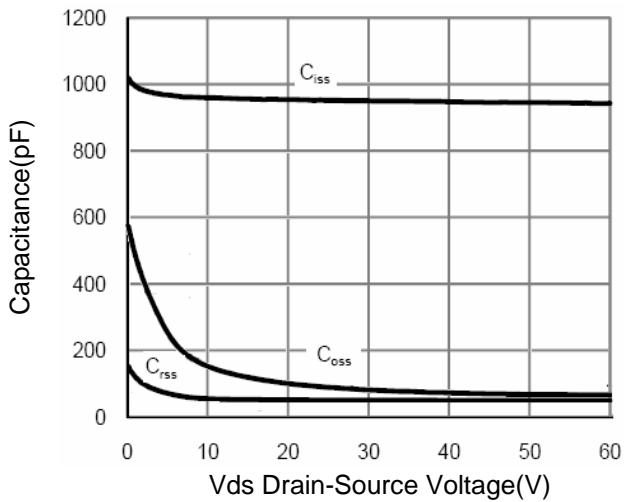
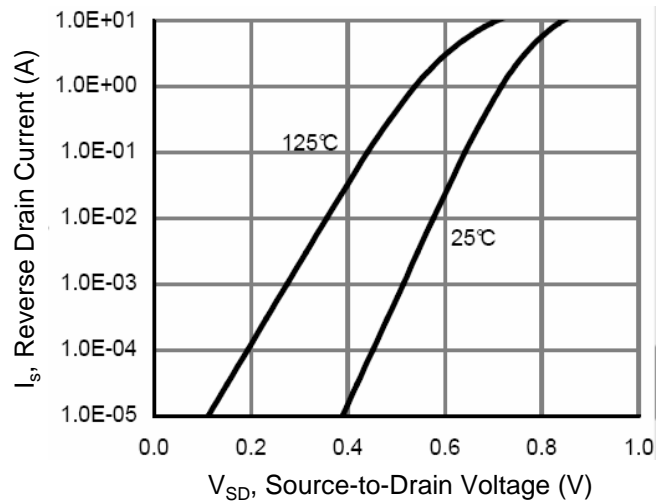

Figure 6. Source-Drain Diode Forward



Typical Characteristics $T_J = 25^\circ\text{C}$, unless otherwise noted

Figure 7. Drain-Source On-Resistance

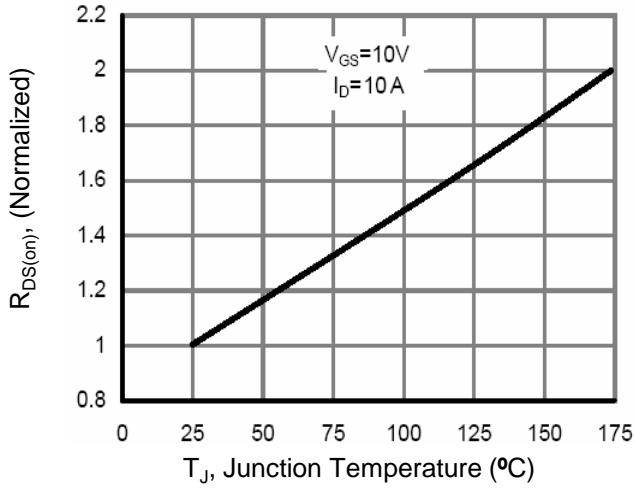

Figure 8. Safe Operation Area

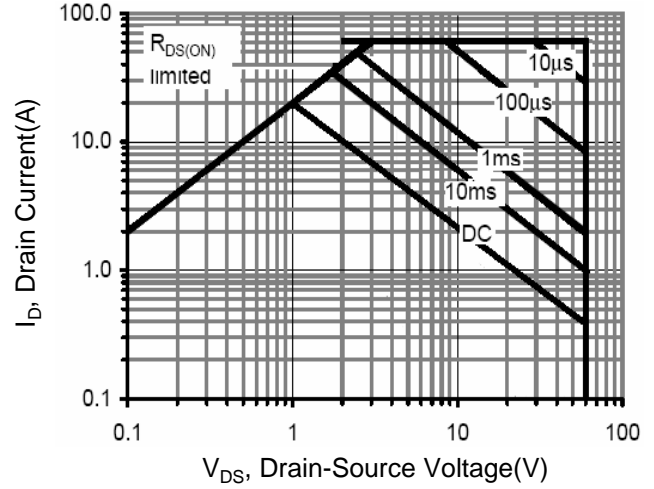
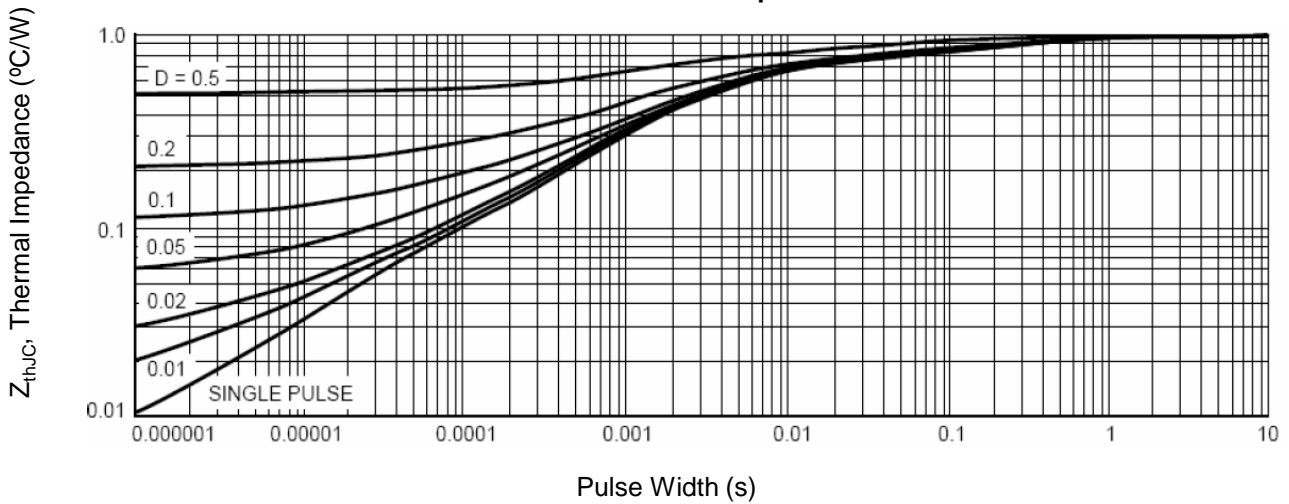
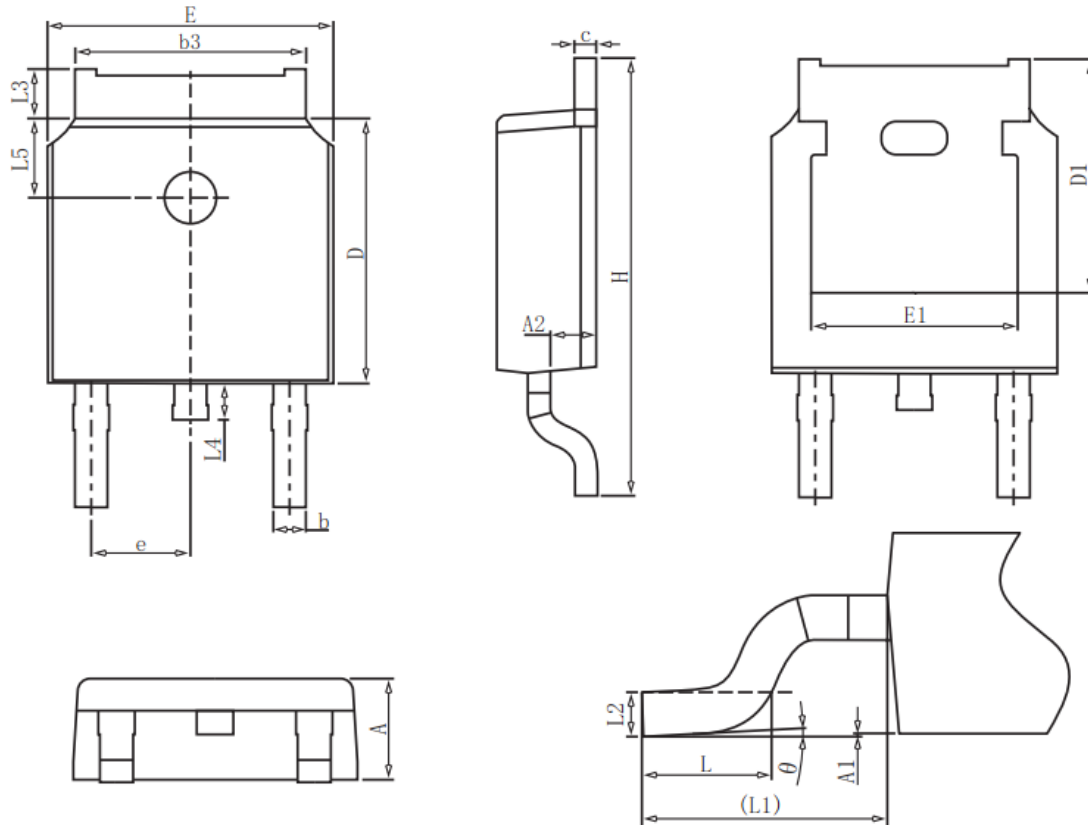

Figure 9. Normalized Maximum Transient Thermal Impedance



TO-252 Package Information



| Symbol | Dimensions in Millimeters | | |
|--------|---------------------------|------|------|
| | MIN. | NOM. | MAX. |
| A | 2.2 | 2.3 | 2.4 |
| A1 | 0 | | 0.2 |
| A2 | 0.97 | 1.07 | 1.17 |
| b | 0.68 | 0.78 | 0.9 |
| b3 | 5.2 | 5.33 | 5.5 |
| c | 0.43 | 0.53 | 0.63 |
| D | 5.98 | 6.1 | 6.22 |
| D1 | 5.30REF | | |
| E | 6.4 | 6.6 | 6.8 |
| E1 | 4.63 | | |
| e | 2.286BSC | | |
| H | 9.4 | 10.1 | 10.5 |
| L | 1.38 | 1.5 | 1.75 |
| L1 | 2.90REF | | |
| L2 | 0.51BSC | | |
| L3 | 0.88 | | 1.28 |
| L4 | 0.5 | | 1 |
| L5 | 1.65 | 1.8 | 1.95 |
| θ | 0° | | 8° |