

MATERIAL NUMBER	# OF COLUMNS	# OF DIFF PAIR	DIM "A" MAX	DIM "B"	PTH#
76560-1**	10	60	26.60	17.10	0.46+0.05
76560-7**	14	84	34.20	24.70	0.46+0.05
76560-6**	16	96	38.00	28.50	0.46+0.05
76560-1**	10	60	26.60	17.10	0.39+0.05
76560-7**	14	84	34.20	24.70	0.39+0.05
76560-6**	16	96	38.00	28.50	0.39+0.05

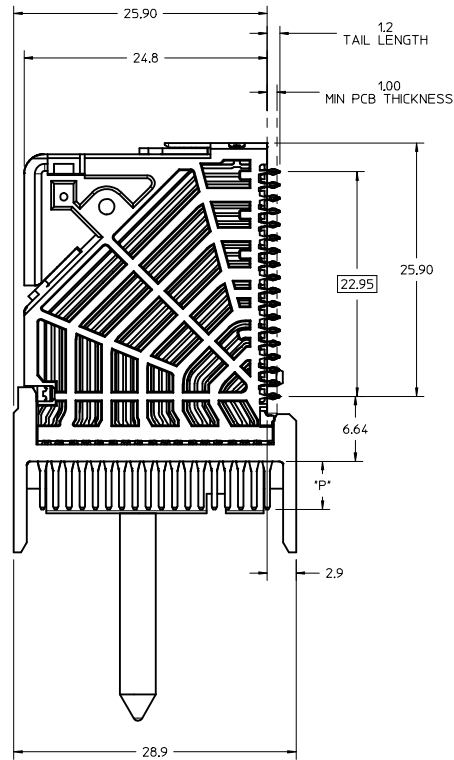
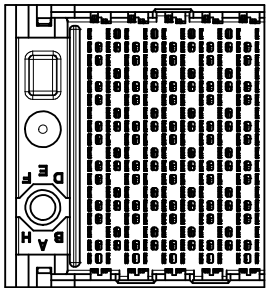
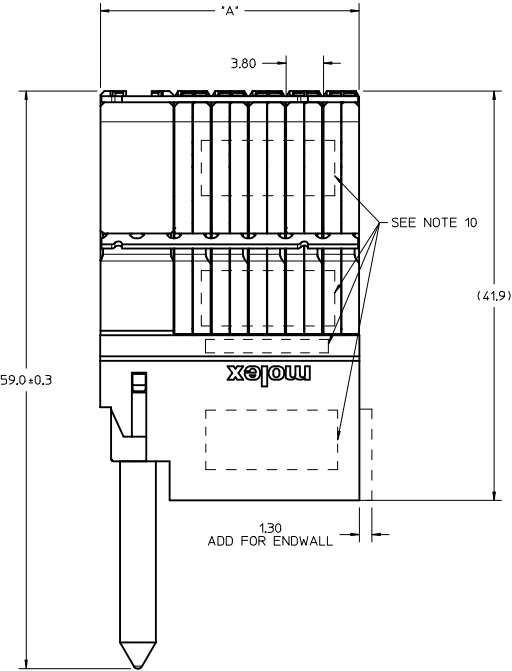

76560-\*\*\*\*

MODULE TYPE  
 3 = GUIDED, LEAD-FREE  
 7 = GUIDED, LEAD-FREE W/ENDWALL

# OF COLUMNS  
 1 = 10 COLUMNS  
 6 = 16 COLUMNS  
 7 = 14 COLUMNS

PIN LENGTH (P)  
 4 = 4.90 (0.46 PTH)  
 5 = 5.50 (0.46 PTH)  
 7 = 4.90 (0.39 PTH)  
 8 = 5.50 (0.39 PTH)

KEY ORIENTATION  
 0 = NO KEY  
 1 = A  
 2 = B  
 3 = C  
 4 = D  
 5 = E  
 6 = F  
 7 = G  
 8 = H

- NOTES:
- MATERIALS: HOUSING - LIQUID CRYSTAL POLYMER (LCP), GLASS-FILLED, UL94V-0  
 TERMINALS - HIGH PERFORMANCE COPPER ALLOY
  - FINISH: 30μN SELECTIVE GOLD IN CONTACT AREA, SELECTIVE TIN ON PCB TAILS, NICKEL OVERALL.
  - REFER TO MOLEX PRODUCT SPECIFICATION PS-76060-999 FOR PERFORMANCE SPECIFICATIONS AND ADDITIONAL PCB INFORMATION.
  - EACH SIGNAL WAFER CONTAINS 2 COLUMNS OF TERMINALS.
  - PRODUCT IS PACKAGED PER PK-70873-777.
  - THIS PART CONFORMS TO CLASS B REQUIREMENTS OF COSMETIC SPEC PS-45499-002.
  - REFER TO MOLEX SALES DRAWING SD-76150-004 FOR THE MATING RECEPTACLES.
  - REFER TO MOLEX PCB ROUTING GUIDE AS-76060-990 FOR ANTIPAD AND ROUTING RECOMMENDATIONS.
  - WHEN USING A MOLEX SUPPLIED #2-32 SCREW 73726-0000 (9.50mm +/- 0.38 THREADABLE SCREW LENGTH) THE MAXIMUM BOARD THICKNESS IS 4.4MM.
  - MARKING LOCATED APPROXIMATELY AS SHOWN, PART NUMBER AND DATE CODE.
  - THESE DIMENSIONS REPRESENT THE AREA NEEDED TO ACCOMMODATE CONNECTOR INSERTION AND REPAIR ON THE PCB. THIS IS REFERRED TO AS THE 'CONNECTOR KEEP OUT ZONE' AND DOES NOT REPRESENT THE ACTUAL PERIMETER OF THE CONNECTOR.

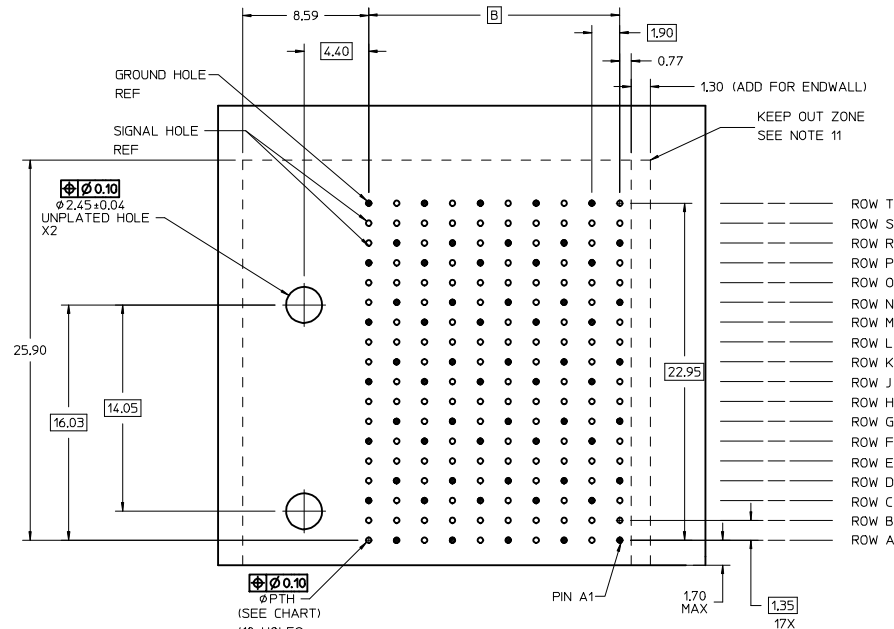

RAM HOLE PATTERN  
(CONNECTOR SIDE)

UPD PAGE 2 PCB VIEW IEC NO. UCP2017-1613 DRAWN: GONZALEZ01 2017/01/20 CHKD: APPR: TELO REV:	QUALITY SYMBOLS	GENERAL TOLERANCES (UNLESS SPECIFIED)	DIMENSION STYLE MM ONLY	SCALE 4:1	DESIGN UNITS METRIC	THIRD ANGLE PROJECTION
	▽=0 ▽=0 ▽=0	4 PLACES ± --- ± --- 3 PLACES ± --- ± --- 2 PLACES ± 0.13 ± --- 1 PLACE ± 0.25 ± --- 0 PLACE ± --- ± ---	mm      INCH ± ---      ± --- ± 0.13   ± --- ± 0.25   ± --- ± ---    ± ---	DRAWN BY      DATE JGONZALEZ01 2015/06/25 CHECKED BY    DATE	TITLE	IMPACT 6 PAIR RAM MARRIED GUIDE LEFT SALES DRAWING
	ANGULAR ±1/2° DRAFT WHERE APPLICABLE MUST REMAIN WITHIN DIMENSIONS		MATERIAL NO. SEE TABLE	APPROVED BY      DATE TELO                      2016/01/10	DOCUMENT NO. SD-76560-9002	SHEET NO. 1 OF 2
			SIZE D	THIS DRAWING CONTAINS INFORMATION THAT IS PROPRIETARY TO MOLEX INCORPORATED AND SHOULD NOT BE USED WITHOUT WRITTEN PERMISSION		

20 19 18 17 16 15 14 13 12 11 10 9 8 7 6 5 4 3 2 1

COPLANAR APPLICATION

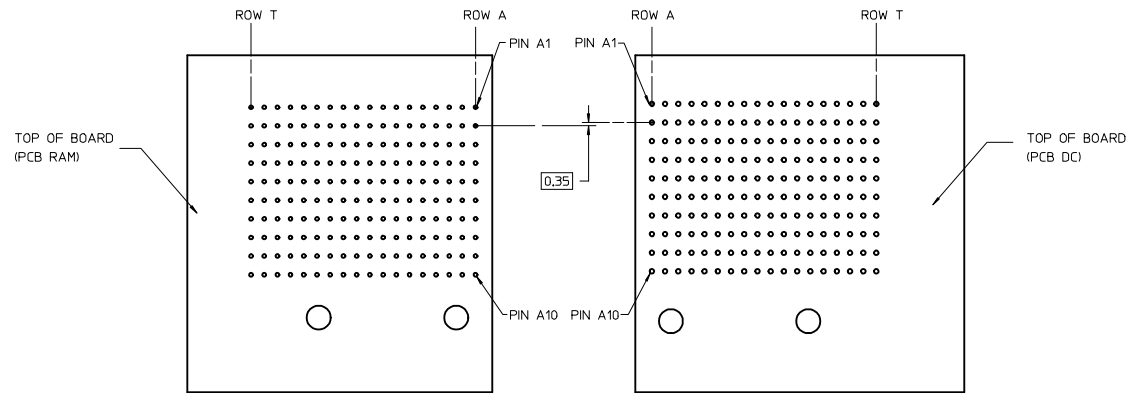
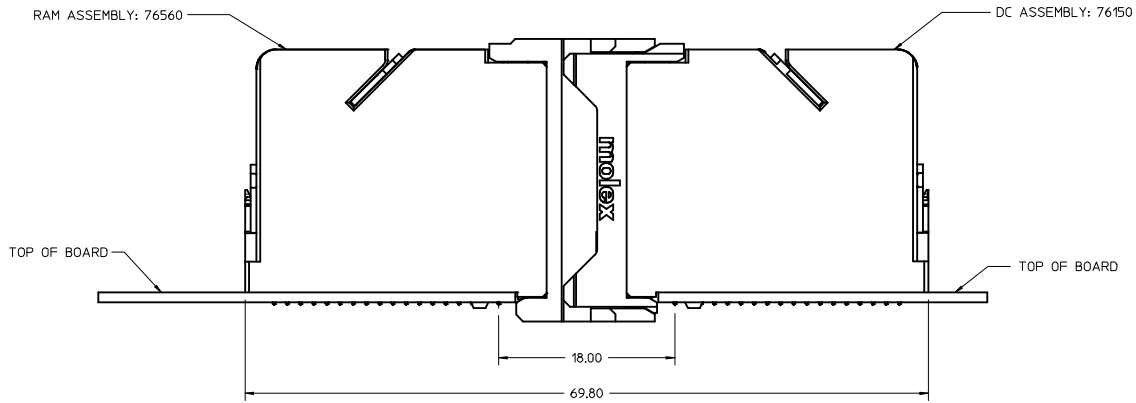

COPLANER MATED SIGNAL PATHS

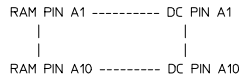

SEE SHEET 1 IEC NO. UCP2017-1613 DRAWN: GONZALEZ01 2017/01/20 CHKD: TELLO APPR: TELLO REV:	QUALITY SYMBOLS	GENERAL TOLERANCES (UNLESS SPECIFIED)	DIMENSION STYLE	SCALE	DESIGN UNITS	THIRD ANGLE PROJECTION
	▽=0	mm INCH	MM ONLY	4:1	METRIC	☉
	▽=0	4 PLACES ± --- ± ---	DRAWN BY	DATE	TITLE	IMPACT 6 PAIR RAM MARRIED GUIDE LEFT SALES DRAWING <b>molex</b>
	▽=0	3 PLACES ± --- ± ---	JGONZALEZ01	2015/06/25	2016/01/10	
▽=0	2 PLACES ± 0.13 ± ---	CHECKED BY	DATE	APPROVED BY	DATE	DOCUMENT NO.
	1 PLACE ± 0.25 ± ---	TELO	2016/01/10	TELO	2016/01/10	SD-76560-9002
	0 PLACE ± --- ± ---	ANGULAR ±1/2°	MATERIAL NO.	SEE CHART	SIZE	SHEET NO.
	DRAFT WHERE APPLICABLE MUST REMAIN WITHIN DIMENSIONS					2 OF 2
			THIS DRAWING CONTAINS INFORMATION THAT IS PROPRIETARY TO MOLEX INCORPORATED AND SHOULD NOT BE USED WITHOUT WRITTEN PERMISSION			

19 18 17 16 15 14 13 12 11 10 9 8 7 6 5 4 3 2 1

MATERIAL NUMBER	# OF COLUMNS	# OF DIFF PAIR	DIM "A" MAX	DIM "B"	PTH#
76560-1**	10	60	26.60	17.10	0.46+0.05
76560-7**	14	84	34.20	24.70	0.46+0.05
76560-6**	16	96	38.00	28.50	0.46+0.05
76560-1**	10	60	26.60	17.10	0.39+0.05
76560-7**	14	84	34.20	24.70	0.39+0.05
76560-6**	16	96	38.00	28.50	0.39+0.05

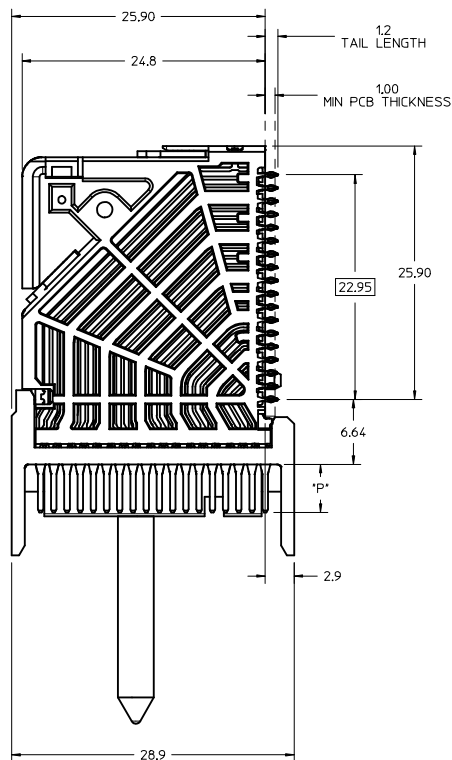
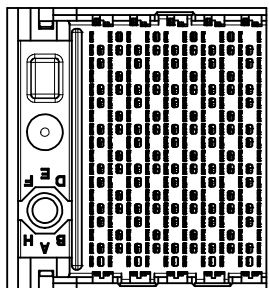
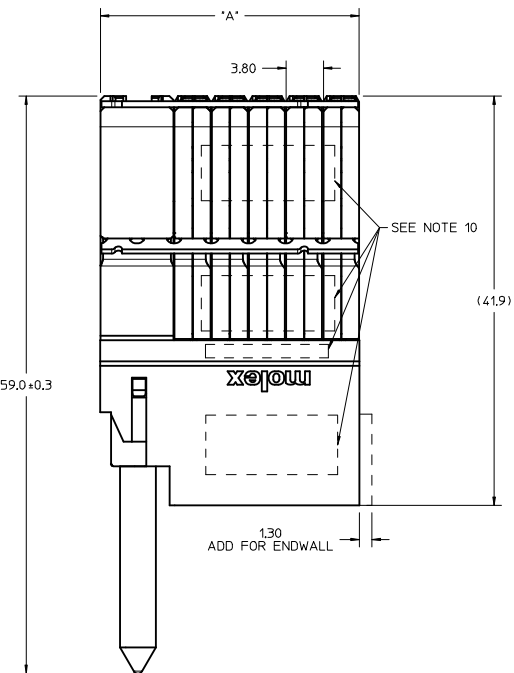

76560-\*\*\*\*

MODULE TYPE  
 3 = GUIDED, LEAD-FREE  
 7 = GUIDED, LEAD-FREE W/ENDWALL

# OF COLUMNS  
 1 = 10 COLUMNS  
 6 = 16 COLUMNS  
 7 = 14 COLUMNS

PIN LENGTH (P)  
 4 = 4.90 (0.46 PTH)  
 5 = 5.50 (0.46 PTH)  
 7 = 4.90 (0.39 PTH)  
 8 = 5.50 (0.39 PTH)

KEY ORIENTATION  
 0 = NO KEY  
 1 = A  
 2 = B  
 3 = C  
 4 = D  
 5 = E  
 6 = F  
 7 = G  
 8 = H

- NOTES:
1. MATERIALS: HOUSING - LIQUID CRYSTAL POLYMER (LCP), GLASS-FILLED, UL94V-0  
 TERMINALS - HIGH PERFORMANCE COPPER ALLOY
  2. FINISH: 30μN SELECTIVE GOLD IN CONTACT AREA, SELECTIVE TIN ON PCB TAILS, NICKEL OVERALL.
  3. REFER TO MOLEX PRODUCT SPECIFICATION PS-76060-999 FOR PERFORMANCE SPECIFICATIONS AND ADDITIONAL PCB INFORMATION.
  4. EACH SIGNAL WAFER CONTAINS 2 COLUMNS OF TERMINALS.
  5. PRODUCT IS PACKAGED PER PK-70873-777.
  6. THIS PART CONFORMS TO CLASS B REQUIREMENTS OF COSMETIC SPEC PS-45499-002.
  7. REFER TO MOLEX SALES DRAWING SD-76150-004 FOR THE MATING RECEPTACLES.
  8. REFER TO MOLEX PCB ROUTING GUIDE AS-76060-990 FOR ANTIPAD AND ROUTING RECOMMENDATIONS.
  9. WHEN USING A MOLEX SUPPLIED #2-32 SCREW 73726-0000 (9.50mm +/- 0.38 THREADABLE SCREW LENGTH) THE MAXIMUM BOARD THICKNESS IS 4.4MM.
  10. MARKING LOCATED APPROXIMATELY AS SHOWN, PART NUMBER AND DATE CODE.
  11. THESE DIMENSIONS REPRESENT THE AREA NEEDED TO ACCOMMODATE CONNECTOR INSERTION AND REPAIR ON THE PCB. THIS IS REFERRED TO AS THE 'CONNECTOR KEEP OUT ZONE' AND DOES NOT REPRESENT THE ACTUAL PERIMETER OF THE CONNECTOR.

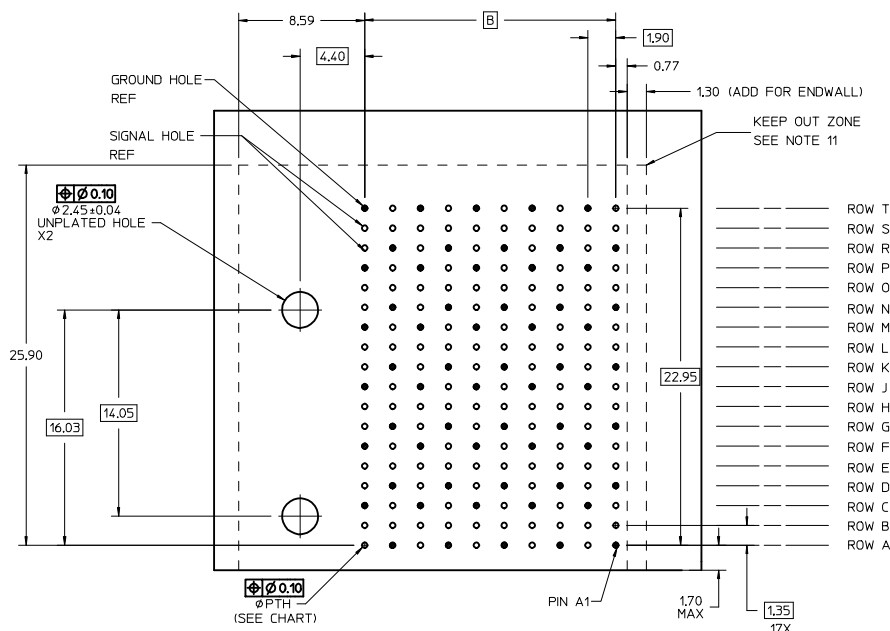

RAM HOLE PATTERN  
(CONNECTOR SIDE)

UPD PAGE 2 PCB VIEW IEC NO. UCP2017-1613 DRAWN: GONZALEZ01 2017/01/20 CHKD: APPR: TEL0 REV:	QUALITY SYMBOLS	GENERAL TOLERANCES (UNLESS SPECIFIED)	DIMENSION STYLE	SCALE	DESIGN UNITS	THIRD ANGLE PROJECTION
	▽=0	mm INCH	MM ONLY	4:1	METRIC	
	▽=0	4 PLACES ± --- ± ---	DRAWN BY DATE	TITLE		
	▽=0	3 PLACES ± --- ± ---	JGONZALEZ01 2015/06/25	IMPACT 6 PAIR RAM MARRIED GUIDE LEFT SALES DRAWING		
	2 PLACES ± 0.13 ± ---	CHECKED BY DATE	MATERIAL NO. DOCUMENT NO.			SHEET NO.
	1 PLACE ± 0.25 ± ---	APPROVED BY DATE	SEE TABLE			1 OF 2
	0 PLACE ± --- ± ---	TELO 2016/01/10	SD-76560-9002			
	ANGULAR ±1/2°	DRAFT WHERE APPLICABLE MUST REMAIN WITHIN DIMENSIONS	THIS DRAWING CONTAINS INFORMATION THAT IS PROPRIETARY TO MOLEX INCORPORATED AND SHOULD NOT BE USED WITHOUT WRITTEN PERMISSION			

20 19 18 17 16 15 14 13 12 11 10 9 8 7 6 5 4 3 2 1

COPLANAR APPLICATION

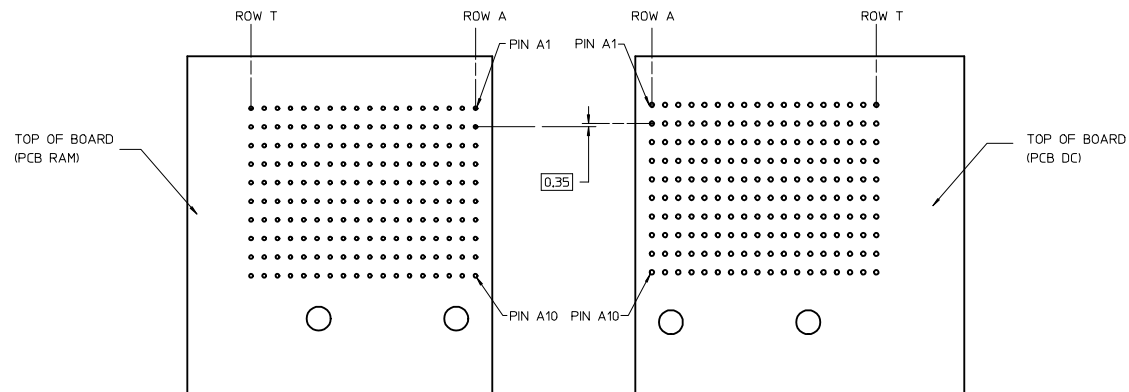
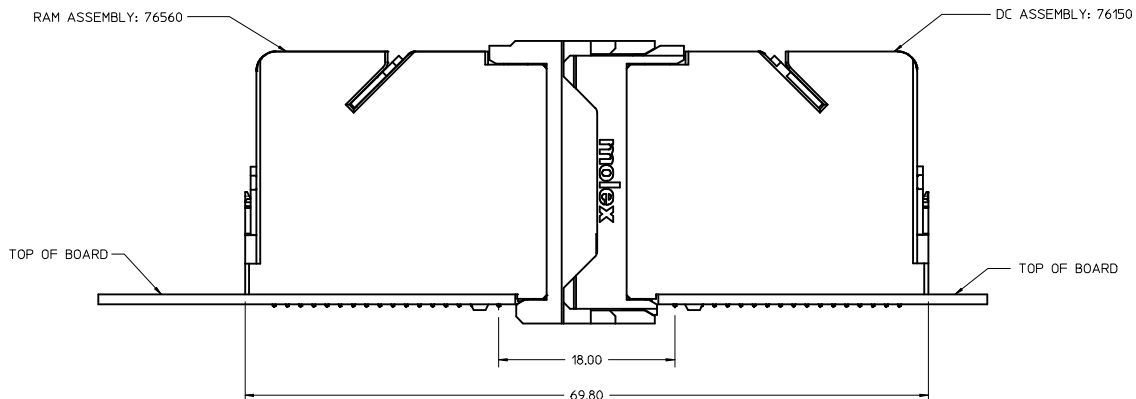

COPLANER MATED SIGNAL PATHS

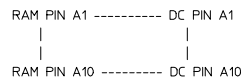

SEE SHEET 1 IEC NO. UCP2017-1613 DRAWN: GONZALEZ01 2017/01/20 CHKD: TELLO APPR: TELLO REV:	QUALITY SYMBOLS	GENERAL TOLERANCES (UNLESS SPECIFIED)	DIMENSION STYLE	SCALE	DESIGN UNITS	THIRD ANGLE PROJECTION
	▽=0	mm INCH	MM ONLY	4:1	METRIC	☉
	▽=0	4 PLACES ± --- ± ---	DRAWN BY	DATE	TITLE	IMPACT 6 PAIR RAM MARRIED GUIDE LEFT SALES DRAWING <b>molex</b>
	▽=0	3 PLACES ± --- ± ---	JGONZALEZ01	2015/06/25	2016/01/10	
▽=0	2 PLACES ± 0.13 ± ---	CHECKED BY	DATE	APPROVED BY	DATE	DOCUMENT NO.
	1 PLACE ± 0.25 ± ---	TELO	2016/01/10	TELO	2016/01/10	SD-76560-9002
	0 PLACE ± --- ± ---	ANGULAR ±1/2°	MATERIAL NO.	SEE CHART	SIZE	SHEET NO.
	DRAFT WHERE APPLICABLE MUST REMAIN WITHIN DIMENSIONS					2 OF 2
						THIS DRAWING CONTAINS INFORMATION THAT IS PROPRIETARY TO MOLEX INCORPORATED AND SHOULD NOT BE USED WITHOUT WRITTEN PERMISSION

19 18 17 16 15 14 13 12 11 10 9 8 7 6 5 4 3 2 1