

Overvoltage protected AC switch (ACS™)

Datasheet – production data

Features

- Needs no external protection snubber or varistor
- Enables equipment to meet IEC 61000-4-5
- Reduces component count by up to 80%
- Interfaces directly with the micro-controller
- Common package tab connection supports connection of several alternating current switches (ACS) on the same cooling pad
- Integrated structure based on A.S.D.® technology
- Overvoltage protection by crowbar technology
- High noise immunity - static $dV/dt > 500 \text{ V}/\mu\text{s}$

Applications

- Alternating current on/off static switching in appliances and industrial control systems
- Drive of low power high inductive or resistive loads like:
 - relay, valve, solenoid,
 - dispenser, door lock
 - pump, fan, low power motor

Description

The ACS108-6S belongs to the AC line switch family. This high performance switch can control a load of up to 0.8 A.

The ACS108-6S switch includes an overvoltage crowbar structure to absorb the overvoltage energy, and a gate level shifter driver to separate the digital controller from the main switch. It is triggered with a negative gate current flowing out of the gate pin.

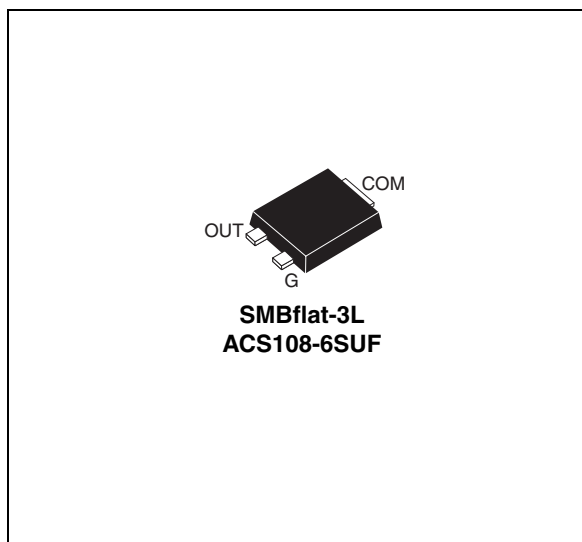

Figure 1. Functional diagram

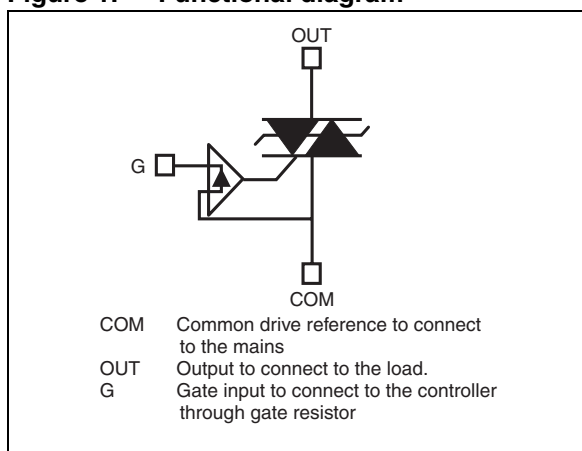

Table 1. Device summary

Symbol	Value	Unit
$I_{T(RMS)}$	0.8	A
V_{DRM}/V_{RRM}	600	V
I_{GT}	10	mA

®: A.S.D. is a registered trademark of STMicroelectronics

™: ACS is a trademark of STMicroelectronics

1 Characteristics

Table 2. Absolute maximum ratings ($T_{amb} = 25\text{ °C}$, unless otherwise specified)

Symbol	Parameter		Value	Unit	
$I_{T(RMS)}$	On-state rms current (full sine wave)		$T_{amb} = 62\text{ °C}$	0.45	A
			$T_{tab} = 113\text{ °C}$	0.8	A
I_{TSM}	Non repetitive surge peak on-state current (full cycle sine wave, T_j initial = 25 °C)	$F = 60\text{ Hz}$	$t = 16.7\text{ ms}$	7.6	A
		$F = 50\text{ Hz}$	$t = 20\text{ ms}$	7.3	
I^2t	I^2t Value for fusing		$t_p = 10\text{ ms}$	0.38	A^2s
di/dt	Critical rate of rise of on-state current $I_G = 2 \times I_{GT}$; $t_r \leq 100\text{ ns}$	$F = 120\text{ Hz}$	$T_j = 125\text{ °C}$	100	$A/\mu s$
V_{PP}	Non repetitive line peak mains voltage ⁽¹⁾		$T_j = 25\text{ °C}$	2	kV
I_{GM}	Peak gate current	$t_p = 20\text{ }\mu s$	$T_j = 125\text{ °C}$	1	A
V_{GM}	Peak positive gate voltage		$T_j = 125\text{ °C}$	10	V
$P_{G(AV)}$	Average gate power dissipation		$T_j = 125\text{ °C}$	0.1	W
T_{stg}	Storage junction temperature range			-40 to +150	$^{\circ}C$
T_j	Operating junction temperature range			-30 to +125	

1. according to test described by IEC 61000-4-5 standard and [Figure 19](#)

Table 3. Electrical characteristics ($T_j = 25\text{ °C}$, unless otherwise specified)

Symbol	Test conditions	Quadrant		Value	Unit
$I_{GT}^{(1)}$	$V_{OUT} = 12\text{ V}$, $R_L = 33\text{ }\Omega$	II - III	Max.	10	mA
V_{GT}				1	V
V_{GD}	$V_{OUT} = V_{DRM}$, $R_L = 3.3\text{ k}\Omega$, $T_j = 125\text{ °C}$	II - III	Min.	0.15	V
$I_H^{(2)}$	$I_{OUT} = 100\text{ mA}$		Max.	25	mA
$I_L^{(2)}$	$I_G = 1.2 \times I_{GT}$		Max.	30	mA
$dV/dt^{(2)}$	$V_{OUT} = 67\% V_{DRM}$, gate open, $T_j = 125\text{ °C}$		Min.	500	$V/\mu s$
$(di/dt)_c^{(2)}$	Without snubber ($15\text{ V}/\mu s$), turn-off time $\leq 20\text{ ms}$, $T_j = 125\text{ °C}$		Min.	0.3	A/ms
V_{CL}	$I_{CL} = 0.1\text{ mA}$, $t_p = 1\text{ ms}$, $T_j = 125\text{ °C}$		Min.	650	V

1. Minimum I_{GT} is guaranteed at 10% of I_{GT} max
2. For both polarities of OUT referenced to COM

Table 4. Static electrical characteristics

Symbol	Test conditions			Value	Unit
$V_{TM}^{(1)}$	$I_{TM} = 1.1 \text{ A}$, $t_p = 500 \mu\text{s}$	$T_j = 25 \text{ }^\circ\text{C}$	Max.	1.3	V
$V_{TO}^{(1)}$	Threshold voltage	$T_j = 125 \text{ }^\circ\text{C}$	Max.	0.90	V
$R_D^{(1)}$		$T_j = 125 \text{ }^\circ\text{C}$	Max.	300	m Ω
I_{DRM} I_{RRM}	$V_{OUT} = 600 \text{ V}$	$T_j = 25 \text{ }^\circ\text{C}$	Max.	2	μA
		$T_j = 125 \text{ }^\circ\text{C}$		0.2	mA

1. For both polarities of OUT referenced to COM

Table 5. Thermal resistance

Symbol	Parameter			Value	Unit
$R_{th(j-t)}$	Junction to tab (AC)		Max.	14	$^\circ\text{C/W}$
$R_{th(j-a)}$	Junction to ambient	$S = 5 \text{ cm}^2$	Max.	75	

Figure 2. Maximum power dissipation versus on-state rms current (full cycle)

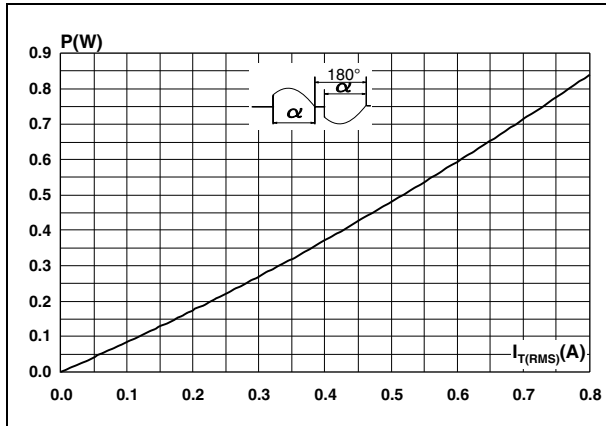

Figure 3. On-state rms current versus tab temperature (full cycle)

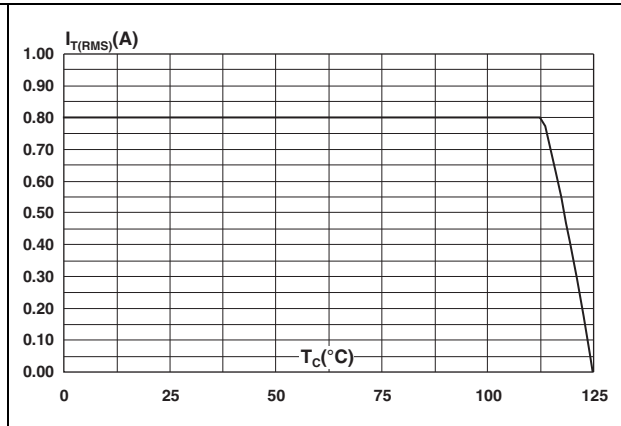

Figure 4. On-state rms current versus ambient temperature (free air convection)

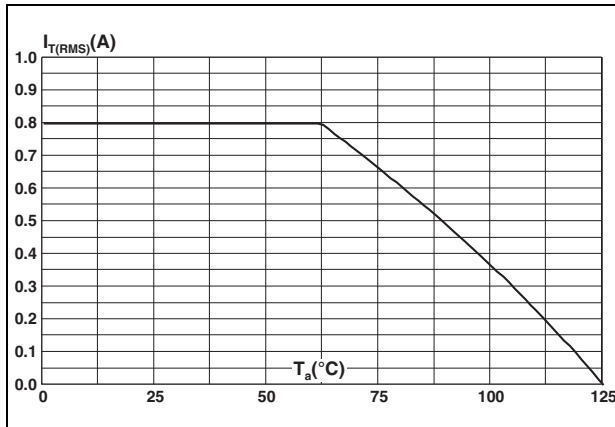

Figure 5. Relative variation of thermal impedance junction to ambient versus pulse duration

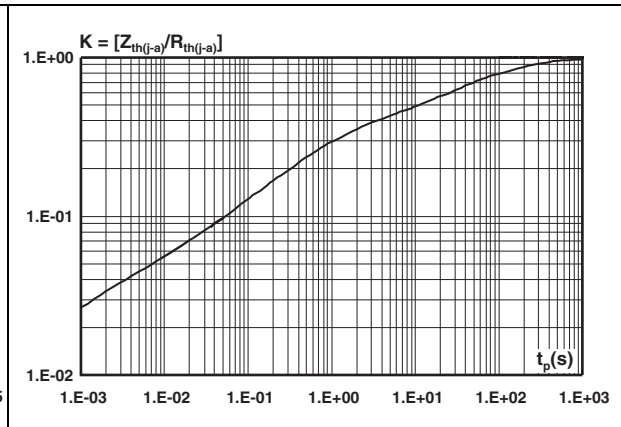

Figure 6. Relative variation of, holding and latching current versus junction temperature

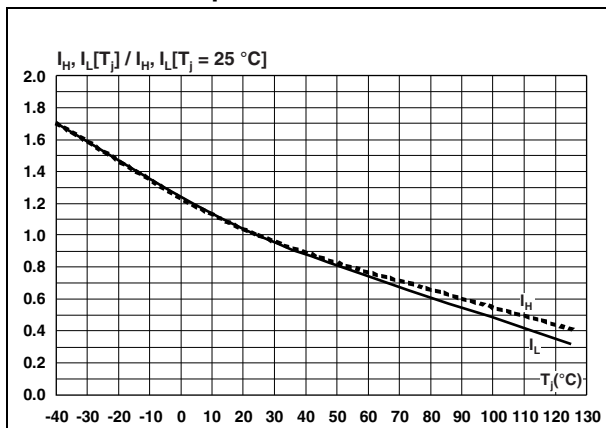

Figure 7. Relative variation of I_{GT} and V_{GT} versus junction temperature

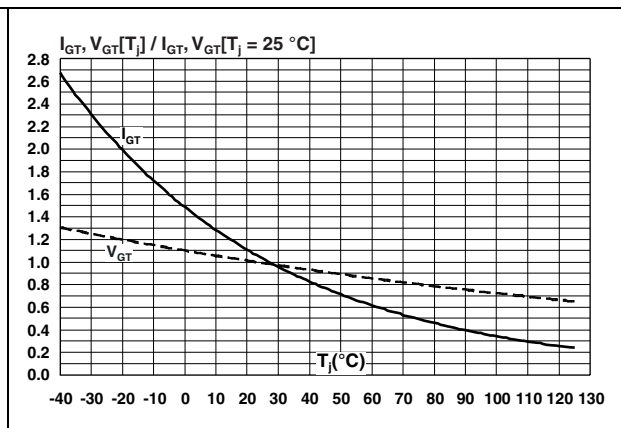

Figure 8. Non repetitive surge peak on-state current versus number of cycles

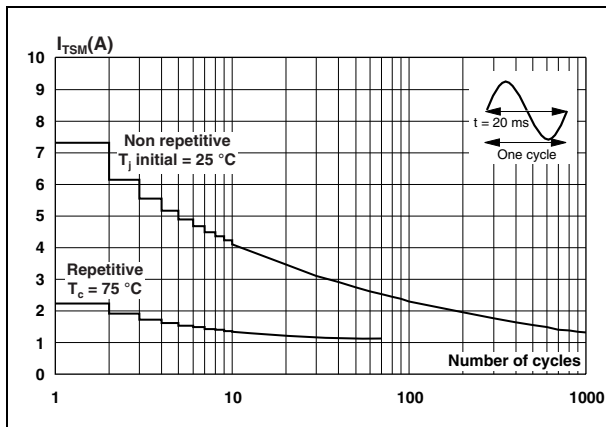

Figure 9. Non repetitive surge peak on-state current for a sinusoidal pulse, and corresponding value of I²t

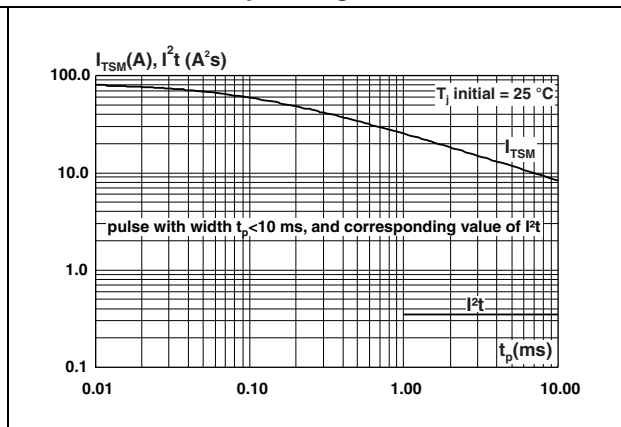

Figure 10. On-state characteristics (maximal values)

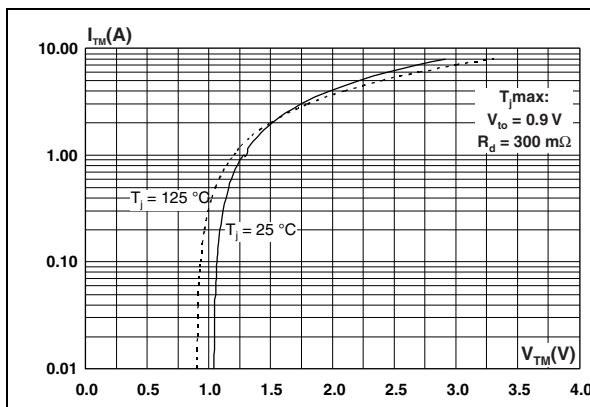

Figure 11. Relative variation of critical rate of decrease of main current versus junction temperature

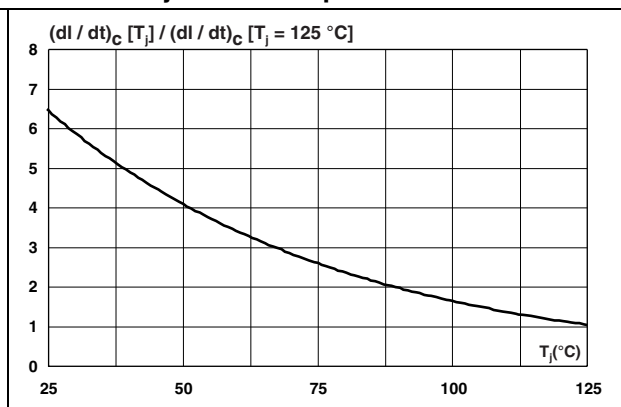

Figure 12. Relative variation of static dV/dt immunity versus junction temperature

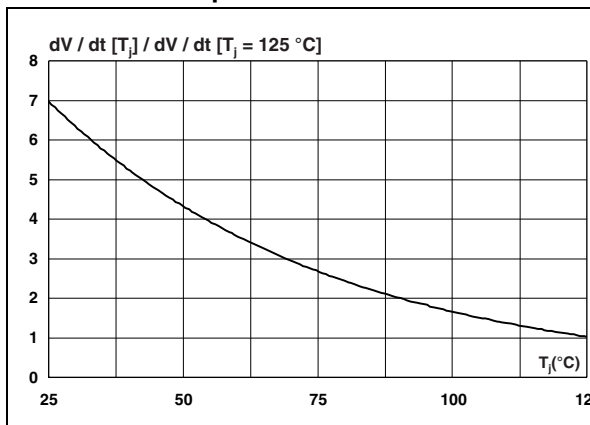

Figure 13. Relative variation of the maximal clamping voltage versus junction temperature (min. value)

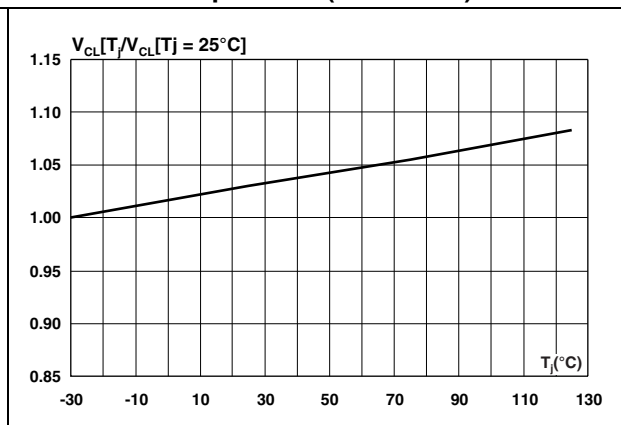

Figure 14. Relative variation of critical rate of decrease of main current (di/dt)_c versus (dV/dt)_c

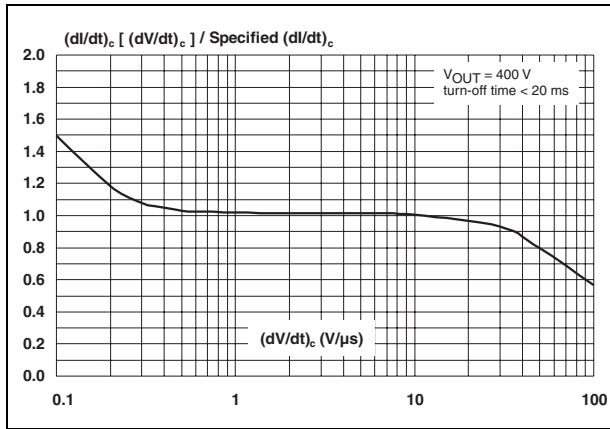
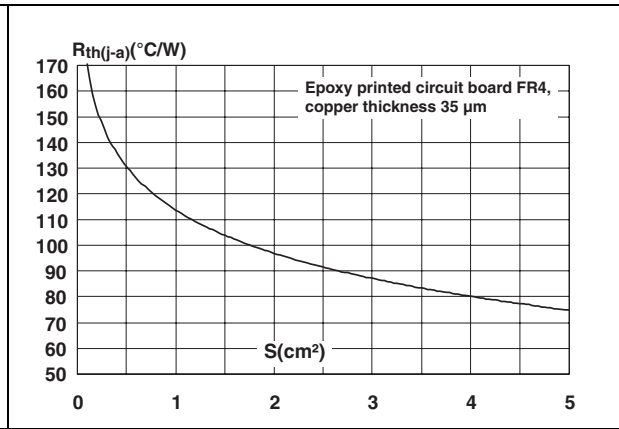

Figure 15. Thermal resistance junction to ambient versus copper surface under tab



2 Alternating current line switch - basic application

The ACS108-6S switch is triggered by a negative gate current flowing from the gate pin G. The switch can be driven directly by the digital controller through a resistor as shown in [Figure 16](#).

Thanks to its overvoltage protection and turn-off commutation performance, the ACS108-6S switch can drive a small power high inductive load with neither varistor nor additional turn-off snubber.

Figure 16. Typical application program

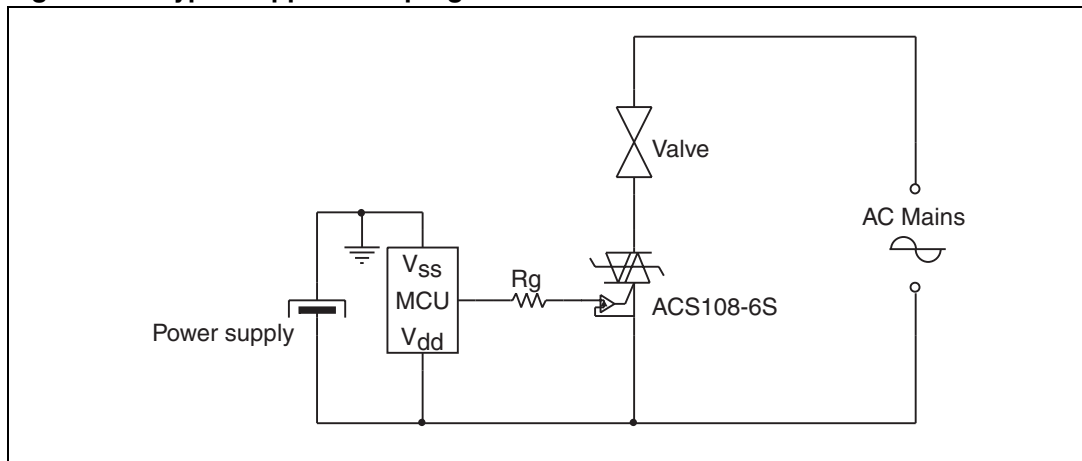

2.1 Protection against overvoltage: the best choice is ACS

In comparison with standard triacs, which are not robust against surge voltage, the ACS108-6S is over-voltage self-protected, specified by the new parameter V_{CL} . This feature is useful in two operating conditions: in case of turn-off of very inductive load, and in case of surge voltage that can occur on the electrical network.

2.1.1 High inductive load switch-off: turn-off overvoltage clamping

With high inductive and low RMS current loads the rate of decrease of the current is very low. An overvoltage can occur when the gate current is removed and the OUT current is lower than I_H .

As shown in [Figure 17](#) and [Figure 18](#), at the end of the last conduction half-cycle, the load current decreases (1). The load current reaches the holding current level I_H (2), and the ACS turns off (3). The water valve, as an inductive load (up to 15 H), reacts as a current generator and an overvoltage is created, which is clamped by the ACS (4). The current flows through the ACS avalanche and decreases linearly to zero. During this time, the voltage across the switch is limited to the clamping voltage V_{CL} . The energy stored in the inductance of the load is dissipated in the clamping section that is designed for this purpose. When the energy has been dissipated, the ACS voltage falls back to the mains voltage value (5).

Figure 17. Effect of the switching off of a high inductive load - typical clamping capability of ACS108-6S

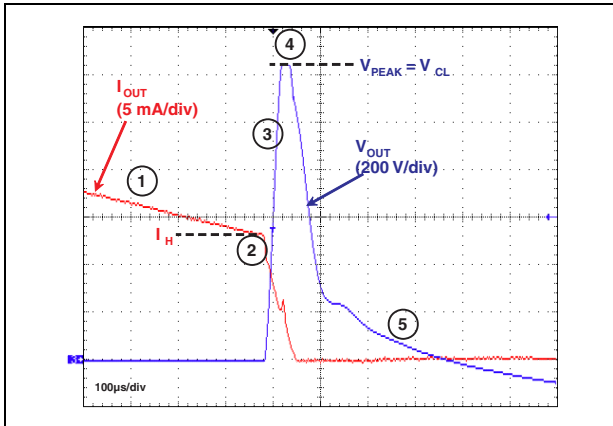
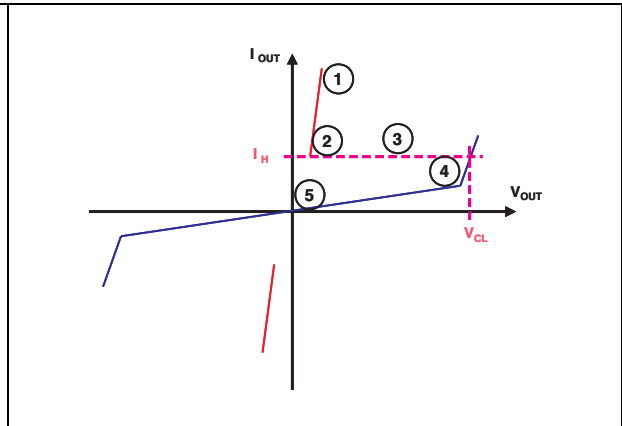

Figure 18. Description of the different steps during switching off of a high inductive load



2.1.2 Alternating current line transient voltage ruggedness

The ACS108-6S switch is able to withstand safely the ac line transients either by clamping the low energy spikes or by breaking over under high energy shocks, even with high turn-on current rises.

The test circuit shown in *Figure 19* is representative of the final ACS108-6S application, and is also used to test the ac switch according to the IEC 61000-4-5 standard conditions. Thanks to the load limiting the current, the ACS108-6S switch withstands the voltage spikes up to 2 kV above the peak line voltage. The protection is based on an overvoltage crowbar technology. Actually, the ACS108-6S breaks over safely as shown in *Figure 20*. The ACS108-6S recovers its blocking voltage capability after the surge (switch off back at the next zero crossing of the current).

Such non-repetitive tests can be done 10 times on each ac line voltage polarity.

Figure 19. Overvoltage ruggedness test circuit for resistive and inductive

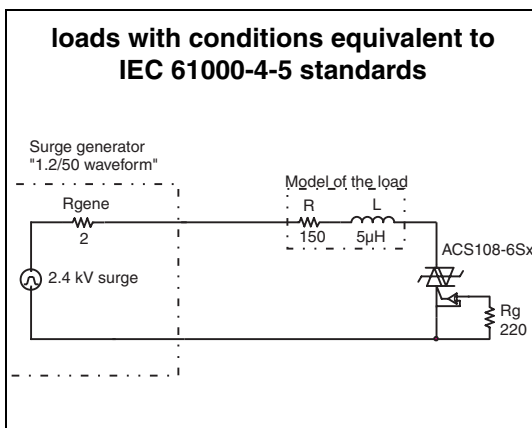
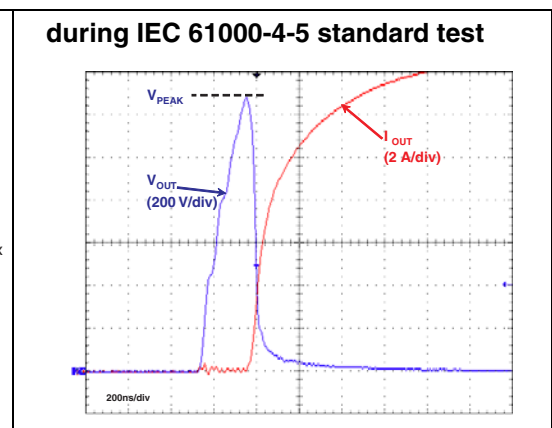
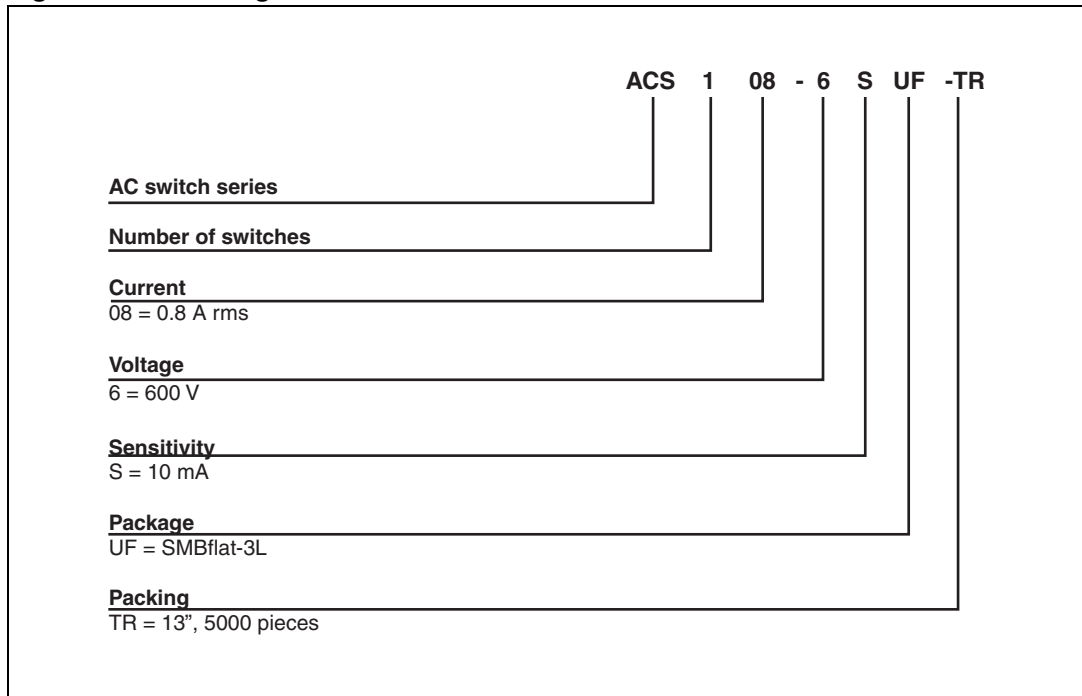

Figure 20. Typical current and voltage waveforms across the ACS108-6S during IEC 61000-4-5 standard test



3 Ordering information scheme

Figure 21. Ordering information scheme



4 Package information

- Epoxy meets UL94, V0
- Lead-free packages

In order to meet environmental requirements, ST offers these devices in different grades of ECOPACK® packages, depending on their level of environmental compliance. ECOPACK® specifications, grade definitions and product status are available at: www.st.com. ECOPACK® is an ST trademark.

Table 6. SMBflat-3L dimensions

Ref.	Dimensions					
	Millimeters			Inches		
	Min.	Typ.	Max.	Min.	Typ.	Max.
A	0.90		1.10	0.035		0.043
b	0.35		0.65	0.014		0.026
b4	1.95		2.20	0.07		0.087
c	0.15		0.40	0.006		0.016
D	3.30		3.95	0.130		0.156
E	5.10		5.60	0.201		0.220
E1	4.05		4.60	0.156		0.181
L	0.75		1.50	0.030		0.059
L1		0.40			0.016	
L2		0.60			0.024	
e		1.60			0.063	

Figure 22. SMBflat-3L footprint dimensions

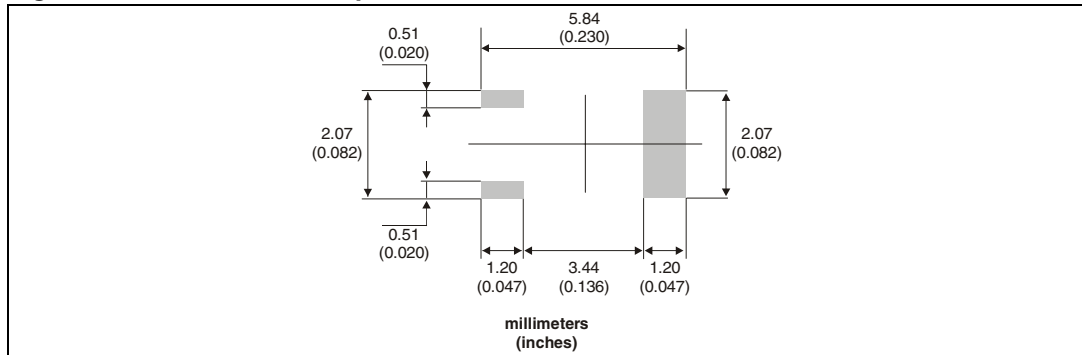

5 Ordering information

Table 7. Ordering information

Order code	Marking	Package	Weight	Base Qty	Delivery mode
ACS108-6SUF-TR	ACS1086S	SMBflat-3L	46.91 mg	5000	Tape and reel

6 Revision history

Table 8. Document revision history

Date	Revision	Changes
05-Jan-2005	1	Initial release.
07-Jun-2006	2	Reformatted to current standard. Replaced Figure 9.
14-Dec-2010	3	Added Epoxy meets UL94, V0 in Package information . Updated ECOPACK statement. Added SMBflat-3L package. Updated graphics.
12-Jun-2012	4	Information regarding TO-92 and SOT-223 packages transferred to STMicroelectronics datasheet ACS108.

Please Read Carefully:

Information in this document is provided solely in connection with ST products. STMicroelectronics NV and its subsidiaries ("ST") reserve the right to make changes, corrections, modifications or improvements, to this document, and the products and services described herein at any time, without notice.

All ST products are sold pursuant to ST's terms and conditions of sale.

Purchasers are solely responsible for the choice, selection and use of the ST products and services described herein, and ST assumes no liability whatsoever relating to the choice, selection or use of the ST products and services described herein.

No license, express or implied, by estoppel or otherwise, to any intellectual property rights is granted under this document. If any part of this document refers to any third party products or services it shall not be deemed a license grant by ST for the use of such third party products or services, or any intellectual property contained therein or considered as a warranty covering the use in any manner whatsoever of such third party products or services or any intellectual property contained therein.

UNLESS OTHERWISE SET FORTH IN ST'S TERMS AND CONDITIONS OF SALE ST DISCLAIMS ANY EXPRESS OR IMPLIED WARRANTY WITH RESPECT TO THE USE AND/OR SALE OF ST PRODUCTS INCLUDING WITHOUT LIMITATION IMPLIED WARRANTIES OF MERCHANTABILITY, FITNESS FOR A PARTICULAR PURPOSE (AND THEIR EQUIVALENTS UNDER THE LAWS OF ANY JURISDICTION), OR INFRINGEMENT OF ANY PATENT, COPYRIGHT OR OTHER INTELLECTUAL PROPERTY RIGHT.

UNLESS EXPRESSLY APPROVED IN WRITING BY TWO AUTHORIZED ST REPRESENTATIVES, ST PRODUCTS ARE NOT RECOMMENDED, AUTHORIZED OR WARRANTED FOR USE IN MILITARY, AIR CRAFT, SPACE, LIFE SAVING, OR LIFE SUSTAINING APPLICATIONS, NOR IN PRODUCTS OR SYSTEMS WHERE FAILURE OR MALFUNCTION MAY RESULT IN PERSONAL INJURY, DEATH, OR SEVERE PROPERTY OR ENVIRONMENTAL DAMAGE. ST PRODUCTS WHICH ARE NOT SPECIFIED AS "AUTOMOTIVE GRADE" MAY ONLY BE USED IN AUTOMOTIVE APPLICATIONS AT USER'S OWN RISK.

Resale of ST products with provisions different from the statements and/or technical features set forth in this document shall immediately void any warranty granted by ST for the ST product or service described herein and shall not create or extend in any manner whatsoever, any liability of ST.

ST and the ST logo are trademarks or registered trademarks of ST in various countries.

Information in this document supersedes and replaces all information previously supplied.

The ST logo is a registered trademark of STMicroelectronics. All other names are the property of their respective owners.

© 2012 STMicroelectronics - All rights reserved

STMicroelectronics group of companies

Australia - Belgium - Brazil - Canada - China - Czech Republic - Finland - France - Germany - Hong Kong - India - Israel - Italy - Japan - Malaysia - Malta - Morocco - Philippines - Singapore - Spain - Sweden - Switzerland - United Kingdom - United States of America

www.st.com