

TPS63900 1.8-V to 5.5-V, 75-nA I_Q Buck-boost Converter with Input Current Limit and DVS

1 Features

- Input voltage range: 1.8 V to 5.5 V
- Output voltage range: 1.8 V to 5 V (100-mV steps)
 - Programmable with external resistors
 - SEL pin to toggle between two output voltage presets
- > 400-mA output current for $V_I \geq 2.0$ V, $V_O = 3.3$ V (typical 1.45-A peak switching current limit)
 - Stackable: parallel multiple devices for higher output current
- > 90% Efficiency at 10- μ A load current
 - 75-nA quiescent current
 - 60-nA shutdown current
- Single-mode operation
 - Eliminates mode transitions between buck, buck-boost and boost operation
 - Low output ripple
 - Excellent transient performance
- Safety and robust operation features
 - Integrated soft start
 - Programmable input current limit with eight settings (1 mA to 100 mA and unlimited)
 - Output short-circuit and overtemperature protection
- Tiny solution size of 21-mm²
 - Small 2.2- μ H inductor, single 22- μ F output capacitor
 - 10-Pin, 2.5-mm \times 2.5-mm, 0.5-mm pitch WSON package

2 Applications

- [Smart meters and sensor nodes](#)
- [Electronic smart locks](#)
- [Medical sensor patches](#) and [patient monitors](#)
- [Wearable electronics](#)
- [Asset tracking](#)
- [Industrial IoT \(smart sensors\) / NB-IoT](#)

3 Description

The TPS63900 device is a high-efficiency synchronous buck-boost converter with an extremely low quiescent current (75 nA typical). The device has 32 user-programmable output voltage settings from 1.8 V to 5 V.

A dynamic voltage-scaling feature lets applications switch between two output voltages during operation; for example, to save power by using a lower system supply voltage during standby operation.

With its wide supply voltage range and programmable input current limit (1 mA to 100 mA and unlimited), the device is ideal for use with a wide range of primary like 3S Alkaline, 1S Li-MnO₂ or 1S Li-SOCl₂, and secondary battery types.

The high-output current capability supports commonly-used RF standards like sub-1-GHz, BLE, LoRa, wM-Bus, and NB-IoT.

Device Information

PART NUMBER ⁽¹⁾	PACKAGE	BODY SIZE (NOM)
TPS63900	WSON (10)	2.5 mm \times 2.5 mm

(1) For all available packages, see the orderable addendum at the end of the data sheet.

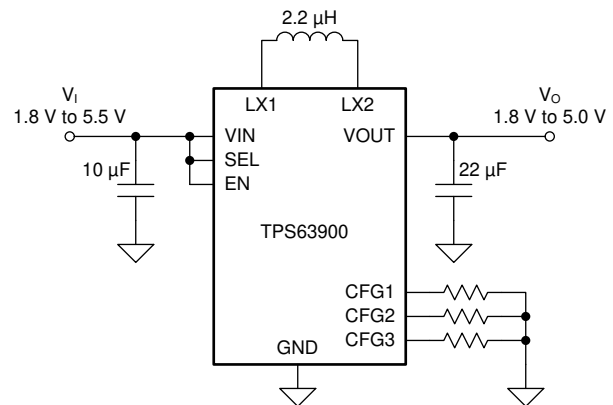

Simplified Schematic



Table of Contents

1 Features	1	8 Application and Implementation	18
2 Applications	1	8.1 Application Information.....	18
3 Description	1	8.2 Typical Application.....	18
4 Revision History	2	9 Power Supply Recommendations	30
5 Pin Configuration and Functions	3	10 Layout	31
6 Specifications	4	10.1 Layout Guidelines.....	31
6.1 Absolute Maximum Ratings	4	10.2 Layout Example.....	31
6.2 ESD Ratings	4	11 Device and Documentation Support	32
6.3 Recommended Operating Conditions	4	11.1 Device Support.....	32
6.4 Thermal Information	4	11.2 Documentation Support.....	32
6.5 Electrical Characteristics	5	11.3 Receiving Notification of Documentation Updates..	32
6.6 Typical Characteristics.....	7	11.4 Support Resources.....	32
7 Detailed Description	8	11.5 Trademarks.....	32
7.1 Overview.....	8	11.6 Electrostatic Discharge Caution.....	32
7.2 Functional Block Diagram.....	8	11.7 Glossary.....	32
7.3 Feature Description.....	8	12 Mechanical, Packaging, and Orderable	
7.4 Device Functional Modes.....	17	Information	32

4 Revision History

NOTE: Page numbers for previous revisions may differ from page numbers in the current version.

Changes from Revision C (September 2020) to Revision D (October 2020)	Page
• Changed device status from Advance Information to Production Data.....	1

5 Pin Configuration and Functions

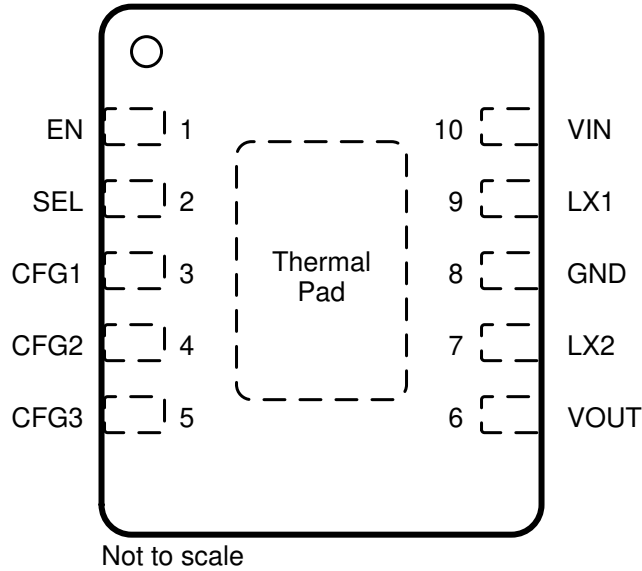

Figure 5-1. 10-Pin WSON DSK Package (Top View)

Table 5-1. Pin Functions

PIN		I/O	DESCRIPTION
NO.	NAME		
1	EN	I	Device enable. A high level applied to this pin enables the device and a low level disables it. It must not be left open.
2	SEL	I	Output voltage select. Selects $V_{O(2)}$ when a high level is applied to this pin. Selects $V_{O(1)}$ when a low level is applied to this pin. It must not be left open.
3	CFG1	I	Configuration pin 1. Connect a resistor between this pin and ground to set $V_{O(2)}$ and input current limit, must not be left open.
4	CFG2	I	Configuration pin 2. Connect a resistor between this pin and ground to set $V_{O(2)}$ and input current limit. Must not be left open.
5	CFG3	I	Configuration pin 3. Connect a resistor between this pin and ground to set $V_{O(1)}$. Must not be left open.
6	VOUT	—	Output voltage
7	LX2	—	Switching node of the boost stage
8	GND	—	Ground
9	LX1	—	Switching node of the buck stage
10	VIN	—	Supply voltage
—	Thermal Pad	—	Connect this pin to ground for correct operation.

6 Specifications

6.1 Absolute Maximum Ratings

over operating junction temperature range (unless otherwise noted)⁽¹⁾

		MIN	MAX	UNIT
V_I	Input voltage (V_{IN} , LX1, LX2, VOUT, EN, CFG1, CFG2, CFG3, SEL) ⁽²⁾	-0.3	5.9	V
T_J	Operating junction temperature	-40	150	°C
T_{stg}	Storage temperature	-65	150	°C

- (1) Stresses beyond those listed under *Absolute Maximum Ratings* may cause permanent damage to the device. These are stress ratings only, which do not imply functional operation of the device at these or any other conditions beyond those indicated under *Recommended Operating Conditions*. Exposure to absolute-maximum-rated conditions for extended periods may affect device reliability.
- (2) All voltage values are with respect to network ground terminal, unless otherwise noted.

6.2 ESD Ratings

			VALUE	UNIT
$V_{(ESD)}$	Electrostatic discharge	Human body model (HBM), per ANSI/ESDA/JEDEC JS-001 ⁽¹⁾	±2000	V
		Charged-device model (CDM), per JEDEC specification JESD22-C101 or ANSI/ESDA/JEDEC JS-002 ⁽²⁾	±750	

- (1) JEDEC document JEP155 states that 500-V HBM allows safe manufacturing with a standard ESD control process.
- (2) JEDEC document JEP157 states that 250-V CDM allows safe manufacturing with a standard ESD control process.

6.3 Recommended Operating Conditions

over operating free-air temperature range (unless otherwise noted)

		MIN	NOM	MAX	UNIT
V_I	Supply voltage	1.8		5.5	V
V_O	Output voltage	1.8		5.0	V
I_O	Output current ($V_I \geq 2.0$ V, $V_O = 3.6$ V)			0.4	A
C_I	Input capacitance ($V_I = 2.5$ V to 5 V, $V_O = 3.3$ V, $I_O = 0.4$ A) ⁽¹⁾	5			µF
C_O	Output capacitance ($V_I = 2.5$ V to 5 V, $V_O = 3.3$ V, $I_O = 0.4$ A) ⁽¹⁾	10			µF
$C_{(CFG)}$	Capacitance (CFG1, CFG2, CFG3)			10	pF
L	Inductance		2.2		µH
I_{SAT}	Inductor saturation current rating	Unlimited current setting	2		A
		≤100-mA current settings	1		
T_A	Operating ambient temperature	-40		85	°C
T_J	Operating junction temperature	-40		125	°C

- (1) Effective capacitance after DC bias effects have been considered.

6.4 Thermal Information

THERMAL METRIC ⁽¹⁾		TPS63900	UNIT
		DSK Package (WSON)	
		10 PINS	
$R_{\theta JA}$	Junction-to-ambient thermal resistance	64.6	°C/W
$R_{\theta JC(top)}$	Junction-to-case (top) thermal resistance	62.3	°C/W
$R_{\theta JB}$	Junction-to-board thermal resistance	31.1	°C/W
Ψ_{JT}	Junction-to-top characterization parameter	1.6	°C/W

THERMAL METRIC ⁽¹⁾		TPS63900	UNIT
		DSK Package (WSON)	
		10 PINS	
Ψ_{JB}	Junction-to-board characterization parameter	31.0	°C/W
$R_{\theta JC(bot)}$	Junction-to-case (bottom) thermal resistance	10.0	°C/W

(1) For more information about traditional and new thermal metrics, see the *Semiconductor and IC Package Thermal Metrics* application report, [SPRA953](#).

6.5 Electrical Characteristics

Over operating junction temperature range and recommended supply voltage range (unless otherwise noted). Typical values are at $V_I = 3.0\text{ V}$, $V_O = 2.5\text{ V}$ and $T_J = 25^\circ\text{C}$ (unless otherwise noted).

PARAMETER		TEST CONDITIONS	MIN	TYP	MAX	UNIT
SUPPLY						
	Quiescent current into VIN	$V_{(EN)} = 3\text{ V}$, no load, not switching, "unlimited" current setting		0.075	1	μA
	Shutdown current into VIN	$V_{(EN)} = 0\text{ V}$		60		nA
$V_{IT+(UVLO)}$	Positive-going UVLO threshold voltage		1.73	1.75	1.77	V
$V_{hys(UVLO)}$	UVLO threshold voltage hysteresis		90	100	110	mV
$V_{IT+(POR)}$	Positive-going POR threshold voltage		1.37		1.74	V
I/O SIGNALS						
V_{IH}	High-level input voltage (EN, SEL)				1.2	V
V_{IL}	Low-level input voltage (EN, SEL)		0.4			V
	Input current (EN, SEL)	$V_{(EN)}, V_{(SEL)} = 1.8\text{ V}$ or 0 V . $T_J = 25^\circ\text{C}$		± 1	± 10	nA
POWER SWITCH						
$r_{DS(on)}$	On-state resistance	Q1	$V_I = 3\text{ V}$, $V_O = 5\text{ V}$, test current = 1 A		155	m Ω
		Q2	$V_I = 3\text{ V}$, $V_O = 3\text{ V}$, test current = 1 A		110	
		Q3	$V_I = 3\text{ V}$, $V_O = 3\text{ V}$, test current = 1 A		110	
		Q4	$V_I = 5\text{ V}$, $V_O = 3\text{ V}$, test current = 1 A		155	
CURRENT LIMIT						
	Peak current limit during Startup (Q1)	$V_I = 3.6\text{ V}$, unlimited current limit setting	0.35		0.83	A
	Peak current limit (Q1)	$V_I = 1.8\text{ V}$, $V_O = 3.6\text{ V}$, unlimited current limit setting	1.33	1.45	1.6	A
		$V_I = 3.6\text{ V}$, $V_O = 3.3\text{ V}$, 100-mA current limit setting	0.15	0.29	0.51	
	Average input current limit	$T_J = -40^\circ\text{C}$ to 85°C	1-mA setting		1	mA
			2.5-mA setting		2.5	
			5-mA setting		5	
			10-mA setting		10	
			25-mA setting		25	
			50-mA setting		50	
			100-mA setting		100	
OUTPUT						
	Output voltage DC accuracy	$I_O = 1\text{ mA}$, $C_{O(eff)} = 10\text{ }\mu\text{F}$, $L_{(eff)} = 2.2\text{ }\mu\text{H}$			± 1.5	%

Over operating junction temperature range and recommended supply voltage range (unless otherwise noted). Typical values are at $V_I = 3.0\text{ V}$, $V_O = 2.5\text{ V}$ and $T_J = 25^\circ\text{C}$ (unless otherwise noted).

PARAMETER		TEST CONDITIONS	MIN	TYP	MAX	UNIT
CONTROL						
	Internal reference resistor			33		k Ω
R _{CFG}	R2D setting #0			0	0.1	k Ω
	R2D setting #1		-3%	0.511	+3%	
	R2D setting #2		-3%	1.15	+3%	
	R2D setting #3		-3%	1.87	+3%	
	R2D setting #4		-3%	2.74	+3%	
	R2D setting #5		-3%	3.83	+3%	
	R2D setting #6		-3%	5.11	+3%	
	R2D setting #7		-3%	6.49	+3%	
	R2D setting #8		-3%	8.25	+3%	
	R2D setting #9		-3%	10.5	+3%	
	R2D setting #10		-3%	13.3	+3%	
	R2D setting #11		-3%	16.2	+3%	
	R2D setting #12		-3%	20.5	+3%	
	R2D setting #13		-3%	24.9	+3%	
	R2D setting #14		-3%	30.1	+3%	
	R2D setting #15		-3%	36.5	+3%	
PROTECTION FEATURES						
	Thermal shutdown threshold temperature		140	150	160	$^\circ\text{C}$
	Thermal shutdown hysteresis		15	20	25	$^\circ\text{C}$
TIMING PARAMETERS						
t _{d(POR)}	POR signal delay after reaching POR threshold			3.8		ms
t _{d(EN)}	Delay between a rising edge on the EN pin and the start of the output voltage ramp	Supply voltage stable before EN pin goes high			1.5	ms
t _{w(SS)}	Soft-start step duration	V _O > 1.8 V	100	125	150	μs
t _{d(SEL)}	Delay between a change in the state of the SEL pin and the first step change in the output voltage			30	40	μs
t _{w(DVS)}	Dynamic voltage scaling step duration		100	125	150	μs
t _{d(RESTART)}	Restart delay after protection			10	11	ms

6.6 Typical Characteristics

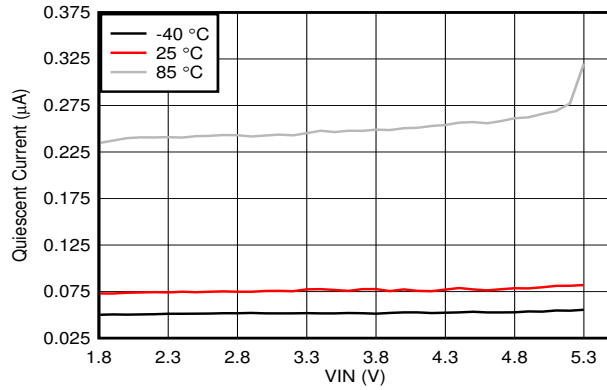

$V_O = 5.1\text{ V}$ $EN = \text{HIGH}$ $I_O = 0\text{ mA}$, device
 not switching

Figure 6-1. Quiescent Current into VIN versus Input Voltage

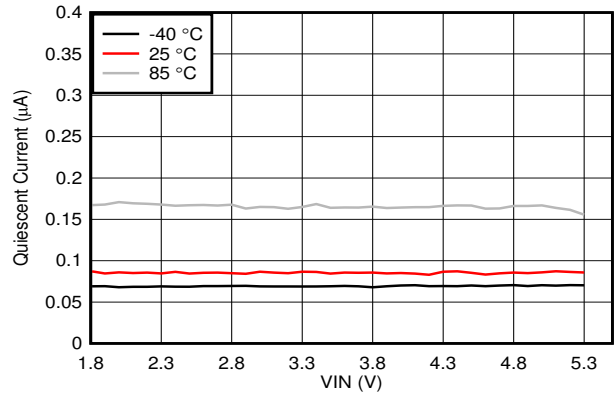

$V_O = 5.1\text{ V}$ $EN = \text{HIGH}$ $I_O = 0\text{ mA}$, device
 not switching

Figure 6-2. Quiescent Current into VOUT versus Input Voltage

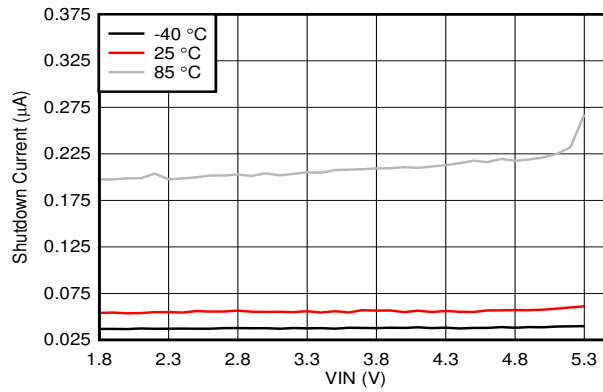

$V_O = 5.1\text{ V}$

$EN = \text{LOW}$

Figure 6-3. Shutdown Current versus Input Voltage

7 Detailed Description

7.1 Overview

The TPS63900 device is a four-switch synchronous buck-boost converter with a maximum output current of 400 mA. It has a single-mode operation that allows the device to regulate the output voltage to a level above, below, or equal to the input voltage without displaying the mode-switching transients and unpredictable inductor current ripple from which many other buck-boost devices suffer.

The switching frequency of the TPS63900 device varies with the operating conditions: it is lowest when I_O is low and increases smoothly as I_O increases.

7.2 Functional Block Diagram

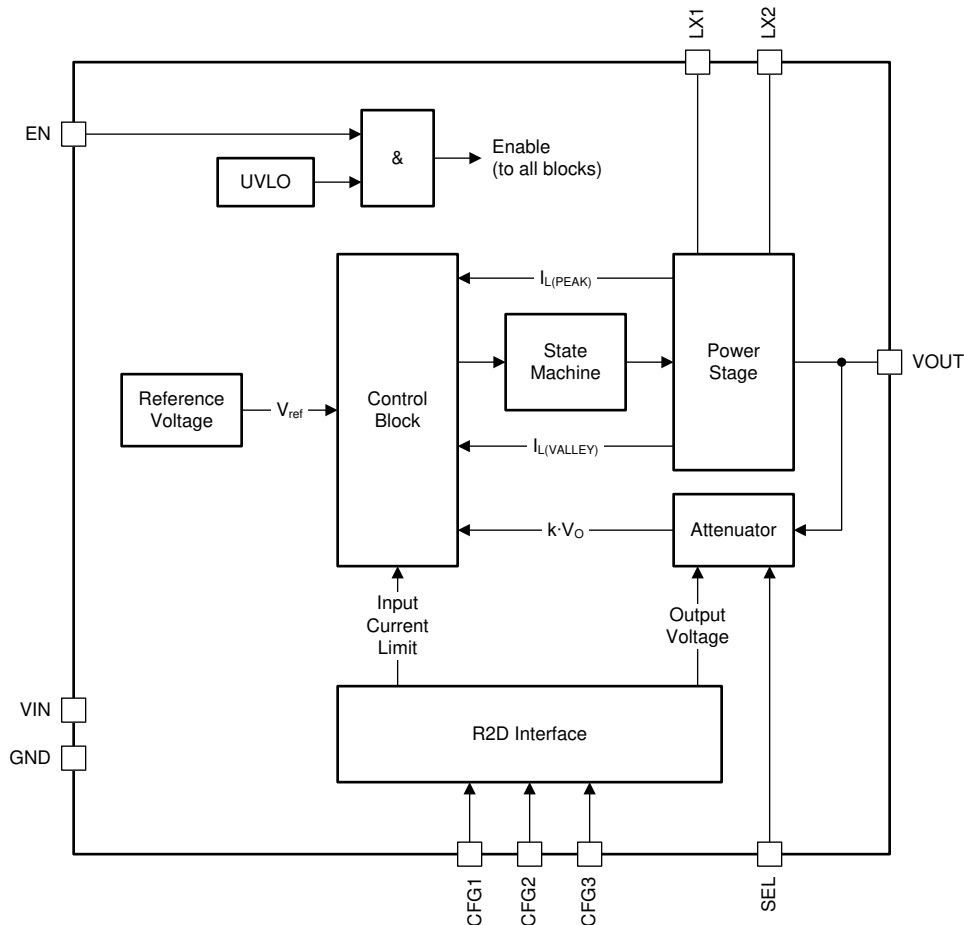

7.3 Feature Description

7.3.1 Trapezoidal Current Control

Figure 7-1 shows a simplified block diagram of the power stage of the device. Inductor current is sensed in series with Q1 (the peak current) and Q4 (the valley current).

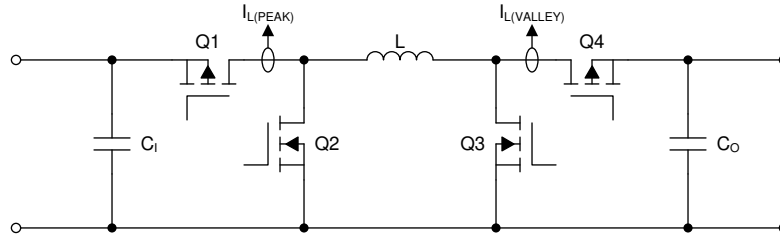

Figure 7-1. Power Stage Simplified Block Diagram

The device uses a trapezoidal inductor current to regulate its output under all operating conditions. Thus, the device only has one operating mode and does not display any of the mode-change transients or unpredictable switching displayed by many other buck-boost devices.

There are four phases of operation:

- Phase A – Q1 and Q3 are on and Q2 and Q4 are off
- Phase B – Q1 and Q4 are on and Q2 and Q3 are off
- Phase C – Q2 and Q4 are on and Q1 and Q3 are off
- Phase D – Q2 and Q3 are on and Q1 and Q4 are off

Figure 7-2 shows the inductor current waveform when $V_I > V_O$, Figure 7-3 shows the current waveform when $V_I = V_O$, and Figure 7-4 shows the current waveform when $V_I < V_O$.

Figure 7-2 through Figure 7-4 show the typical waveforms during continuous conduction mode (CCM) switching for three operating conditions. During discontinuous conduction mode (DCM), the typical inductor current waveforms look similar to CCM with Phase D at 0 A inductor current. In deep boost mode, where $V_I \ll V_O$, Phase C length gradually decreases to zero until the switching waveform becomes triangular.

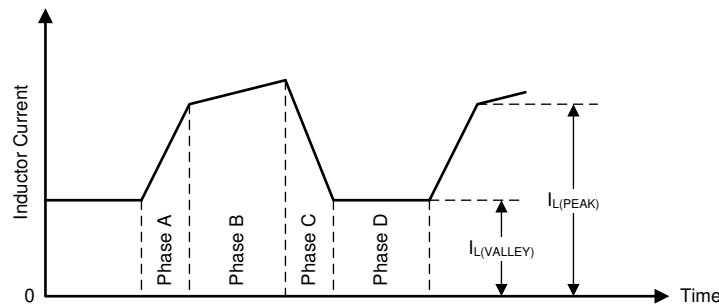

Figure 7-2. Inductor Current Waveform when $V_I > V_O$ (CCM)

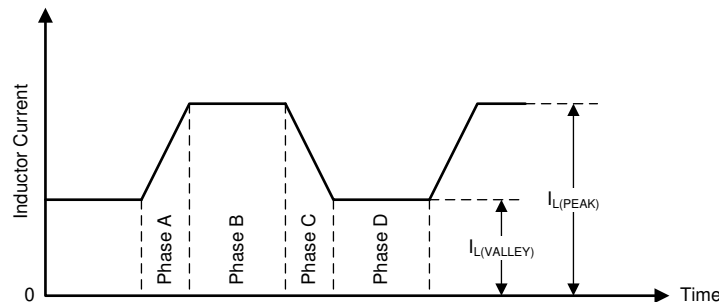

Figure 7-3. Inductor Current Waveform when $V_I = V_O$ (CCM)

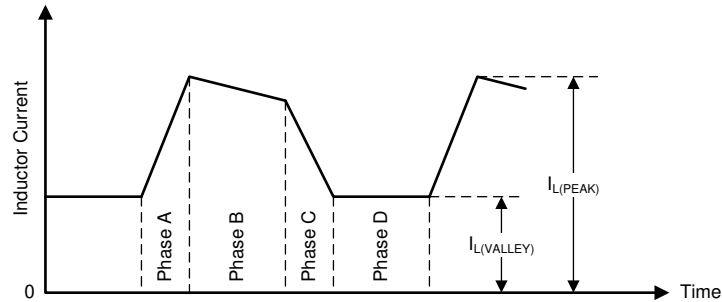

Figure 7-4. Inductor Current Waveform when $V_I < V_O$ (CCM)

The ideal relationship between V_I and V_O (that is, assuming no losses) is

$$V_O = V_I \left(\frac{t_{w(A)} + t_{w(B)}}{t_{w(B)} + t_{w(C)}} \right) \quad (1)$$

where

- V_I is the input voltage
- V_O is the output voltage
- $t_{w(A)}$ is the duration of phase A
- $t_{w(B)}$ is the duration of phase B
- $t_{w(C)}$ is the duration of phase C

By varying relative duration of each phase, the device can regulate V_O to be less than, equal to, or greater than V_I .

7.3.2 Device Enable / Disable

The device turns on when *all* the following conditions are true:

- The supply voltage is greater than the positive-going undervoltage lockout (UVLO) threshold.
- The EN pin is high.

The device turns off when *at least one* of the following conditions is true:

- The supply voltage is less than the negative-going UVLO threshold.
- The EN pin is low.

A complete state diagram is shown in [Figure 7-13](#).

After the device turns on, the internal reference system starts, then the trimming information and the CFG pins are read out. The device ignores any further changes to the CFG pins during device operation.

[Figure 7-5](#) shows the internal start-up sequence.

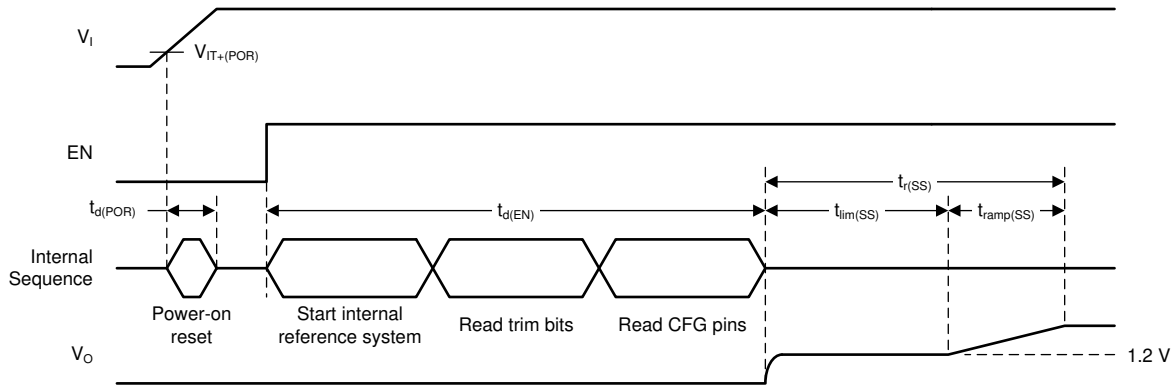

Figure 7-5. Internal Start-Up Sequence

7.3.3 Soft Start

The device has a soft-start feature that starts the device typically with 500-mA peak current limit until $V_O = 1.8\text{ V}$ and 500 μs elapsed when the input current limit is set to unlimited (see [Section 7.3.4](#)). Afterwards, the output voltage ramps in a series of discrete steps (see [Figure 7-6](#)).

- When $V_O \leq 1.8\text{ V}$, peak current is limited to 500 mA typical for 500 μs .
- When $V_O > 1.8\text{ V}$, each step is 100 mV high and has a duration of 125 μs .

The total soft-start ramp-up time can be calculated with [Equation 2](#).

$$t_{r(SS)} = V_O \times 1.25 \left[\frac{\text{ms}}{\text{V}} \right] - 1.75 [\text{ms}] \quad (2)$$

where

- $t_{r(SS)}$ is the rise time of the output voltage in milliseconds
- V_O is the output voltage in volts

[Figure 7-6](#) shows a typical start-up case.

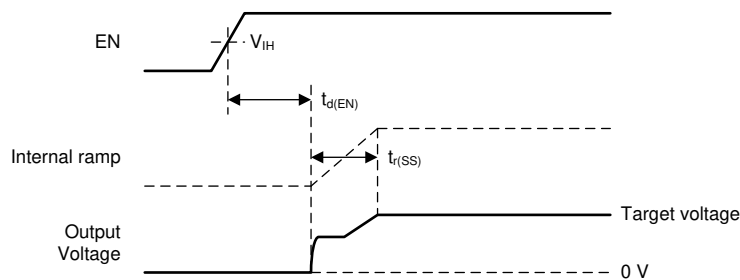

Figure 7-6. Start-Up Behavior

[Figure 7-7](#) illustrates the start-up step size behavior.

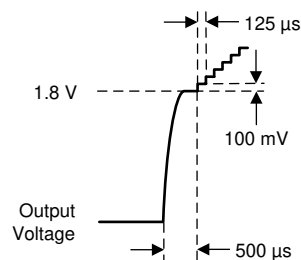

Figure 7-7. Typical Soft-Start Ramp Step Size

Table 7-1 shows the typical start-up time for a number of standard output voltages.

Table 7-1. Typical Start-Up Times

OUTPUT VOLTAGE	SOFT-START RAMP-UP TIME ($t_{r(SS)}$)	START-UP TIME ($t_{d(EN)} + t_{r(SS)}$)
1.8 V	0.5 ms	2 ms
2.5 V	1.375 ms	2.875 ms
3.3 V	2.375 ms	3.875 ms
5 V	4.5 ms	6 ms

If the output is prebiased – that is, the initial output voltage is not zero – the start-up behavior is as follows:

- If the prebias voltage is *lower* than the target voltage, the device does not start switching until the ramping output voltage is greater than the prebias voltage (see Figure 7-8).
- If the prebias voltage is *higher* than the target voltage, the device does not start to switch until the output voltage has decreased to the target voltage (see Figure 7-9). The device cannot actively discharge the output to the target voltage and relies on the load current to discharge the output capacitor and decrease the output voltage to the target value.

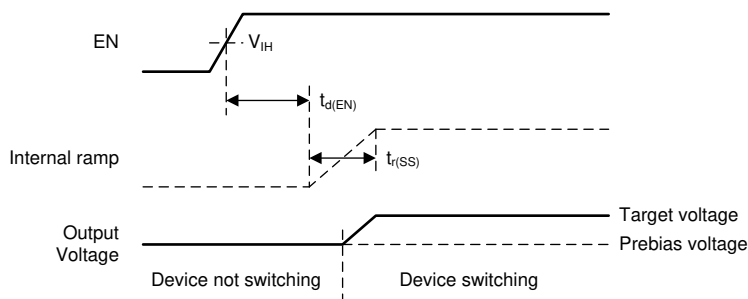

Figure 7-8. Start-Up Behavior into Prebiased (Low) Output

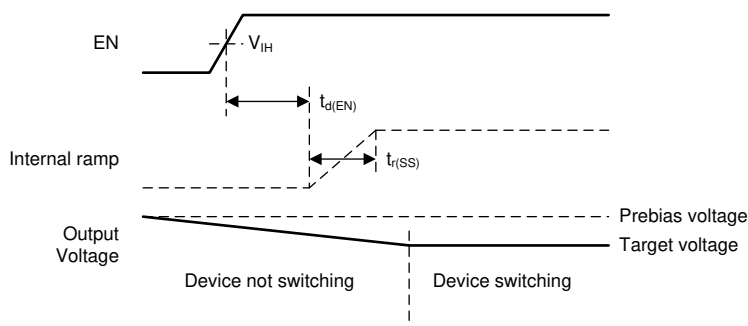

Figure 7-9. Start-Up Behavior into Prebiased (High) Output

7.3.4 Input Current Limit

The device can limit the current drawn from its supply, so that it can be used with batteries that do not support high peak currents. The input current limit is active during normal operation and at start-up to avoid high inrush current. The device has eight current limit settings:

- 1 mA
- 2.5 mA
- 5 mA
- 10 mA
- 25 mA
- 50 mA

- 100 mA
- Unlimited

CFG1 and CFG2 pins select which setting is active (see [Section 7.3.6](#)).

7.3.5 Dynamic Voltage Scaling

The device has a dynamic voltage scaling function to switch between the two output voltage settings. When the SEL pin changes state, the output voltage ramps to the new value in 100-mV steps. The duration of each step is 125 μs (see [Figure 7-10](#)).

The device does not actively discharge the output capacitor, when the output voltage ramps to a lower level. This leads to a longer output voltage settling time when light load is applied (see [Figure 7-11](#)). The settling time can be calculated with [Equation 3](#).

$$t_{\text{settle}} = C_O \times \frac{V_{O(\text{HIGH})} - V_{O(\text{LOW})}}{I_O} \quad (3)$$



Figure 7-10. Dynamic Voltage Scaling with High Load

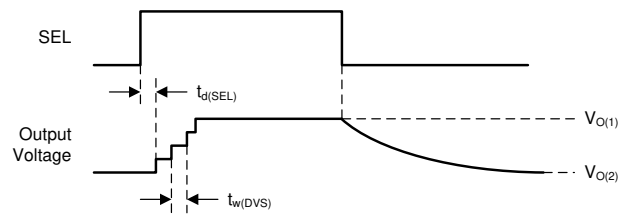

Figure 7-11. Dynamic Voltage Scaling with Light Load

7.3.6 Device Configuration (Resistor-to-Digital Interface)

The device has three configuration pins (CFG1, CFG2, and CFG3) that control its operation. When the device starts up, a resistor-to-digital (R2D) interface reads the values of the configuration resistors on the CFG pins and transfers the setting to an internal configuration register (see [Figure 7-12](#)).

- CFG1 and CFG2 set $V_{O(2)}$ level and the input current limit.
- CFG3 sets $V_{O(1)}$ level.

To reduce power consumption, the device reads the value of the resistors connected to the configuration pins during start-up and then disables these pins. Once the device has started to operate, changes to the configuration pins have no effect.

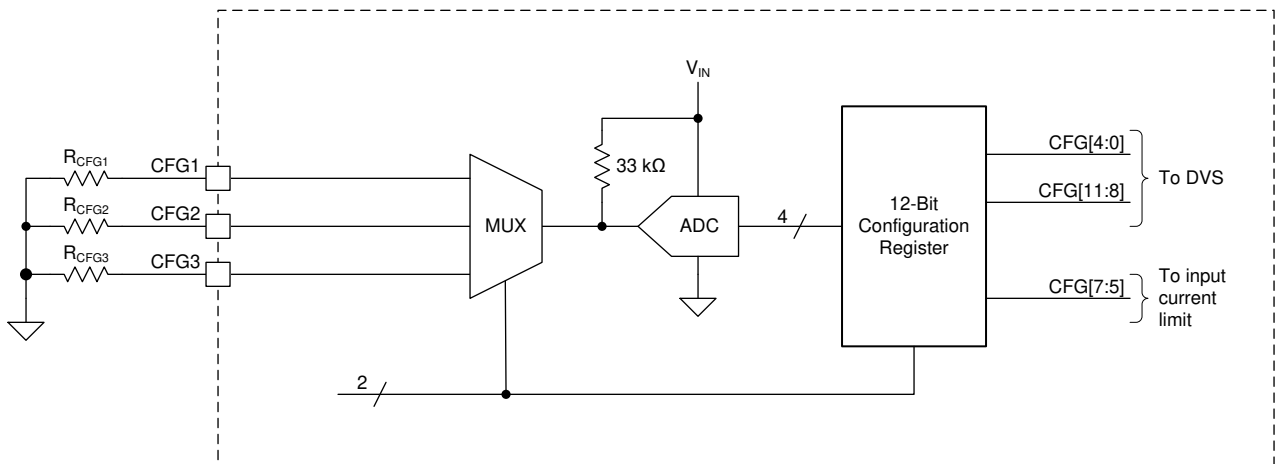

Figure 7-12. Resistor-to-Digital Interface Block Diagram

Table 7-2 summarizes the resistor values needed to configure the device for different input current limit and output voltage (SEL = high) settings. For correct operation, use resistors with a tolerance of $\pm 1\%$ or better and a temperature coefficient of ± 200 ppm or better.

Note

For correct operation, TI recommends that the total RMS error of the configuration resistors—including initial tolerance, temperature drift, and ageing—is less than $\pm 3\%$.

Table 7-2. Input Current Limit and Output Voltage (SEL = High) Settings

OUTPUT VOLTAGE - V ^{O(2)} (SEL = HIGH)		INPUT CURRENT LIMIT							
		UNLIMITED	100 mA	50 mA	25 mA	10 mA	5 mA	2.5 mA	1 mA
1.8 V	R _{CFG1}	0 Ω							
	R _{CFG2}	0 Ω	511 Ω	1.15 k Ω	1.87 k Ω	2.74 k Ω	3.83 k Ω	5.11 k Ω	6.49 k Ω
1.9 V	R _{CFG1}	511 Ω							
	R _{CFG2}	0 Ω	511 Ω	1.15 k Ω	1.87 k Ω	2.74 k Ω	3.83 k Ω	5.11 k Ω	6.49 k Ω
2.0 V	R _{CFG1}	1.15 k Ω							
	R _{CFG2}	0 Ω	511 Ω	1.15 k Ω	1.87 k Ω	2.74 k Ω	3.83 k Ω	5.11 k Ω	6.49 k Ω
2.1 V	R _{CFG1}	1.87 k Ω							
	R _{CFG2}	0 Ω	511 Ω	1.15 k Ω	1.87 k Ω	2.74 k Ω	3.83 k Ω	5.11 k Ω	6.49 k Ω
2.2 V	R _{CFG1}	2.74 k Ω							
	R _{CFG2}	0 Ω	511 Ω	1.15 k Ω	1.87 k Ω	2.74 k Ω	3.83 k Ω	5.11 k Ω	6.49 k Ω
2.3 V	R _{CFG1}	3.83 k Ω							
	R _{CFG2}	0 Ω	511 Ω	1.15 k Ω	1.87 k Ω	2.74 k Ω	3.83 k Ω	5.11 k Ω	6.49 k Ω
2.4 V	R _{CFG1}	5.11 k Ω							
	R _{CFG2}	0 Ω	511 Ω	1.15 k Ω	1.87 k Ω	2.74 k Ω	3.83 k Ω	5.11 k Ω	6.49 k Ω
2.5 V	R _{CFG1}	6.49 k Ω							
	R _{CFG2}	0 Ω	511 Ω	1.15 k Ω	1.87 k Ω	2.74 k Ω	3.83 k Ω	5.11 k Ω	6.49 k Ω
2.6 V	R _{CFG1}	8.25 k Ω							
	R _{CFG2}	0 Ω	511 Ω	1.15 k Ω	1.87 k Ω	2.74 k Ω	3.83 k Ω	5.11 k Ω	6.49 k Ω
2.7 V	R _{CFG1}	10.5 k Ω							
	R _{CFG2}	0 Ω	511 Ω	1.15 k Ω	1.87 k Ω	2.74 k Ω	3.83 k Ω	5.11 k Ω	6.49 k Ω
2.8 V	R _{CFG1}	13.3 k Ω							
	R _{CFG2}	0 Ω	511 Ω	1.15 k Ω	1.87 k Ω	2.74 k Ω	3.83 k Ω	5.11 k Ω	6.49 k Ω
2.9 V	R _{CFG1}	16.2 k Ω							
	R _{CFG2}	0 Ω	511 Ω	1.15 k Ω	1.87 k Ω	2.74 k Ω	3.83 k Ω	5.11 k Ω	6.49 k Ω
3.0 V	R _{CFG1}	20.5 k Ω							
	R _{CFG2}	0 Ω	511 Ω	1.15 k Ω	1.87 k Ω	2.74 k Ω	3.83 k Ω	5.11 k Ω	6.49 k Ω
3.1 V	R _{CFG1}	24.9 k Ω							
	R _{CFG2}	0 Ω	511 Ω	1.15 k Ω	1.87 k Ω	2.74 k Ω	3.83 k Ω	5.11 k Ω	6.49 k Ω
3.2 V	R _{CFG1}	30.1 k Ω							
	R _{CFG2}	0 Ω	511 Ω	1.15 k Ω	1.87 k Ω	2.74 k Ω	3.83 k Ω	5.11 k Ω	6.49 k Ω
3.3 V	R _{CFG1}	36.5 k Ω							
	R _{CFG2}	0 Ω	511 Ω	1.15 k Ω	1.87 k Ω	2.74 k Ω	3.83 k Ω	5.11 k Ω	6.49 k Ω
3.4 V	R _{CFG1}	0 Ω							
	R _{CFG2}	8.25 k Ω	10.5 k Ω	13.3 k Ω	16.2 k Ω	20.5 k Ω	24.9 k Ω	30.1 k Ω	36.5 k Ω
3.5 V	R _{CFG1}	511 Ω							
	R _{CFG2}	8.25 k Ω	10.5 k Ω	13.3 k Ω	16.2 k Ω	20.5 k Ω	24.9 k Ω	30.1 k Ω	36.5 k Ω

Table 7-2. Input Current Limit and Output Voltage (SEL = High) Settings (continued)

OUTPUT VOLTAGE - V ^{O(2)} (SEL = HIGH)		INPUT CURRENT LIMIT							
		UNLIMITED	100 mA	50 mA	25 mA	10 mA	5 mA	2.5 mA	1 mA
3.6 V	R _{CFG1}	1.15 kΩ							
	R _{CFG2}	8.25 kΩ	10.5 kΩ	13.3 kΩ	16.2 kΩ	20.5 kΩ	24.9 kΩ	30.1 kΩ	36.5 kΩ
3.7 V	R _{CFG1}	1.87 kΩ							
	R _{CFG2}	8.25 kΩ	10.5 kΩ	13.3 kΩ	16.2 kΩ	20.5 kΩ	24.9 kΩ	30.1 kΩ	36.5 kΩ
3.8 V	R _{CFG1}	2.74 kΩ							
	R _{CFG2}	8.25 kΩ	10.5 kΩ	13.3 kΩ	16.2 kΩ	20.5 kΩ	24.9 kΩ	30.1 kΩ	36.5 kΩ
3.9 V	R _{CFG1}	3.83 kΩ							
	R _{CFG2}	8.25 kΩ	10.5 kΩ	13.3 kΩ	16.2 kΩ	20.5 kΩ	24.9 kΩ	30.1 kΩ	36.5 kΩ
4.0 V	R _{CFG1}	5.11 kΩ							
	R _{CFG2}	8.25 kΩ	10.5 kΩ	13.3 kΩ	16.2 kΩ	20.5 kΩ	24.9 kΩ	30.1 kΩ	36.5 kΩ
4.1 V	R _{CFG1}	6.49 kΩ							
	R _{CFG2}	8.25 kΩ	10.5 kΩ	13.3 kΩ	16.2 kΩ	20.5 kΩ	24.9 kΩ	30.1 kΩ	36.5 kΩ
4.2 V	R _{CFG1}	8.25 kΩ							
	R _{CFG2}	8.25 kΩ	10.5 kΩ	13.3 kΩ	16.2 kΩ	20.5 kΩ	24.9 kΩ	30.1 kΩ	36.5 kΩ
4.3 V	R _{CFG1}	10.5 kΩ							
	R _{CFG2}	8.25 kΩ	10.5 kΩ	13.3 kΩ	16.2 kΩ	20.5 kΩ	24.9 kΩ	30.1 kΩ	36.5 kΩ
4.4 V	R _{CFG1}	13.3 kΩ							
	R _{CFG2}	8.25 kΩ	10.5 kΩ	13.3 kΩ	16.2 kΩ	20.5 kΩ	24.9 kΩ	30.1 kΩ	36.5 kΩ
4.5 V	R _{CFG1}	16.2 kΩ							
	R _{CFG2}	8.25 kΩ	10.5 kΩ	13.3 kΩ	16.2 kΩ	20.5 kΩ	24.9 kΩ	30.1 kΩ	36.5 kΩ
4.6 V	R _{CFG1}	20.5 kΩ							
	R _{CFG2}	8.25 kΩ	10.5 kΩ	13.3 kΩ	16.2 kΩ	20.5 kΩ	24.9 kΩ	30.1 kΩ	36.5 kΩ
4.7 V	R _{CFG1}	24.9 kΩ							
	R _{CFG2}	8.25 kΩ	10.5 kΩ	13.3 kΩ	16.2 kΩ	20.5 kΩ	24.9 kΩ	30.1 kΩ	36.5 kΩ
4.8 V	R _{CFG1}	30.1 kΩ							
	R _{CFG2}	8.25 kΩ	10.5 kΩ	13.3 kΩ	16.2 kΩ	20.5 kΩ	24.9 kΩ	30.1 kΩ	36.5 kΩ
5.0 V	R _{CFG1}	36.5 kΩ							
	R _{CFG2}	8.25 kΩ	10.5 kΩ	13.3 kΩ	16.2 kΩ	20.5 kΩ	24.9 kΩ	30.1 kΩ	36.5 kΩ

Table 7-3 summarizes the resistor values needed to configure the device for different output voltage (SEL = low) settings. For correct operation, use resistors with a tolerance of ±1% or better and a temperature coefficient of better than ±200 ppm.

Table 7-3. Output Voltage (SEL Pin = Low) Settings

OUTPUT VOLTAGE - V _{O(1)} (SEL = LOW)	R _{CFG3}
1.8 V	0 Ω
2.0 V	511 Ω
2.1 V	1.15 kΩ
2.2 V	1.87 kΩ
2.3 V	2.74 kΩ
2.4 V	3.83 kΩ
2.5 V	5.11 kΩ
2.6 V	6.49 kΩ
2.7 V	8.25 kΩ

**Table 7-3. Output Voltage (SEL Pin = Low) Settings
(continued)**

OUTPUT VOLTAGE - $V_{O(1)}$ (SEL = LOW)	R_{CFG3}
2.8 V	10.5 k Ω
3.0 V	13.3 k Ω
3.3 V	16.2 k Ω
3.6 V	20.5 k Ω
4.0 V	24.9 k Ω
4.5 V	30.1 k Ω
5.0 V	36.5 k Ω

7.3.7 SEL Pin

The SEL pin selects which configuration bits control the output voltage.

- When SEL = high, the output voltage $V_{O(2)}$ is set.
- When SEL = low, the output voltage $V_{O(1)}$ is set.

7.3.8 Short-Circuit Protection

7.3.8.1 Current Limit Setting = 'Unlimited'

The device has a inbuilt short circuit protection function to limit the current through Q1. The maximum current that flows is limited by the peak current limit. The output voltage decreases if the load is higher than the peak current limit. If the output voltage falls below 1.25 typically, the short circuit protection is activated. With short circuit protection activated the input current is limited to 26 mA on average.

The device automatically restarts to normal operation after the short condition is removed.

7.3.8.2 Current Limit Setting = 1 mA to 100 mA

The input current limiting function automatically limits current during a short-circuit condition. The device regulates the average input current for as long as the short-circuit condition exists. If the output voltage falls below 1.25 V typically, the short circuit protection is activated. For input current limit settings of 100 mA, 50 mA and 25 mA, the short circuit protection limits the input current to 26 mA on average. For input current limit setting of 10 mA, 5 mA, 2.5 mA, and 1 mA, the short circuit protection limits the input current to slightly above the typical values for each setting. [Table 7-4](#) shows the typical short circuit currents for each input current limit setting.

The device automatically restarts to previous operation after the short condition is removed.

Table 7-4. Typical Input Current During Short Circuit Condition ($V_O < 1.25$ V Typically) for All Input Current Limit Settings

INPUT CURRENT LIMIT SETTING	TYPICAL SHORT CIRCUIT INPUT CURRENT
1 mA	1.2 mA
2.5 mA	2.8 mA
5 mA	5.2 mA
10 mA	12 mA
25 mA	26 mA
50 mA	26 mA
100 mA	26 mA
Unlimited	26 mA

7.3.9 Thermal Shutdown

The device has a thermal shutdown function that disables the device if it gets too hot for correct operation. When the device cools down, it automatically restarts operation after a typical delay of $t_{d(RESTART)} = 10$ ms. The device starts with the soft-start feature (see [Section 7.3.3](#)) and keeps the previously read CFG pin setting.

7.4 Device Functional Modes

The device has two functional modes: on and off. The device enters the on mode when the voltage on the VIN pin is higher than the UVLO threshold and a high logic level is applied to the EN pin. The device enters the off mode when the voltage on the VIN pin is lower than the UVLO threshold or a low logic level is applied to the EN pin.

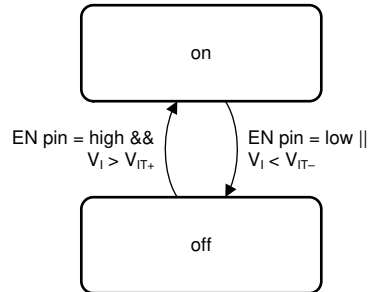

Figure 7-13. Device Functional Modes

8 Application and Implementation

Note

Information in the following applications sections is not part of the TI component specification, and TI does not warrant its accuracy or completeness. TI's customers are responsible for determining suitability of components for their purposes. Customers should validate and test their design implementation to confirm system functionality.

8.1 Application Information

The TPS63900 is a high efficiency, non-inverting buck-boost converter with an extremely low quiescent current, suitable for applications that need a regulated output voltage from an input supply that can be higher or lower than the output voltage. The input current limit and output voltage are set through resistors connected to the three CFGx pins.

8.2 Typical Application

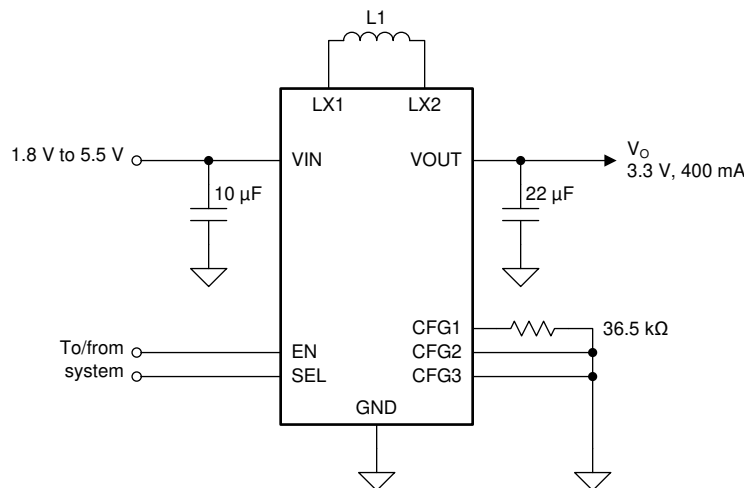

Figure 8-1. 3.3 V_{OUT} Typical Application

8.2.1 Design Requirements

The design guideline provides a component selection to operate the device within [Section 6.3](#).

Table 8-1. Matrix of Output Capacitor and Inductor Combinations

NOMINAL INDUCTOR VALUE [µH] ⁽¹⁾	NOMINAL OUTPUT CAPACITOR VALUE [µF] ⁽²⁾				
	10	22	47	100	≥ 300
2.2	+ ⁽³⁾	+ ⁽⁴⁾	+	+	+ ⁽⁵⁾

- (1) Inductor tolerance and current derating is anticipated. The effective inductance can vary by 20% and –30%.
- (2) Capacitance tolerance and DC bias voltage derating is anticipated. The effective capacitance can vary by 20% and –50%.
- (3) Output voltage ripple increases versus typical application.
- (4) Typical application. Other check marks indicate possible filter combinations.
- (5) Start-up time increased.

8.2.2 Detailed Design Procedure

The first step is the selection of the output filter components. To simplify this process, [Section 6.3](#) outlines minimum and maximum values for inductance and capacitance. Tolerance and derating must be taken into account when selecting nominal inductance and capacitance.

8.2.2.1 Custom Design with WEBENCH Tools

[Click here](#) to create a custom design using the TPS63900 device with the WEBENCH® Power Designer.

1. Start by entering your V_{IN} , V_{OUT} and I_{OUT} requirements.
2. Optimize your design for key parameters like efficiency, footprint or cost using the optimizer dial and compare this design with other possible solutions from Texas Instruments.
3. WEBENCH Power Designer provides you with a customized schematic along with a list of materials with real time pricing and component availability.
4. In most cases, you will also be able to:
 - Run electrical simulations to see important waveforms and circuit performance,
 - Run thermal simulations to understand the thermal performance of your board,
 - Export your customized schematic and layout into popular CAD formats,
 - Print PDF reports for the design, and share your design with colleagues.
5. Get more information about WEBENCH tools at www.ti.com/webench.

8.2.2.2 Inductor Selection

The inductor selection is affected by several parameters such as inductor ripple current, output voltage ripple, transition point into Power Save Mode, and efficiency. See [Table 8-2](#) for typical inductors.

For high efficiencies, the inductor must have a low DC resistance to minimize conduction losses. Especially at high-switching frequencies, the core material has a high impact on efficiency. When using small chip inductors, the efficiency is reduced mainly due to higher inductor core losses. This needs to be considered when selecting the appropriate inductor. The inductor value determines the inductor ripple current. The larger the inductor value, the smaller the inductor ripple current and the lower the core and conduction losses of the converter. Conversely, larger inductor values cause a slower load transient response. To avoid saturation of the inductor, the peak current for the inductor in steady state operation is calculated using [Equation 5](#). Only the equation which defines the switch current in boost mode is shown, because this provides the highest value of current and represents the critical current value for selecting the right inductor.

$$\text{Duty Cycle Boost} \quad D = \frac{V_{OUT} - V_{IN}}{V_{OUT}} \quad (4)$$

$$I_{PEAK} = \frac{I_{out}}{\eta \times (1 - D)} + \frac{V_{in} \times D}{2 \times f \times L} \quad (5)$$

where:

- D = Duty Cycle in Boost mode
- f = Converter switching frequency
- L = Inductor value
- η = Estimated converter efficiency (use the number from the efficiency curves or 0.9 as an assumption)

Note

The calculation must be done for the minimum input voltage in boost mode.

Calculating the maximum inductor current using the actual operating conditions gives the minimum saturation current of the inductor needed. It is recommended to choose an inductor with a saturation current 20% higher than the value calculated using [Equation 5](#). Possible inductors are listed in [Table 8-2](#).

Table 8-2. List of Recommended Inductors

INDUCTOR VALUE [μ H] ⁽¹⁾	SATURATION CURRENT [A]	DCR [m Ω]	PART NUMBER	MANUFACTURER	SIZE (LxWxH mm)
2.2	3.5	21	XFL4020-222ME	Coilcraft	4 x 4 x 2
2.2	1.7	72	SRN3015TA-2R2M	Bourns	3 x 3 x 1.5
2.2	3.1	97	DFE252010F-2R2M	Murata	2.5 x 2 x 1
2.2	2.4	116	DFE201612E-2R2M	Murata	2.0 x 1.6 x 1.2

Table 8-2. List of Recommended Inductors (continued)

INDUCTOR VALUE [μ H] ⁽¹⁾	SATURATION CURRENT [A]	DCR [m Ω]	PART NUMBER	MANUFACTURER	SIZE (LxWxH mm)
2.2	2.0	190	DFE201210U-2R2M	Murata	2.0 x 1.2 x 1.0

(1) See the [Third-party Products Disclaimer](#).

8.2.2.3 Output Capacitor Selection

For the output capacitor, use of small ceramic capacitors placed as close as possible to the VOUT and GND pins of the IC is recommended. The recommended nominal output capacitor value is a single 22 μ F. If, for any reason, the application requires the use of large capacitors which cannot be placed close to the IC, use a smaller ceramic capacitor in parallel to the large capacitor. The small capacitor must be placed as close as possible to the VOUT and GND pins of the IC.

It is important that the effective capacitance is given according to the recommended value in [Section 6.3](#). In general, consider DC bias effects resulting in less effective capacitance. The choice of the output capacitance is mainly a tradeoff between size and transient behavior as higher capacitance reduces transient response overshoot and undershoot and increases transient response time. Possible output capacitors are listed in [Table 8-3](#).

There is no upper limit for the output capacitance value.

At light load currents the output voltage ripple is dependent on the output capacitor value. Larger output capacitors reduce the output voltage ripple. The leakage current of the output capacitor adds to the overall quiescent current.

Table 8-3. List of Recommended Capacitors

CAPACITOR VALUE [μ F] ⁽¹⁾	VOLTAGE RATING [V]	PART NUMBER	MANUFACTURER	SIZE (METRIC)
22	6.3	GRM187R60J226ME15	Murata	0603 (1608)
22	6.3	GRM219R60J476ME44	Murata	0805 (3210)
47	6.3	GRM188R60J476ME15	Murata	0603 (1608)

(1) See [Third-party Products Disclaimer](#).

8.2.2.4 Input Capacitor Selection

A 10- μ F input capacitor is recommended to improve line transient behavior of the regulator and EMI behavior of the total power supply circuit. An X5R or X7R ceramic capacitor placed as close as possible to the VIN and GND pins of the IC is recommended. This capacitance can be increased without limit. If the input supply is located more than a few inches from the TPS63900 converter additional bulk capacitance can be required in addition to the ceramic bypass capacitors. An electrolytic or tantalum capacitor with a value of 47 μ F is a typical choice.

When operating from a high impedance source, a larger input buffer capacitor is recommended to avoid voltage drops during start-up and load transients.

The input capacitor can be increased without any limit for better input voltage filtering. The leakage current of the input capacitor adds to the overall quiescent current.

Table 8-4. List of Recommended Capacitors

CAPACITOR VALUE [μ F] ⁽¹⁾	VOLTAGE RATING [V]	PART NUMBER	MANUFACTURER	SIZE (METRIC)
10	6.3	GRM188R60J106ME47	Murata	0603 (1608)
10	10	GRM188R61A106ME69	Murata	0603 (1608)
22	6.3	GRM187R60J226ME15	Murata	0603 (1608)

(1) See [Third-party Products Disclaimer](#).

8.2.2.5 Setting The Output Voltage

The output voltage is set with CFGx pins (see [Section 7.3.6](#)).

8.2.3 Application Curves

Table 8-5. Components for Application Characteristic Curves for $V_{OUT} = 3.3\text{ V}$

REFERENCE ⁽¹⁾	DESCRIPTION ⁽²⁾	PART NUMBER	MANUFACTURER
U1	400-mA ultra low Iq Buck-Boost Converter (2.5 mm x 2.5 mm QFN)	TPS63900DSK	Texas Instruments
L1	2.2 μH , 2.5 mm x 2 mm x 1.2 mm, 3.3 A, 82 m Ω	DFE252012F-2R2M	Murata
C1	10 μF , 0603, Ceramic Capacitor, $\pm 20\%$, 6.3 V	GRM188R60J106ME47	Murata
C2	22 μF , 0603, Ceramic Capacitor, $\pm 20\%$, 6.3 V	GRM187R60J226ME15	Murata
CFG1	36.5 k Ω , 0603 Resistor, 1%, 100 mW	Standard	Standard
CFG2	0 Ω , 0603 Resistor, 1%, 100 mW	Standard	Standard
CFG3	0 Ω , 0603 Resistor, 1%, 100 mW	Standard	Standard

- (1) See [Third-Party Products Disclaimer](#)
(2) For other output voltages, refer to [Table 8-1](#) for resistor values.

Table 8-6. Typical Characteristics Curves

PARAMETER	CONDITIONS	FIGURE
Output Current Capability		
Typical Output Current Capability versus Input Voltage	$V_O = 1.8\text{ V to }5.0\text{ V}$	Figure 8-2
Switching Frequency		
Typical Burst Switching Frequency versus Output Current	$V_I = 3.3\text{ V}$, $V_O = 1.8\text{ V to }5.0\text{ V}$	Figure 8-3
Typical Burst Switching Frequency versus Output Current	$V_I = 2.0\text{ V}$, $V_O = 1.8\text{ V to }5.0\text{ V}$	Figure 8-4
Typical Burst Switching Frequency versus Output Current	$V_I = 5.2\text{ V}$, $V_O = 1.8\text{ V to }5.0\text{ V}$	Figure 8-5
Efficiency		
Efficiency versus Output Current	$V_I = 1.8\text{ V to }5.5\text{ V}$, $V_O = 1.8\text{ V}$	Figure 8-6
Efficiency versus Output Current	$V_I = 1.8\text{ V to }5.5\text{ V}$, $V_O = 3.3\text{ V}$	Figure 8-7
Efficiency versus Output Current	$V_I = 1.8\text{ V to }5.5\text{ V}$, $V_O = 5.0\text{ V}$	Figure 8-8
Efficiency versus Input Voltage	$I_O = 1\text{ }\mu\text{A to }400\text{ mA}$, $V_O = 3.3\text{ V}$	Figure 8-9
Switching Waveforms		
Switching Waveforms, Boost Operation	$V_I = 1.8\text{ V}$, $V_O = 3.3\text{ V}$	Figure 8-10
Switching Waveforms, Boost Operation	$V_I = 2.8\text{ V}$, $V_O = 3.3\text{ V}$	Figure 8-11
Switching Waveforms, Buck-Boost Operation	$V_I = 3.3\text{ V}$, $V_O = 3.3\text{ V}$	Figure 8-12
Switching Waveforms, Buck Operation	$V_I = 4.0\text{ V}$, $V_O = 3.3\text{ V}$	Figure 8-13
Output Voltage Ripple		
Output Voltage Ripple	$V_I = 2.0\text{ V}$, $V_O = 1.8\text{ V to }5.0\text{ V}$	Figure 8-14
Output Voltage Ripple	$V_I = 3.3\text{ V}$, $V_O = 1.8\text{ V to }5.0\text{ V}$	Figure 8-15
Output Voltage Ripple	$V_I = 5.2\text{ V}$, $V_O = 1.8\text{ V to }5.0\text{ V}$	Figure 8-16
Output Voltage Ripple over Temperature	$V_I = 3.3\text{ V}$, $V_O = 3.6\text{ V}$	Figure 8-17
Regulation Accuracy		
Load Regulation	$V_O = 3.3\text{ V}$	Figure 8-18
Line Regulation	$V_I = 1.8\text{ V to }5.0\text{ V}$, Load = 1 mA	Figure 8-19
Transient Performance		
Line Transient, Light Load	$V_I = 2.5\text{ V to }4.2\text{ V}$, $V_O = 3.3\text{ V}$, Load = 1 mA	Figure 8-20
Line Transient, High Load	$V_I = 2.5\text{ V to }4.2\text{ V}$, $V_O = 3.3\text{ V}$, Load = 100 mA	Figure 8-21
Load Transient, 100 mA Step	$V_I = 1.8\text{ V}$, $V_O = 3.3\text{ V}$, Load = 0 mA to 100 mA	Figure 8-22
Load Transient, 100 mA Step	$V_I = 3.3\text{ V}$, $V_O = 3.3\text{ V}$, Load = 0 mA to 100 mA	Figure 8-23
Load Transient, 100 mA Step	$V_I = 1.8\text{ V}$, $V_O = 3.3\text{ V}$, Load = 0 mA to 100 mA	Figure 8-24
Load Transient, 300 mA Step	$V_I = 3.3\text{ V}$, $V_O = 1.8\text{ V}$, Load = 0 mA to 300 mA	Figure 8-25
Load Transient, 300 mA Step	$V_I = 3.3\text{ V}$, $V_O = 3.3\text{ V}$, Load = 0 mA to 300 mA	Figure 8-26

Table 8-6. Typical Characteristics Curves (continued)

PARAMETER	CONDITIONS	FIGURE
Load Transient, 300 mA Step	$V_I = 5.5\text{ V}$, $V_O = 3.3\text{ V}$, Load = 0 mA to 300 mA	Figure 8-27
Start-up		
Start-up Behavior from Rising Enable	$V_I = 3.3\text{ V}$, $V_O = 3.3\text{ V}$, Load = 100 mA	Figure 8-28
Start-up Behavior from Rising Enable	$V_I = 1.8\text{ V}$, $V_O = 1.8\text{ V}$, Load = 10 μA	Figure 8-29
Start-up Behavior from Rising Enable	$V_I = 1.8\text{ V}$, $V_O = 5.0\text{ V}$, Load = 10 μA	Figure 8-30
Start-up Behavior from Rising Enable	$V_I = 1.8\text{ V}$, $V_O = 5.0\text{ V}$, Load = 1000 μF	Figure 8-31
ICL (Input Current Limit)		
Start-up with 1 mA ICL	$V_I = 3.3\text{ V}$, $V_O = 3.3\text{ V}$, $C_O = 300\text{ }\mu\text{F}$	Figure 8-32
Start-up with 2.5 mA ICL	$V_I = 3.3\text{ V}$, $V_O = 3.3\text{ V}$, $C_O = 300\text{ }\mu\text{F}$	Figure 8-33
Start-up with 5 mA ICL	$V_I = 3.3\text{ V}$, $V_O = 3.3\text{ V}$, $C_O = 300\text{ }\mu\text{F}$	Figure 8-34
Start-up with 10 mA ICL	$V_I = 3.3\text{ V}$, $V_O = 3.3\text{ V}$, $C_O = 300\text{ }\mu\text{F}$	Figure 8-35
Start-up with 25 mA ICL	$V_I = 3.3\text{ V}$, $V_O = 3.3\text{ V}$, $C_O = 300\text{ }\mu\text{F}$	Figure 8-36
Start-up with 50 mA ICL	$V_I = 3.3\text{ V}$, $V_O = 3.3\text{ V}$, $C_O = 300\text{ }\mu\text{F}$	Figure 8-37
Start-up with 100 mA ICL	$V_I = 3.3\text{ V}$, $V_O = 3.3\text{ V}$, $C_O = 300\text{ }\mu\text{F}$	Figure 8-38
Short Circuit Behavior		
Short Circuit Behavior	$V_I = 3.3\text{ V}$, $V_O = 1.8\text{ V}$	Figure 8-39
Short Circuit Behavior	$V_I = 3.3\text{ V}$, $V_O = 3.3\text{ V}$	Figure 8-40
Short Circuit Behavior	$V_I = 3.3\text{ V}$, $V_O = 5.0\text{ V}$	Figure 8-41
DVS (Digital Voltage Scaling)		
DVS Behavior at Light Load	$V_I = 3.3\text{ V}$, $V_{O(1)} = 2.2\text{ V}$, $V_{O(2)} = 3.6\text{ V}$, Load = 1 k Ω	Figure 8-42
DVS Behavior at High Load	$V_I = 3.3\text{ V}$, $V_{O(1)} = 2.2\text{ V}$, $V_{O(2)} = 3.6\text{ V}$, Load = 30 Ω	Figure 8-43

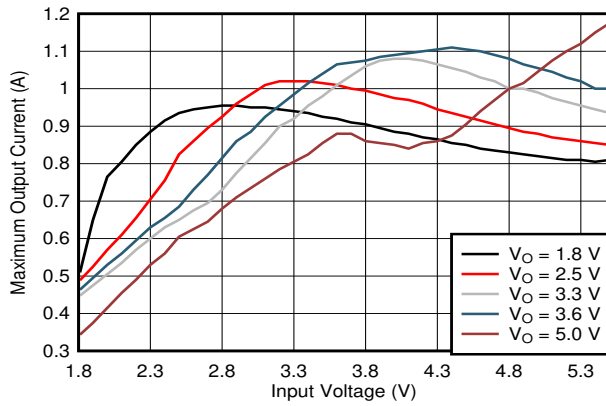

Figure 8-2. Typical Output Current Capability versus Input Voltage

$T_A = 25^\circ\text{C}$

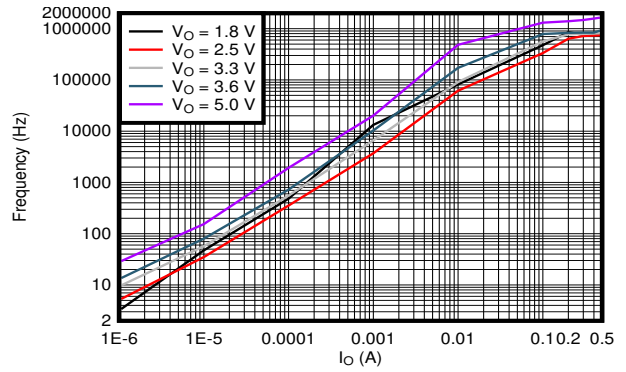

Figure 8-3. Typical Burst Switching Frequency versus Output Current

$V_I = 3.3\text{ V}$

$T_A = 25^\circ\text{C}$

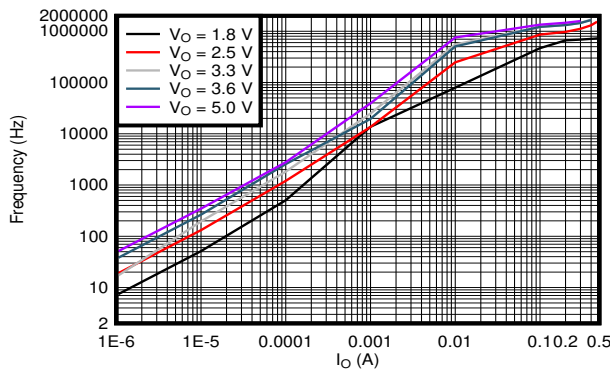

Figure 8-4. Typical Burst Switching Frequency versus Output Current

$V_I = 2.0\text{ V}$

$T_A = 25^\circ\text{C}$

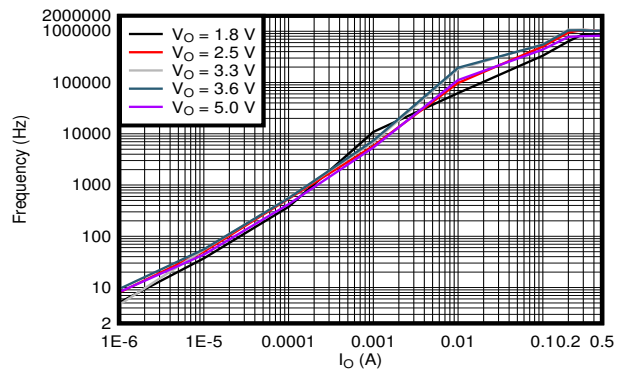

Figure 8-5. Typical Burst Switching Frequency versus Output Current

$V_I = 5.2\text{ V}$

$T_A = 25^\circ\text{C}$

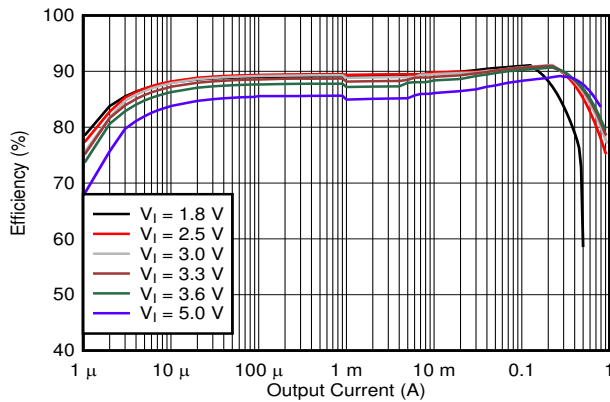

Figure 8-6. Efficiency versus Output Current

$V_O = 1.8\text{ V}$

$T_A = 25^\circ\text{C}$

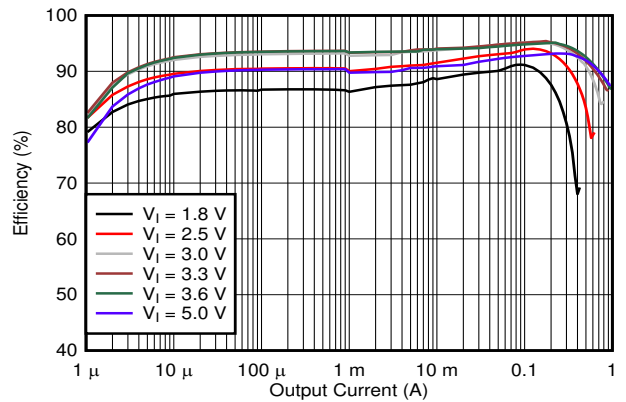
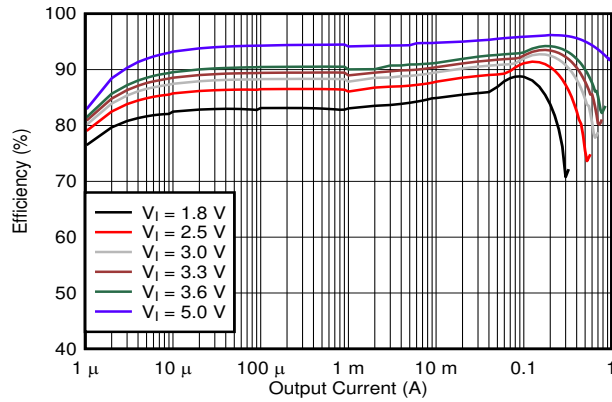

Figure 8-7. Efficiency versus Output Current

$V_O = 3.3\text{ V}$

$T_A = 25^\circ\text{C}$



$V_O = 5.0\text{ V}$ $T_A = 25^\circ\text{C}$

Figure 8-8. Efficiency versus Output Current

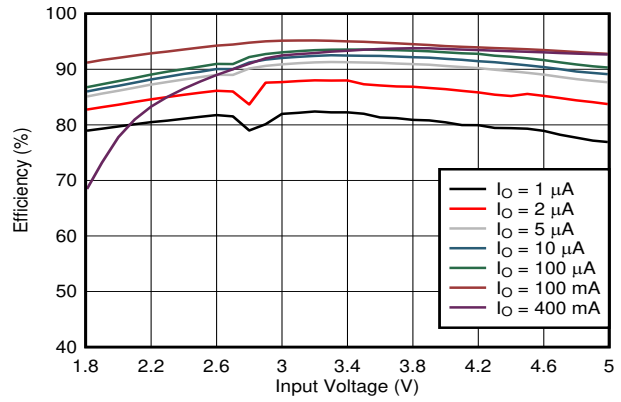

$V_O = 3.3\text{ V}$ $T_A = 25^\circ\text{C}$

Figure 8-9. Efficiency versus Input Voltage

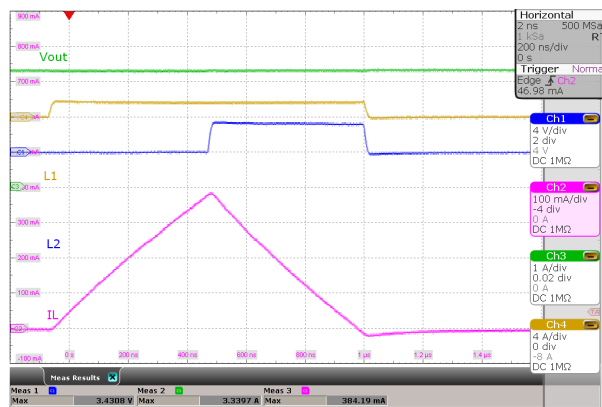

$V_I = 1.8\text{ V}, V_O = 3.3\text{ V}$ No load

Figure 8-10. Switching Waveforms, Boost Operation

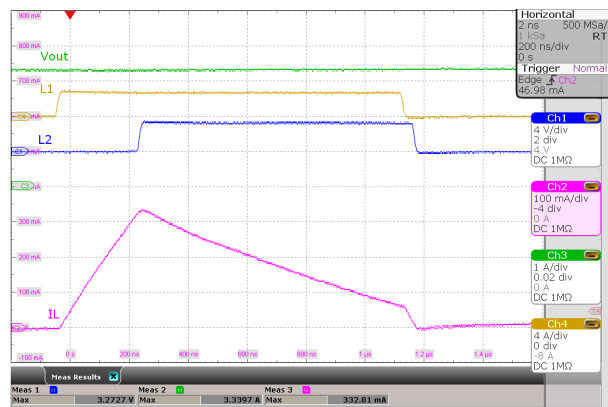

$V_I = 2.8\text{ V}, V_O = 3.3\text{ V}$ No load

Figure 8-11. Switching Waveforms, Boost Operation

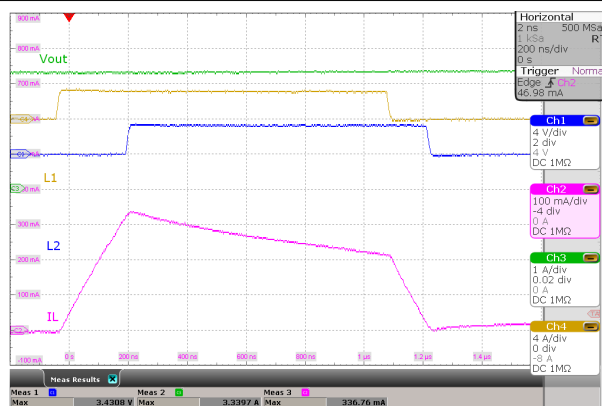

$V_I = 3.3\text{ V}, V_O = 3.3\text{ V}$ No load

Figure 8-12. Switching Waveforms, Buck-Boost Operation

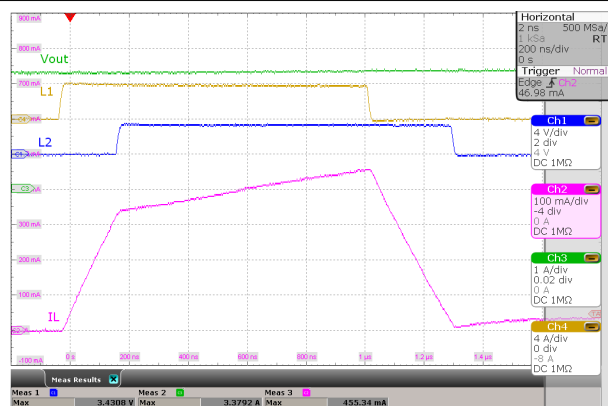

$V_I = 4.0\text{ V}, V_O = 3.3\text{ V}$ No load

Figure 8-13. Switching Waveforms, Buck Operation

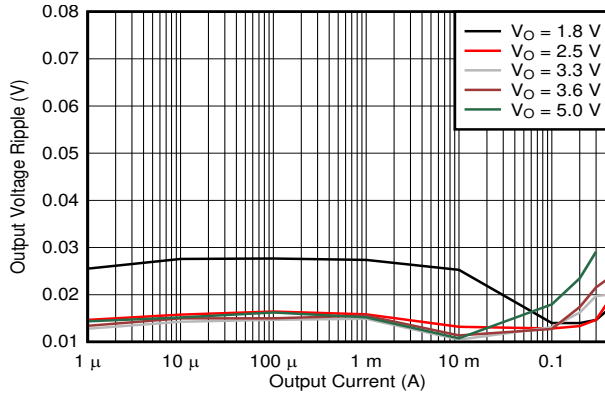

$V_I = 2.0\text{ V}$ $T_A = 25^\circ\text{C}$

Figure 8-14. Output Voltage Ripple

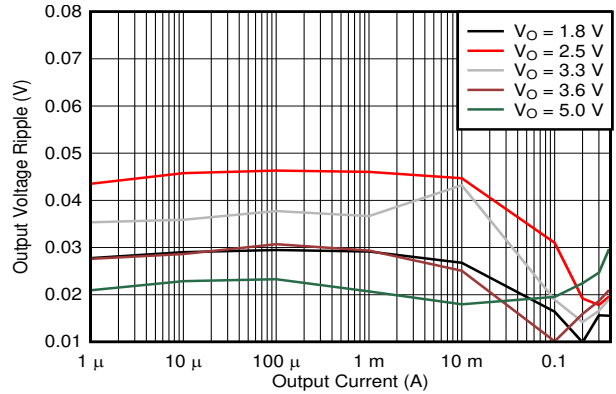

$V_I = 3.3\text{ V}$ $T_A = 25^\circ\text{C}$

Figure 8-15. Output Voltage Ripple

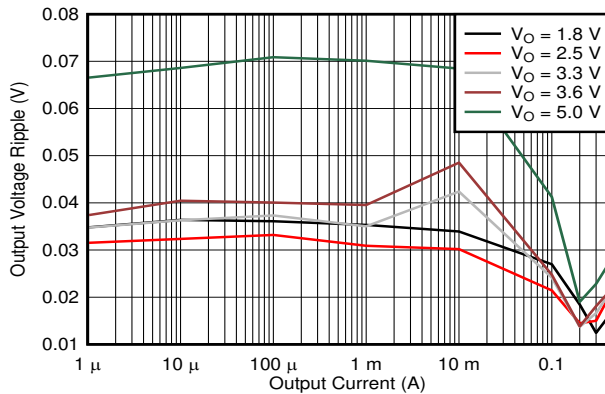

$V_I = 5.2\text{ V}$ $T_A = 25^\circ\text{C}$

Figure 8-16. Output Voltage Ripple

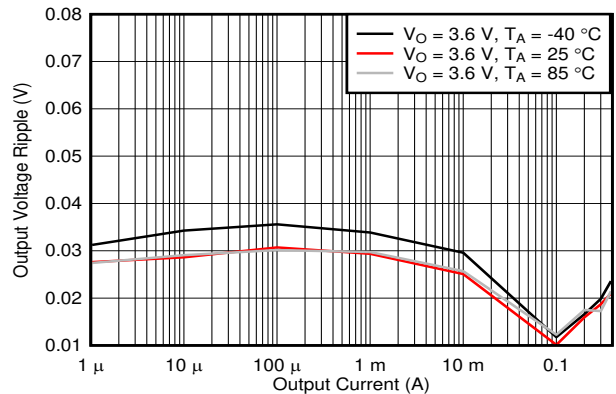

$V_I = 3.3\text{ V}, V_O = 3.6\text{ V}$

Figure 8-17. Output Voltage Ripple over Temperature

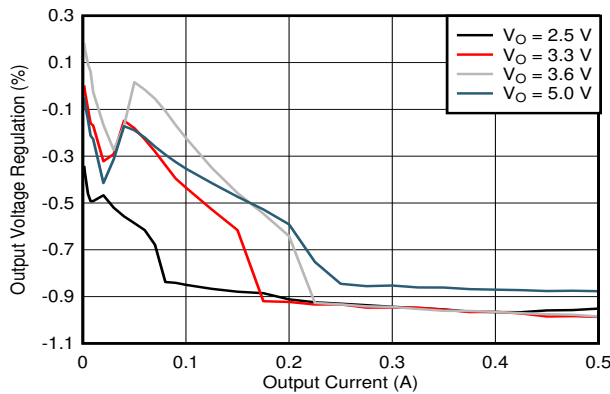

$V_O = 3.3\text{ V}$ $T_A = 25^\circ\text{C}$

Figure 8-18. Load Regulation

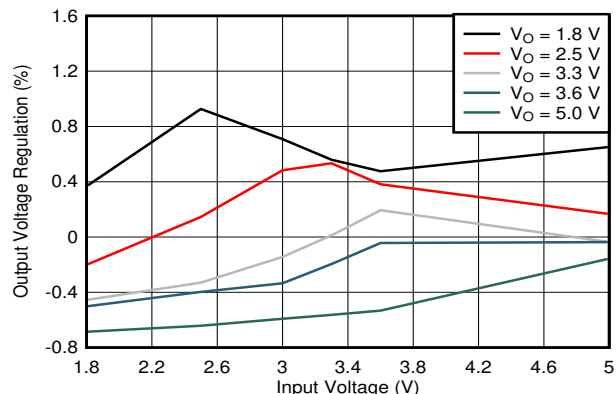

$V_I = 1.8\text{ V to }5.0\text{ V}$ $\text{Load} = 1\text{ mA}, T_A = 25^\circ\text{C}$

Figure 8-19. Line Regulation

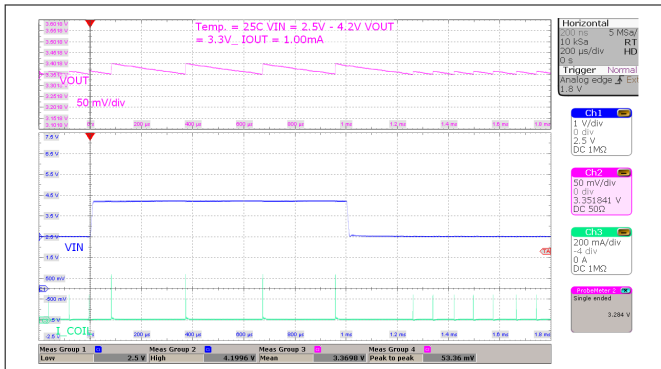

$V_I = 2.5\text{ V to }4.2\text{ V}$, $V_O = 3.3\text{ V}$ Load = 1 mA

Figure 8-20. Line Transient, Light Load

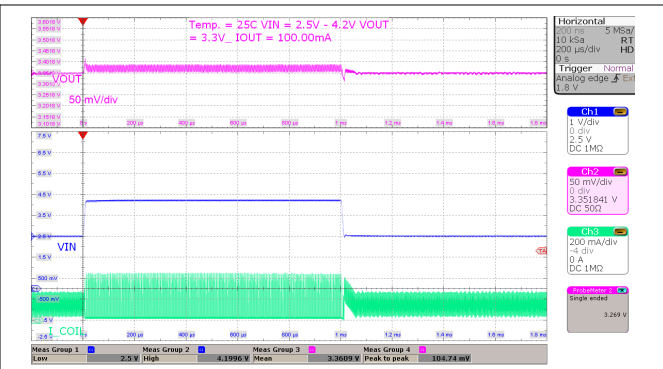

$V_I = 2.5\text{ V to }4.2\text{ V}$, $V_O = 3.3\text{ V}$ Load = 100 mA

Figure 8-21. Line Transient, High Load

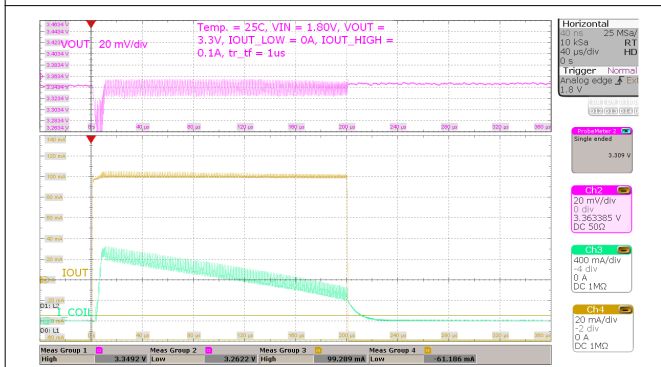

$V_I = 1.8\text{ V}$, $V_O = 3.3\text{ V}$ Load = 0 mA to 100 mA, $t_r/t_f = 1\ \mu\text{s}$

Figure 8-22. Load Transient, 100 mA Step

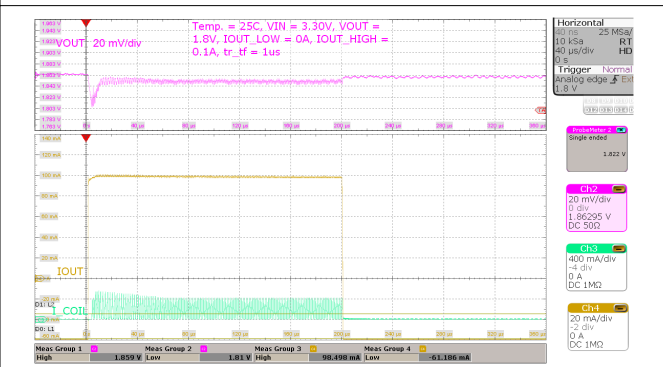

$V_I = 3.3\text{ V}$, $V_O = 1.8\text{ V}$ Load = 0 mA to 100 mA, $t_r/t_f = 1\ \mu\text{s}$

Figure 8-23. Load Transient, 100 mA Step

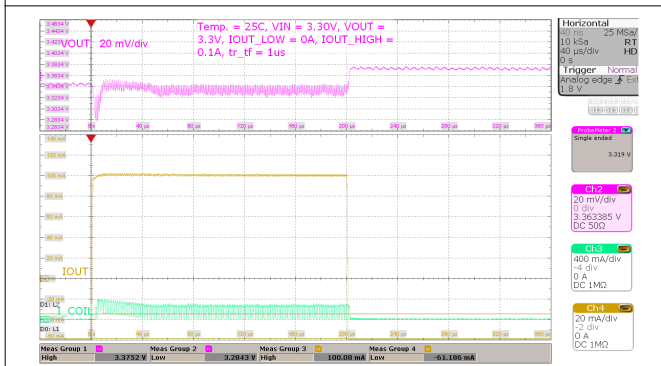

$V_I = 3.3\text{ V}$, $V_O = 3.3\text{ V}$ Load = 0 mA to 100 mA, $t_r/t_f = 1\ \mu\text{s}$

Figure 8-24. Load Transient, 100 mA Step

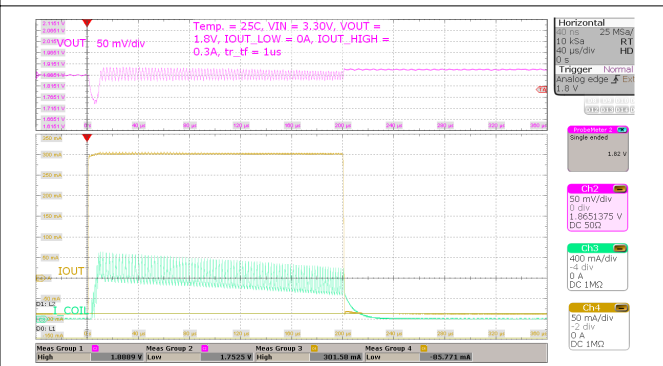

$V_I = 3.3\text{ V}$, $V_O = 1.8\text{ V}$ Load = 0 mA to 300 mA, $t_r/t_f = 1\ \mu\text{s}$

Figure 8-25. Load Transient, 300 mA Step

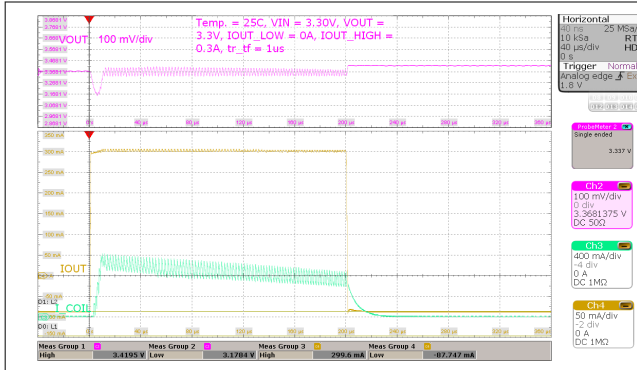

$V_I = 3.3\text{ V}$, $V_O = 3.3\text{ V}$ Load = 0 mA to 300 mA, $t_r/t_f = 1\ \mu\text{s}$

Figure 8-26. Load Transient, 300 mA Step

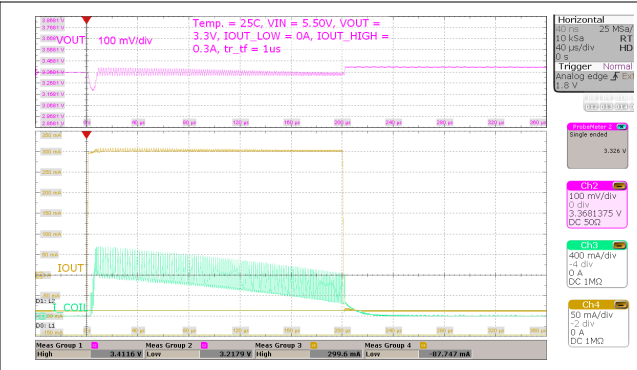

$V_I = 5.5\text{ V}$, $V_O = 3.3\text{ V}$ Load = 0 mA to 300 mA, $t_r/t_f = 1\ \mu\text{s}$

Figure 8-27. Load Transient, 300 mA Step

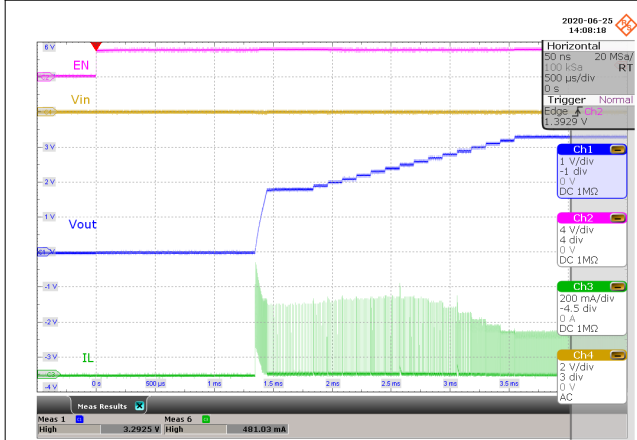

$V_I = 3.3\text{ V}$, $V_O = 3.3\text{ V}$ 100-mA resistive load

Figure 8-28. Start-up Behavior from Rising Enable

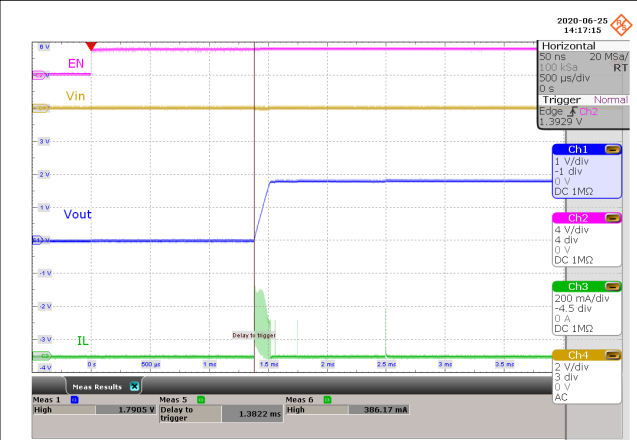

$V_I = 1.8\text{ V}$, $V_O = 1.8\text{ V}$ 10- μA resistive load

Figure 8-29. Start-up Behavior from Rising Enable

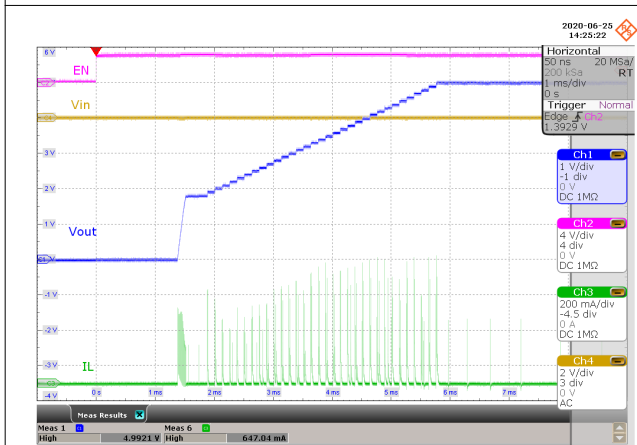

$V_I = 1.8\text{ V}$, $V_O = 5.0\text{ V}$ 10- μA resistive load

Figure 8-30. Start-up Behavior from Rising Enable

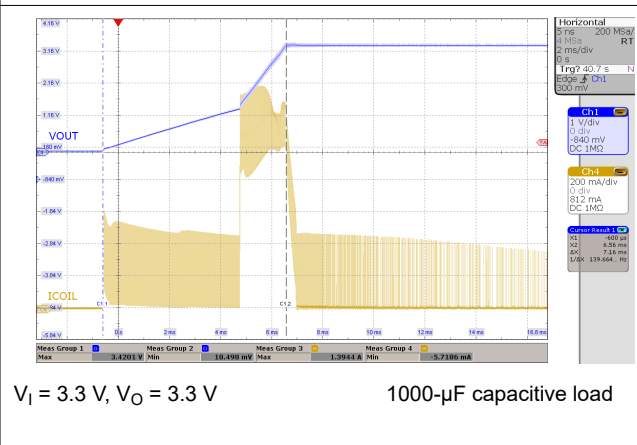

$V_I = 3.3\text{ V}$, $V_O = 3.3\text{ V}$ 1000- μF capacitive load

Figure 8-31. Start-up Behavior from Rising Enable

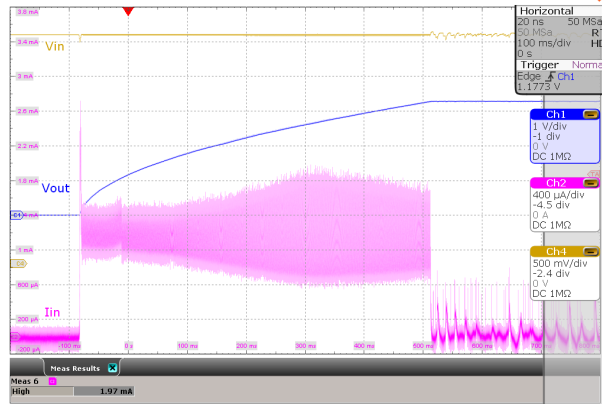

$V_I = 3.3\text{ V}, V_O = 3.3\text{ V}$ $C_I = 32\ \mu\text{F}, C_O = 300\ \mu\text{F}$

Figure 8-32. Start-up with 1-mA ICL

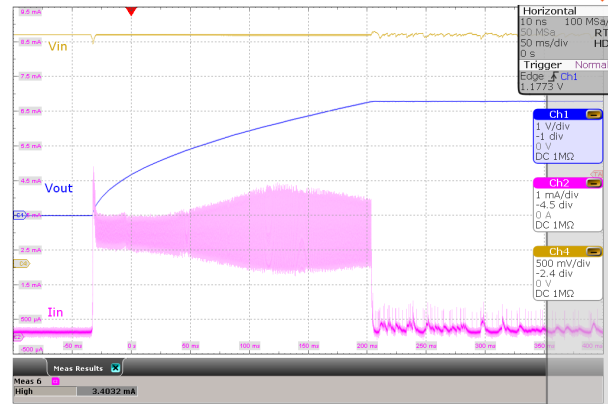

$V_I = 3.3\text{ V}, V_O = 3.3\text{ V}$ $C_I = 32\ \mu\text{F}, C_O = 300\ \mu\text{F}$

Figure 8-33. Start-up with 2.5-mA ICL

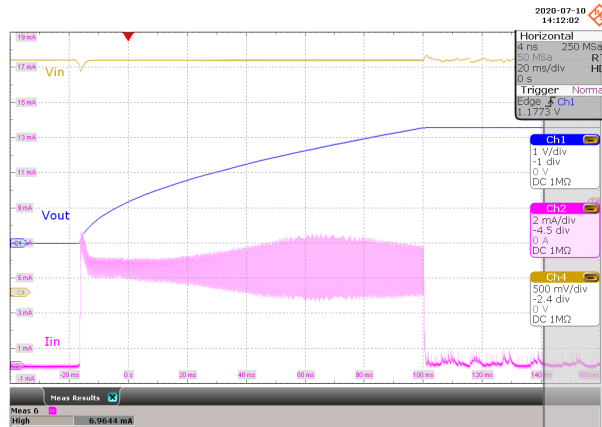

$V_I = 3.3\text{ V}, V_O = 3.3\text{ V}$ $C_I = 32\ \mu\text{F}, C_O = 300\ \mu\text{F}$

Figure 8-34. Start-up with 5-mA ICL

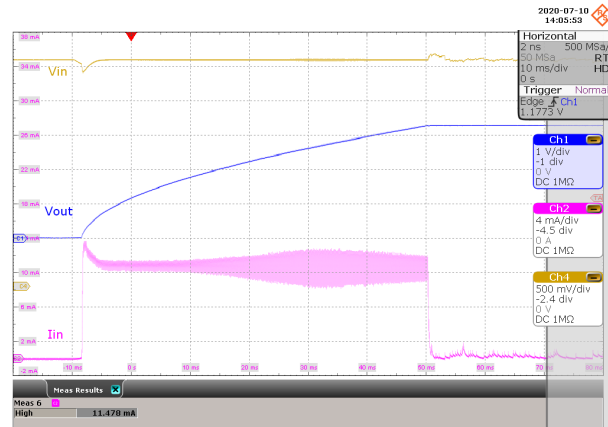

$V_I = 3.3\text{ V}, V_O = 3.3\text{ V}$ $C_I = 32\ \mu\text{F}, C_O = 300\ \mu\text{F}$

Figure 8-35. Start-up with 10-mA ICL

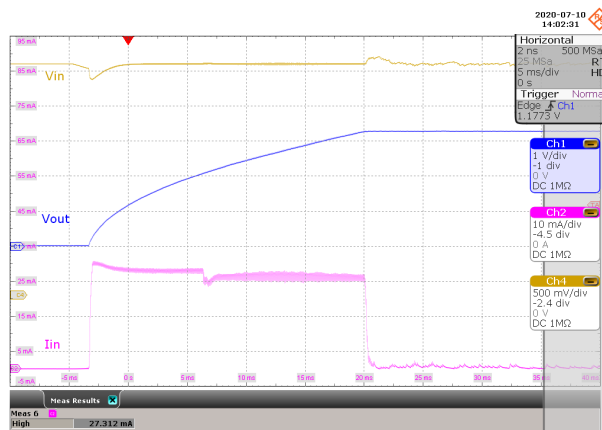

$V_I = 3.3\text{ V}, V_O = 3.3\text{ V}$ $C_I = 32\ \mu\text{F}, C_O = 300\ \mu\text{F}$

Figure 8-36. Start-up with 25-mA ICL

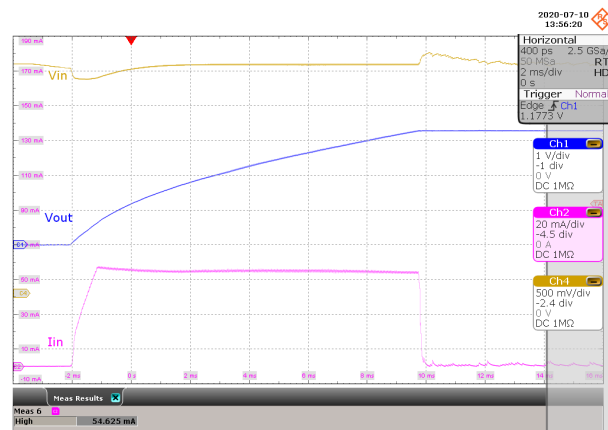

$V_I = 3.3\text{ V}, V_O = 3.3\text{ V}$ $C_I = 32\ \mu\text{F}, C_O = 300\ \mu\text{F}$

Figure 8-37. Start-up with 50-mA ICL

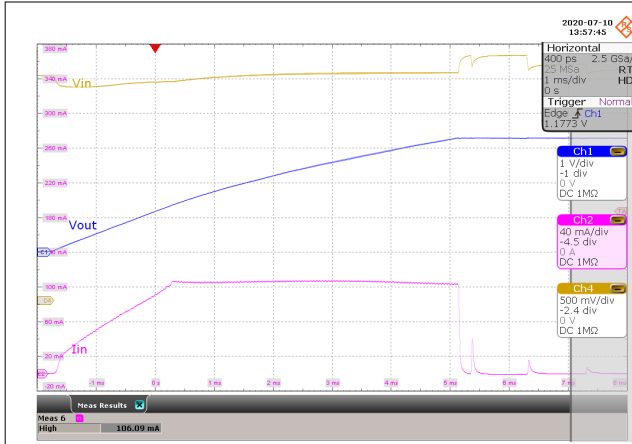

$V_I = 3.3\text{ V}, V_O = 3.3\text{ V}$ $C_I = 32\ \mu\text{F}, C_O = 300\ \mu\text{F}$

Figure 8-38. Start-up with 100-mA ICL

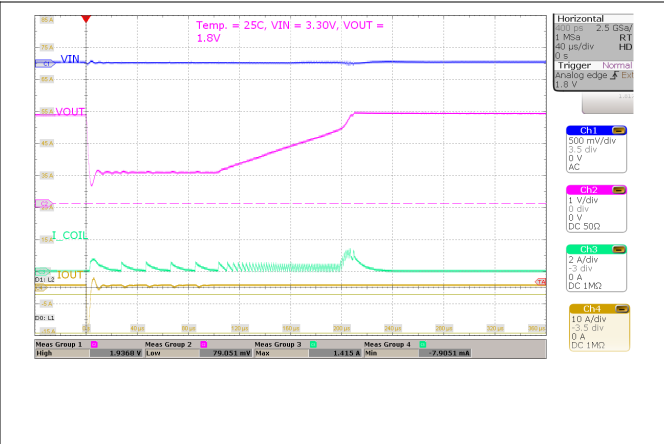

$V_I = 3.3\text{ V}, V_O = 1.8\text{ V}$ $T_A = 25^\circ\text{C}$

Figure 8-39. Short Circuit Behavior

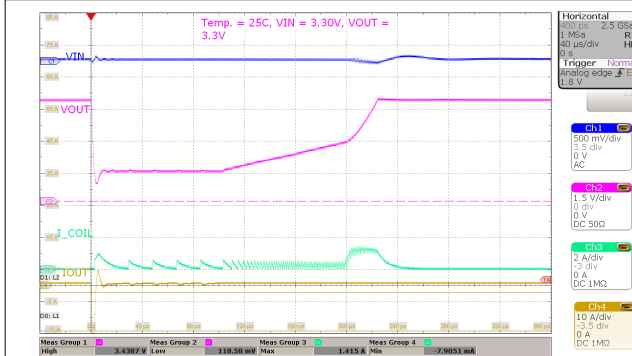

$V_I = 3.3\text{ V}, V_O = 3.3\text{ V}$ $T_A = 25^\circ\text{C}$

Figure 8-40. Short Circuit Behavior

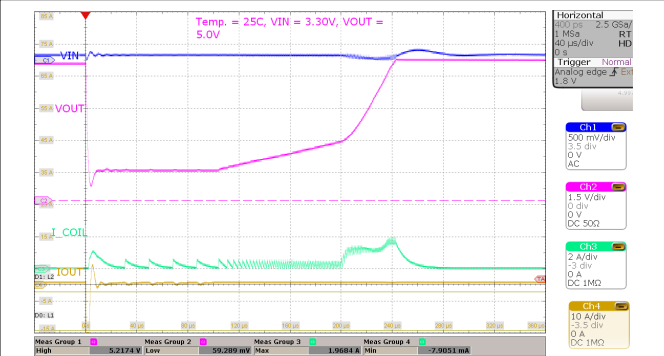

$V_I = 3.3\text{ V}, V_O = 5.0\text{ V}$ $T_A = 25^\circ\text{C}$

Figure 8-41. Short Circuit Behavior

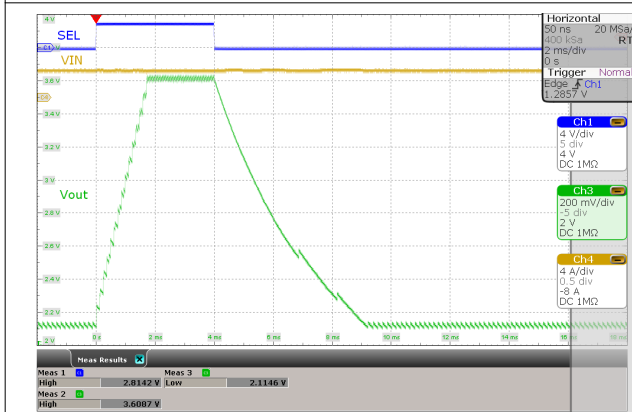

$V_I = 3.3\text{ V}, V_{O(1)} = 2.2\text{ V}, V_{O(2)} = 3.6\text{ V}$ 1-k Ω resistive load

Figure 8-42. DVS Behavior at Light Load

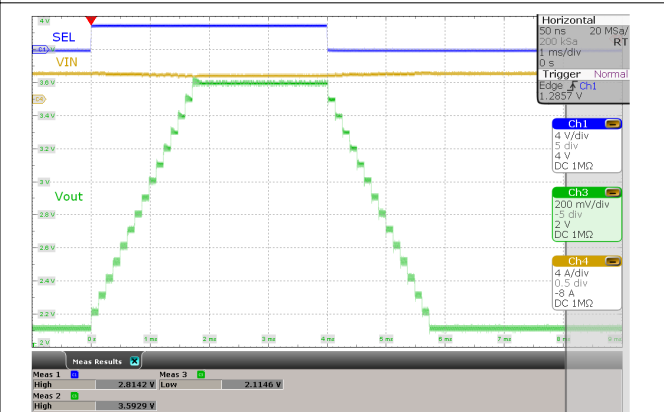

$V_I = 3.3\text{ V}, V_{O(1)} = 2.2\text{ V}, V_{O(2)} = 3.6\text{ V}$ 30- Ω resistive load

Figure 8-43. DVS Behavior at High Load

9 Power Supply Recommendations

The TPS63900 device is designed to operate with input supplies from 1.8 V to 5.5 V. The input supply must be stable and free of noise to achieve the full performance of the device. If the input supply is located more than a few centimeters away from the device, additional bulk capacitance can be required. The input capacitance shown in the application schematics in this data sheet is sufficient for typical applications.

10 Layout

10.1 Layout Guidelines

PCB layout is an important part of any switching power supply design. A poor layout can cause unstable operation, load regulation problems, increased ripple and noise, and EMI issues.

The following PCB layout design guidelines are recommended:

- Place the input and output capacitors close to the device.
- Minimize the area of the input loop, and use short, wide traces on the top layer to connect the input capacitor to the VIN and GND pins.
- Minimize the area of the output loop, and use short, wide traces on the top layer to connect the output capacitor to the VOUT and GND pins.
- The location of the inductor on the PCB is less important than the location of the input and output capacitors. Place the inductor after the input and output capacitors have been placed close to the device. You can route the traces to the inductor on an inner layer if necessary.

10.2 Layout Example

Figure 10-1 shows an example of a PCB layout that follows the recommendations of the previous section.

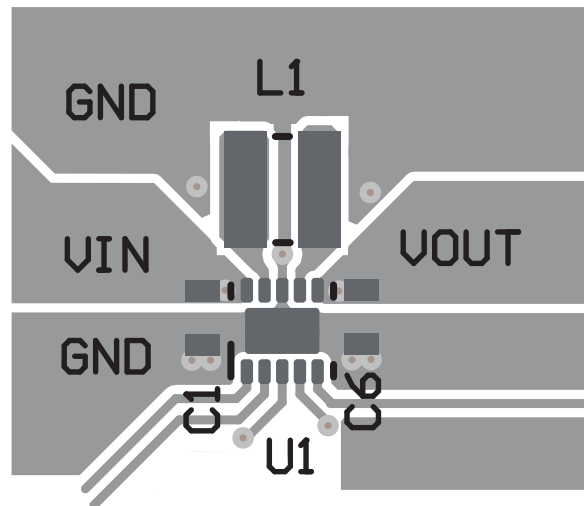

Figure 10-1. PCB Layout Example

11 Device and Documentation Support

11.1 Device Support

11.1.1 Third-Party Products Disclaimer

TI'S PUBLICATION OF INFORMATION REGARDING THIRD-PARTY PRODUCTS OR SERVICES DOES NOT CONSTITUTE AN ENDORSEMENT REGARDING THE SUITABILITY OF SUCH PRODUCTS OR SERVICES OR A WARRANTY, REPRESENTATION OR ENDORSEMENT OF SUCH PRODUCTS OR SERVICES, EITHER ALONE OR IN COMBINATION WITH ANY TI PRODUCT OR SERVICE.

11.2 Documentation Support

11.2.1 Related Documentation

For related documentation see the following:

Texas Instruments, [TPS63900 EVM User Guide](#)

11.3 Receiving Notification of Documentation Updates

To receive notification of documentation updates, navigate to the device product folder on [ti.com](#). Click on *Subscribe to updates* to register and receive a weekly digest of any product information that has changed. For change details, review the revision history included in any revised document.

11.4 Support Resources

[TI E2E™ support forums](#) are an engineer's go-to source for fast, verified answers and design help — straight from the experts. Search existing answers or ask your own question to get the quick design help you need.

Linked content is provided "AS IS" by the respective contributors. They do not constitute TI specifications and do not necessarily reflect TI's views; see TI's [Terms of Use](#).

11.5 Trademarks

TI E2E™ is a trademark of Texas Instruments.

WEBENCH® is a registered trademark of Texas Instruments.

All trademarks are the property of their respective owners.

11.6 Electrostatic Discharge Caution



This integrated circuit can be damaged by ESD. Texas Instruments recommends that all integrated circuits be handled with appropriate precautions. Failure to observe proper handling and installation procedures can cause damage.

ESD damage can range from subtle performance degradation to complete device failure. Precision integrated circuits may be more susceptible to damage because very small parametric changes could cause the device not to meet its published specifications.

11.7 Glossary

[TI Glossary](#) This glossary lists and explains terms, acronyms, and definitions.

12 Mechanical, Packaging, and Orderable Information

The following pages include mechanical, packaging, and orderable information. This information is the most current data available for the designated devices. This data is subject to change without notice and revision of this document. For browser-based versions of this data sheet, refer to the left-hand navigation.

PACKAGING INFORMATION

Orderable Device	Status (1)	Package Type	Package Drawing	Pins	Package Qty	Eco Plan (2)	Lead finish/ Ball material (6)	MSL Peak Temp (3)	Op Temp (°C)	Device Marking (4/5)	Samples
TPS63900DSKR	ACTIVE	SON	DSK	10	3000	RoHS & Green	NIPDAU	Level-1-260C-UNLIM	-40 to 125	639	Samples

(1) The marketing status values are defined as follows:

ACTIVE: Product device recommended for new designs.

LIFEBUY: TI has announced that the device will be discontinued, and a lifetime-buy period is in effect.

NRND: Not recommended for new designs. Device is in production to support existing customers, but TI does not recommend using this part in a new design.

PREVIEW: Device has been announced but is not in production. Samples may or may not be available.

OBSOLETE: TI has discontinued the production of the device.

(2) **RoHS:** TI defines "RoHS" to mean semiconductor products that are compliant with the current EU RoHS requirements for all 10 RoHS substances, including the requirement that RoHS substance do not exceed 0.1% by weight in homogeneous materials. Where designed to be soldered at high temperatures, "RoHS" products are suitable for use in specified lead-free processes. TI may reference these types of products as "Pb-Free".

RoHS Exempt: TI defines "RoHS Exempt" to mean products that contain lead but are compliant with EU RoHS pursuant to a specific EU RoHS exemption.

Green: TI defines "Green" to mean the content of Chlorine (Cl) and Bromine (Br) based flame retardants meet JS709B low halogen requirements of <=1000ppm threshold. Antimony trioxide based flame retardants must also meet the <=1000ppm threshold requirement.

(3) MSL, Peak Temp. - The Moisture Sensitivity Level rating according to the JEDEC industry standard classifications, and peak solder temperature.

(4) There may be additional marking, which relates to the logo, the lot trace code information, or the environmental category on the device.

(5) Multiple Device Markings will be inside parentheses. Only one Device Marking contained in parentheses and separated by a "-" will appear on a device. If a line is indented then it is a continuation of the previous line and the two combined represent the entire Device Marking for that device.

(6) Lead finish/Ball material - Orderable Devices may have multiple material finish options. Finish options are separated by a vertical ruled line. Lead finish/Ball material values may wrap to two lines if the finish value exceeds the maximum column width.

Important Information and Disclaimer:The information provided on this page represents TI's knowledge and belief as of the date that it is provided. TI bases its knowledge and belief on information provided by third parties, and makes no representation or warranty as to the accuracy of such information. Efforts are underway to better integrate information from third parties. TI has taken and continues to take reasonable steps to provide representative and accurate information but may not have conducted destructive testing or chemical analysis on incoming materials and chemicals. TI and TI suppliers consider certain information to be proprietary, and thus CAS numbers and other limited information may not be available for release.

In no event shall TI's liability arising out of such information exceed the total purchase price of the TI part(s) at issue in this document sold by TI to Customer on an annual basis.

TAPE AND REEL INFORMATION



QUADRANT ASSIGNMENTS FOR PIN 1 ORIENTATION IN TAPE



*All dimensions are nominal

Device	Package Type	Package Drawing	Pins	SPQ	Reel Diameter (mm)	Reel Width W1 (mm)	A0 (mm)	B0 (mm)	K0 (mm)	P1 (mm)	W (mm)	Pin1 Quadrant
TPS63900DSKR	SON	DSK	10	3000	180.0	8.4	2.8	2.8	1.0	4.0	8.0	Q2

TAPE AND REEL BOX DIMENSIONS



*All dimensions are nominal

Device	Package Type	Package Drawing	Pins	SPQ	Length (mm)	Width (mm)	Height (mm)
TPS63900DSKR	SON	DSK	10	3000	210.0	185.0	35.0

GENERIC PACKAGE VIEW

DSK 10

WSON - 0.8 mm max height

2.5 x 2.5 mm, 0.5 mm pitch

PLASTIC SMALL OUTLINE - NO LEAD

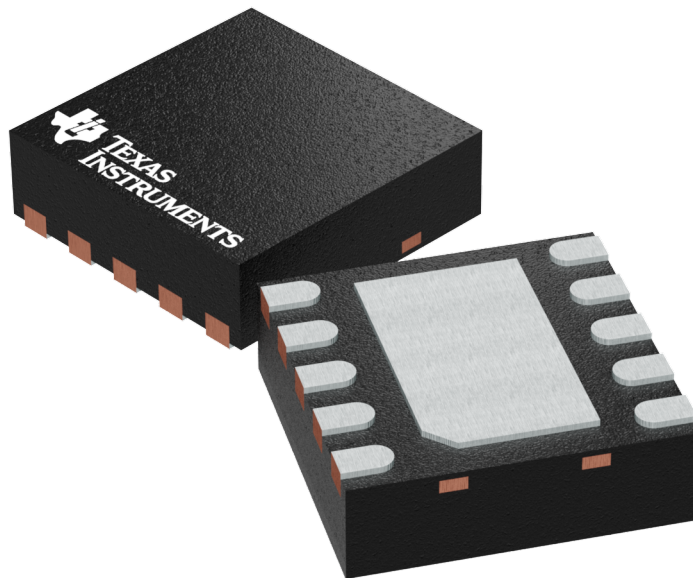

Images above are just a representation of the package family, actual package may vary.
Refer to the product data sheet for package details.

4225304/A

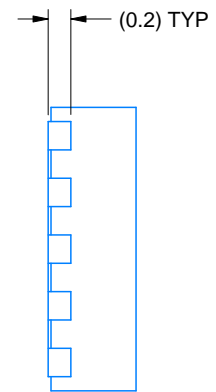
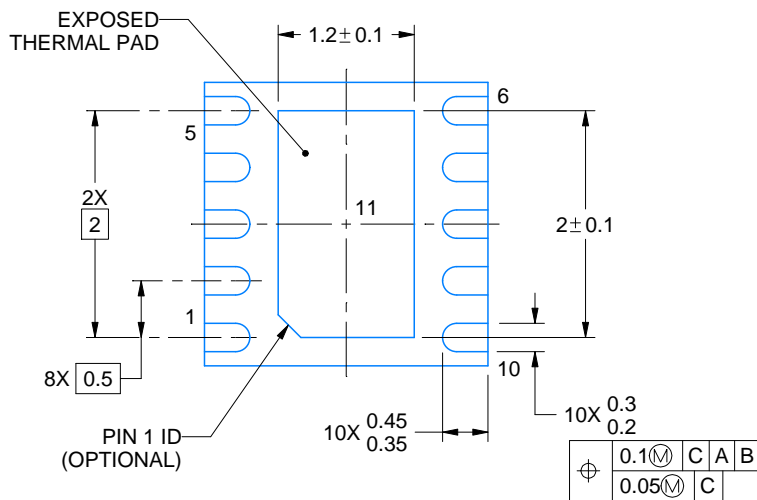
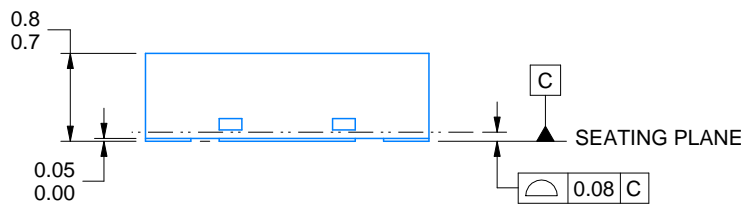
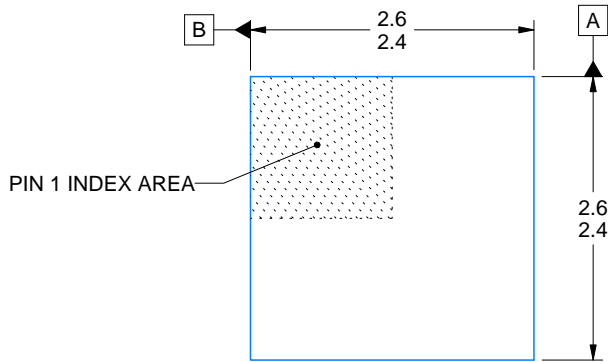
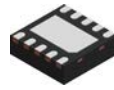

4218903/B 10/2020

NOTES:

1. All linear dimensions are in millimeters. Any dimensions in parenthesis are for reference only. Dimensioning and tolerancing per ASME Y14.5M.
2. This drawing is subject to change without notice.
3. The package thermal pad must be soldered to the printed circuit board for thermal and mechanical performance.

EXAMPLE BOARD LAYOUT

DSK0010A

WSON - 0.8 mm max height

PLASTIC SMALL OUTLINE - NO LEAD

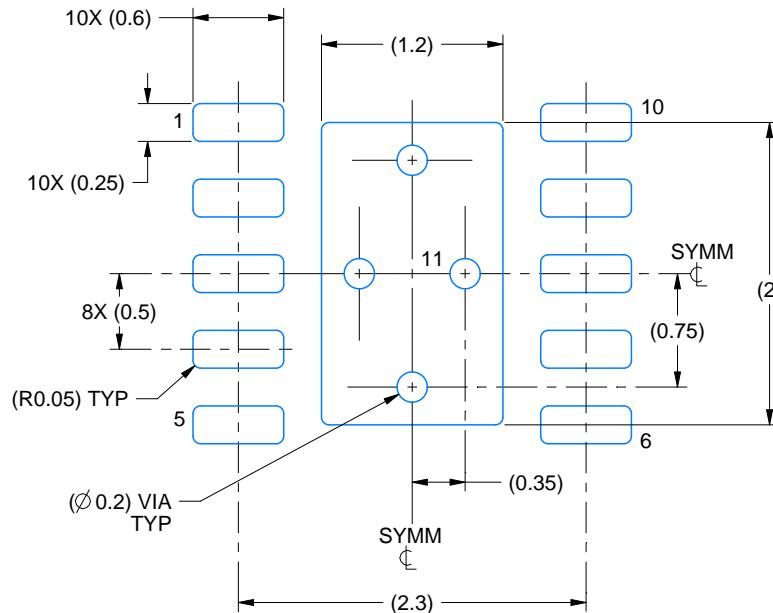

LAND PATTERN EXAMPLE
SCALE:20X

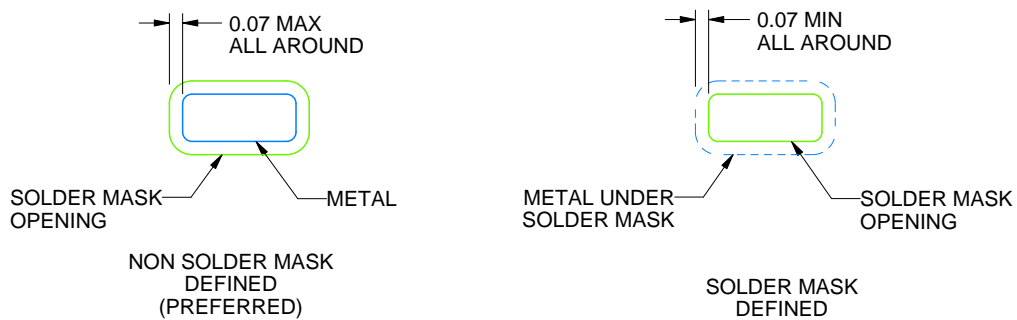

SOLDER MASK DETAILS

4218903/B 10/2020

NOTES: (continued)

4. This package is designed to be soldered to a thermal pad on the board. For more information, see Texas Instruments literature number SLUA271 (www.ti.com/lit/slue271).
5. Vias are optional depending on application, refer to device data sheet. If some or all are implemented, recommended via locations are shown.

EXAMPLE STENCIL DESIGN

DSK0010A

WSON - 0.8 mm max height

PLASTIC SMALL OUTLINE - NO LEAD

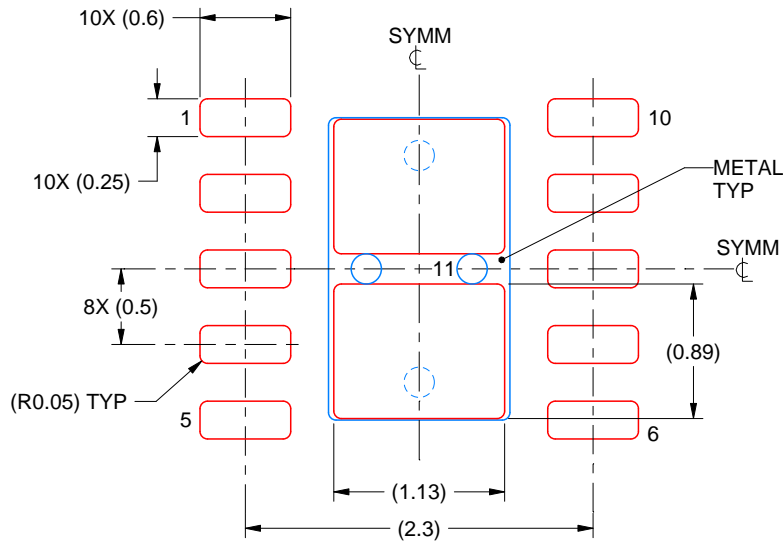

SOLDER PASTE EXAMPLE
BASED ON 0.125 mm THICK STENCIL

EXPOSED PAD 11
84% PRINTED SOLDER COVERAGE BY AREA
SCALE:20X

4218903/B 10/2020

NOTES: (continued)

6. Laser cutting apertures with trapezoidal walls and rounded corners may offer better paste release. IPC-7525 may have alternate design recommendations.

IMPORTANT NOTICE AND DISCLAIMER

TI PROVIDES TECHNICAL AND RELIABILITY DATA (INCLUDING DATASHEETS), DESIGN RESOURCES (INCLUDING REFERENCE DESIGNS), APPLICATION OR OTHER DESIGN ADVICE, WEB TOOLS, SAFETY INFORMATION, AND OTHER RESOURCES "AS IS" AND WITH ALL FAULTS, AND DISCLAIMS ALL WARRANTIES, EXPRESS AND IMPLIED, INCLUDING WITHOUT LIMITATION ANY IMPLIED WARRANTIES OF MERCHANTABILITY, FITNESS FOR A PARTICULAR PURPOSE OR NON-INFRINGEMENT OF THIRD PARTY INTELLECTUAL PROPERTY RIGHTS.

These resources are intended for skilled developers designing with TI products. You are solely responsible for (1) selecting the appropriate TI products for your application, (2) designing, validating and testing your application, and (3) ensuring your application meets applicable standards, and any other safety, security, or other requirements. These resources are subject to change without notice. TI grants you permission to use these resources only for development of an application that uses the TI products described in the resource. Other reproduction and display of these resources is prohibited. No license is granted to any other TI intellectual property right or to any third party intellectual property right. TI disclaims responsibility for, and you will fully indemnify TI and its representatives against, any claims, damages, costs, losses, and liabilities arising out of your use of these resources.

TI's products are provided subject to TI's Terms of Sale (<https://www.ti.com/legal/termsofsale.html>) or other applicable terms available either on [ti.com](https://www.ti.com) or provided in conjunction with such TI products. TI's provision of these resources does not expand or otherwise alter TI's applicable warranties or warranty disclaimers for TI products.

Mailing Address: Texas Instruments, Post Office Box 655303, Dallas, Texas 75265
Copyright © 2021, Texas Instruments Incorporated