

# **T-Rad<sup>®</sup> and nu-Trac<sup>®</sup>** **High Performance Radiating Cable**



## ***Radiating Cable Solutions for Interior RF Communications and Security Applications***

- ***Mines***
- ***Tunnels***
- ***Ships***
- ***Subways***
- ***In-Building***
- ***Oil Rig Platforms***
- ***Perimeter Detection***

***Introduction:***

Times Microwave Systems offers TRAD™ and NuTrac™ radiating cables to provide RF coverage in structures which are otherwise difficult to cover. Conventional examples include rail and transit tunnels, underground mines, subways, metal-hulled ships, offshore oil rigs, nuclear power plants and buildings with metal supporting structures.

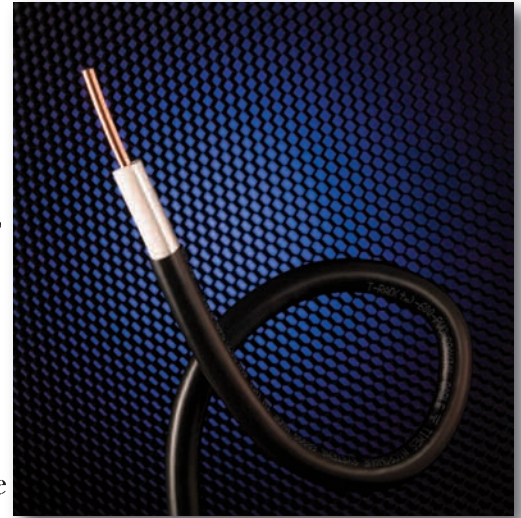

Multi-point, antenna based communications systems are unable to provide uniform RF coverage. In order to provide adequate coverage, many service providers increase the power levels to unacceptable levels. This problem can be overcome with the use of radiating cables instead of point source antennas. These cables act as continuous antennas, and are designed to emit RF signals at very low power levels. These low power levels reduce the potential for interference with other nearby systems using the same frequencies and allow for frequency reuse. Examples are the creation of mini-cells within a building and low-level roadside AM broadcast systems.

Other advantages of radiating cables are their ability to carry multiple frequencies on a single cable, and to function as a single broadband antenna. The radio frequency signals are fed between the transmitter and antenna and a controlled amount of energy is leaked into the surrounding environment which provides the needed RF coverage. The radiating cable is designed to both receive and transmit RF signals in the surrounding controlled environment across this single broadband antenna cable.

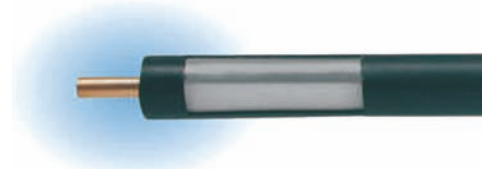

***T-RAD Leaky Feeder Cable:***

Times Microwave offers the T-RAD series of flexible, low-loss leaky feeder cables. This design provides a cost effective solution where point source antennas are not practical. The T-RAD cables utilize a continuous single slot design, which is achieved by bonding a metalized shield to the low-loss foamed polyethylene core. This foamed core/shield design yields a very flexible lightweight design, which allows for easy installation. The slot opening is designed to provide a balance between down-line signal attenuation and coupling loss. It's broadband design allows it to be used from lower frequency AM/FM radio rebroadcast through the higher frequency 802.11 WLAN applications.

There are currently two different jacket versions available with the T-RAD cables. The standard T-RAD cable utilizes a flexible PVC outer jacket while the T-RAD-FR series utilizes a non-halogen, low-smoke flame retardant jacket. Both designs exhibit excellent flexibility, and provide very cost effective installation methods.

A wide range of connector styles are available for the T-RAD cables. The T-RAD-400 and -600 sizes were designed to accept the Times LMR EZ-style crimp connectors. A special thinner crimp ring is required to properly crimp the outer ring to the connector body. Reference the section for proper connector attachment procedures. For the T-RAD-900 size, the standard LMR EZ style clamp connectors are used.

# nu-TRAC<sup>®</sup>

## *nu-TRAC Radiating Cable:*

Times Microwave also offers the nuTRAC radiating cable series to address applications where longer runs of cable are required. Typical applications are long road tunnels, metros and subway systems. The nuTRAC series of cables are larger cables that offer lower down-line signal attenuation while still providing adequate RF coverage within the surrounding environment. This delicate balance of attenuation and coupling loss is achieved by the isolated overlapping shields that are separated by a thin polyethylene interlayer. The coupling mechanism between the inner and outer shields provide for controlled RF coverage. This transfer of energy between the two shields results in a design that exhibits relatively little sensitivity to the surrounding environment and its mounting effects. This design feature provides for a cable that is easier to install and reduces the concerns of mounting which results in an overall lower cable installation cost.

Times offers two jacket options for the nuTRAC series. For applications that do not require flame performance the standard nuTRAC is used, which employs a UV resistant polyethylene jacket. For applications that require flame performance, the nuTRAC-FR series would be used. The outer jacket on the -FR cables is a non-halogen, low-smoke and flame retardant polyolefin material. Many metro and subway applications require the use of non-halogen materials, as well as providing higher levels of flame performance.



### *Tunnels/Rail-Transit:*

Times Microwave supplies both the nuTRAC and T-RAD-600 cables for a wide variety of tunnel applications. The T-RAD-600 cable has been used to provide communications for the PATH rail tunnels at the World Trade Center site in New York City. T-RAD-600 is used as a backbone to provide radio frequency coverage throughout the mile long rail tunnels between New Jersey and lower Manhattan. A cascaded amplifier system offsets the attenuation and coupling losses, which are characteristics of all leaky feeder systems. The nuTRAC series has been used extensively in the New York City subway system to provide police radio coverage, in the London Underground system to provide a wide range of RF coverage and in the Moscow and St. Petersburg metro system's to provide Tetra, GSM900 and UMTS coverage.



### *In-Building Communications*

T-RAD-600 cable successfully provides broadband coverage in building applications for VHF, UHF, cellular, PCS and 802.11b WLAN frequencies. Typically this cable is run through a building, where point source antennas are not practical. The T-RAD's flexible lightweight design allows it to be routed easily for quicker and more cost effective installation. With the use of cross-band couplers a single T-RAD cable backbone can support multiple use frequencies. In addition to in-building applications, the cable has been utilized by many utilities to provide broadband RF coverage.

### *Offshore Oil-Rigs:*

Times Microwave has supplied the T-RAD-600FR series to the offshore oil-rig industry. The multi-deck layout of many oil rigs combined with many shadowed areas, creates a difficult environment in which to obtain consistent radio frequency coverage with single point antennas. T-RAD cables have been utilized to provide deck to deck broadband RF communications coverage, and elevate coverage in the dead spots which are common in such an environment. The jacket material used on the -FR series cables is a flame-retardant, non-halogen, low-smoke material, that provides an increased level of safety, which is always a concern for offshore applications.



### *Mining:*

T-RAD-600 leaky feeder cables are used to provide underground communications for a wide variety of mining applications. The cable is run throughout the mining tunnels and allows a controlled amount of signal to leak into the surrounding environment. This enables the cable to receive and transmit, where radio frequency coverage is required. T-RAD cable can be run into splitters, providing a means to run leaky feeder cable into any shadowed or cross-tunnel areas. Times maintains MSHA mining approvals for both its T-RAD-FR (MSHA Approval #07-KA070009P) leaky feeder cables, as well as its LMR-FR (MSHA Approval #07-KA070010P) series of low-loss coaxial cables.

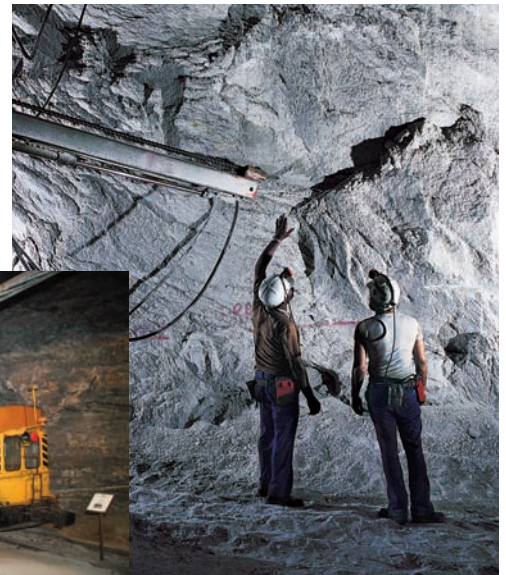

### *Perimeter Detection Systems:*

Times Microwave supplies T-RAD-600DB cable for direct burial detection system applications. This cable provides coverage around highly sensitive areas that require added security, such as prisons, nuclear facilities and military installations. The T-RAD cable radiates a signal creating an EMF field, which when disturbed by an intrusion alerts security personnel. The added water-blocking material and dual jacketed outer polyethylene jacket of the DB series, allows this cable to be directly buried where perimeter routing is required. This application provides an undetectable RF perimeter around the monitored location.



### *Commercial and Military Shipbuilding:*

Much like the offshore oil-rig applications, many of the same coverage issues that plague RF designers are also found in shipbuilding applications. Many large vessels have multi-deck designs, with many enclosed stairwells and shadowed areas. With the use of the T-RAD and nuTRAC designs, RF engineers can design a layout to provide the needed radio coverage aboard ship. From relatively low frequency VHF applications to applications where 2.4 GHz WiFi coverage is need, these cables can offer broadband controlled RF coverage.



# T-RAD™-400

## 50 Ohm Leaky Feeder Coaxial Cable

- Provides RF coverage in buildings, mines and other enclosed areas
- Offers broadband performance up to 2.5 GHz
- Flexible, non-kinking design provides easier installation
- Accepts standard "EZ" crimp connectors used for LMR-400 cable\*
- FR series is MSHA approved for mining applications



Part Description				
Part Number	Application	Jacket	Color	Stock Code
AA-9300	T-RAD-400-PVC	PVC	Black	44043
AA-11399	T-RAD-400-FR	FRPE	Black	44053

Physical & Mechanical Specifications		
	in	(mm)
Inner Conductor: Solid BCCAl	0.108	(2.74)
Dielectric: Gas-Injected Foam Polyethylene	0.285	(7.24)
Inner Shield: Bonded Aluminum Tape	0.291	(7.39)
Jacket: Extruded PVC or FR	0.350	(8.89)
Bend Radius: Installation	1.0	(38)
Bend Radius: Repeated	4.0	(152.4)
Weight: Extruded PVC or FR	0.05 lbs./ft	(0.076 kg/m)
Operating Temperature Range	-40°/+185°F	-40°/+85°C

Electrical Specifications				
Velocity of Propagation		85%		
Dielectric Constant		1.38		
Time Delay		1.20 nS/ft	(3.94 nS/m)	
Impedance		50 ohms		
Voltage Withstand		2500 Volts DC		
Jacket Spark		5000 Volts RMS		
Attenuation	(MHz)	dB/100 ft	dB/100 m	Coupling Loss*
	150	2.30	7.55	54
	450	4.00	13.2	65
	900	5.90	19.40	68
	1900	8.80	28.9	68
	2400	10.00	33.5	67

## T-RAD™-400 Loss & Coupling vs Frequency

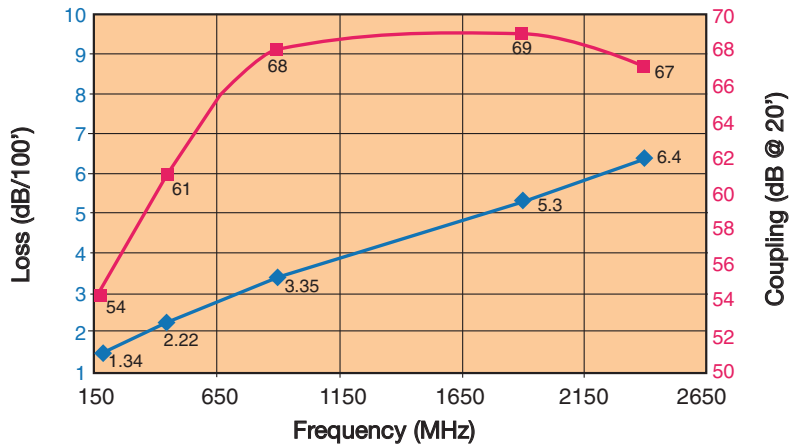

## T-RAD™-400 Comparison

T-RAD-400 -vs- Corrugated Copper			
	1/4" CC	T-RAD-400	3/8" CC
Overall Diameter (in)	0.350"	0.350"	0.460"
Insertion Loss/Coupling Loss			
150 MHz	2.70/58	2.30/54	1.5/56
450 MHz	5.1/62	4.00/65	2.6/61
900 MHz	7.1/69	5.90/68	3.7/68
1700 MHz	9.7/71	8.50/68	5.3/74
2400 MHz	13.5/70	10.0/67	7.0/73



*Special crimp ring part number  
3192-164 (TR-400) must be  
used on all EZ style connectors*

Connectors											
Interface	Description	Part Number	Stock Code	VSWR* Freq. (GHZ)	Coupling Nut	Inner Contact Attachment	Outer Contact Attachment	Finish* Body/Pin	Length in (mm)	Width in (mm)	Weight lb (g)
7-16 DIN Male	Straight Plug	EZ-400-716M-X	3190-2524	<1.25:1 (6)	Hex	Spring Finger	Crimp	A/G	1.6 (39.5)	1.38 (35)	0.277 (126.0)
UHF Male	Straight Plug	EZ-400-UM	3190-997	<1.25:1 (2.5)	Knurl	Spring Finger	Crimp	N/G	1.8 (48)	0.80 (20.3)	0.076 (34.4)
N Female	Straight Jack	EZ-400-NF-X	3190-2818	<1.25:1 (2.5)	NA	Spring Finger	Crimp	N/G	1.8 (45)	0.66 (16.8)	0.105 (47.6)
N Female	Bulkhead Jack	EZ-400-NF-BH	3190-518	<1.25:1 (2.5)	NA	Spring Finger	Crimp	N/G	1.8 (46)	0.88 (22.4)	0.102 (46.3)
N Male	Straight Plug	EZ-400-NMH-X	3190-2590	<1.25:1 (10)	Hex/Knurl	Spring Finger	Crimp	A/G	1.5 (38)	0.89 (22.6)	0.103 (46.8)
N Male	Right Angle	EZ-400-NMH-RA-X	3190-2638	<1.35:1 (6)	Hex/Knurl	Spring Finger	Crimp	A/G	1.87 (47)	1.42 (36.0)	0.177 (80.2)
TNC Male	Reverse Polarity	EZ-400-TF-RP	3190-795	<1.25:1 (2.5)	NA	Spring Finger	Crimp	A/G	1.8 (46)	0.55 (14.0)	0.074 (33.6)
TNC Male	Straight Plug	EZ-400-TM-X	3190-2533	<1.25:1 (6)	Hex/Knurl	Spring Finger	Crimp	A/G	1.9 (48)	0.67 (17.5)	0.075 (34.3)
TNC Male	Reverse Polarity	EZ-400-TM-RP	3190-794	<1.25:1 (2.5)	Knurl	Spring Finger	Crimp	A/G	1.7 (43)	0.59 (15.0)	0.074 (33.6)

# T-RAD™-600

## 50 Ohm Leaky Feeder Coaxial Cable

- Provides RF coverage in buildings, mines and other enclosed areas
- Offers broadband performance up to 2.5 GHz
- Flexible, non-kinking design provides easier installation
- Accepts standard "EZ" crimp connectors used for LMR-600 cable\*
- FR series is MSHA approved for mining applications



Part Description				
Part Number	Application	Jacket	Color	Stock Code
AA-9096	T-RAD-600-PVC	PVC	Black	44030
AA-9097	T-RAD-600-FR	FRPE	Black	44031
AA-9299	T-RAD-600-DB	PVC/PE	Black	44038

Physical & Mechanical Specifications		
	in	(mm)
Inner Conductor: Solid BCCA1	0.176	(4.47)
Dielectric: Gas-Injected Foam Polyethylene	0.455	(11.56)
Inner Shield: Bonded Aluminum Tape	0.458	(11.63)
Jacket: Extruded PVC or FR	0.530	(13.46)
DB Version PVC/PE	0.590	(14.98)
Bend Radius: Installation	1.5	(38)
Bend Radius: Repeated	6.0	(152.4)
Weight: Extruded PVC or FR	0.09 lbs./ft	(0.137 kg/m)
DB Version PVC/PE	0.14 lbs./ft	(0.213 kg/m)
Operating Temperature Range	-40°/+185°F	-40°/+85°C

Electrical Specifications				
Velocity of Propagation	86%			
Dielectric Constant	1.35			
Time Delay	1.18 nS/ft (3.87 nS/m)			
Impedance	50 ohms			
Voltage Withstand	4000 Volts DC			
Jacket Spark	6000 Volts RMS			
Attenuation	(MHz)	dB/100 ft	dB/100 m	Coupling Loss*
	150	1.34	4.39	54
	450	2.22	7.28	61
	900	3.35	10.98	68
	1900	5.30	17.38	69
	2400	6.40	20.99	67



## T-RAD™-600 Loss & Coupling vs Frequency

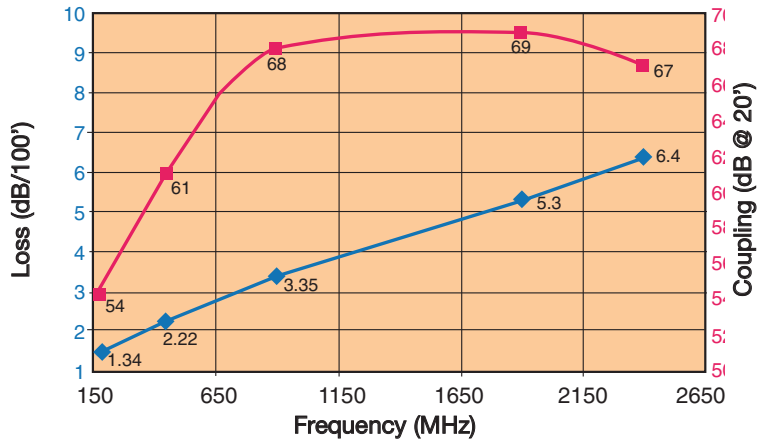

## T-RAD™-600 Comparison

T-RAD-600 -vs- Corrugated Copper			
	3/8" CC	T-RAD-600	1/2" CC
Overall Diameter (in)	0.460"	0.520"	0.650"
Insertion Loss/Coupling Loss			
150 MHz	1.5/56	1.3/54	1.0/58
450 MHz	2.6/61	2.2/61	2.0/63
900 MHz	3.7/68	3.4/69	2.9/68
1700 MHz	5.3/74	5.3/72	4.0/73
2400 MHz	7.0/73	6.4/67	5.0/73



Connectors											
Interface	Description	Part Number	Stock Code	VSWR* Freq. (GHz)	Coupling Nut	Inner Contact Attachment	Outer Contact Attachment	Finish* Body/Pin	Length in (mm)	Width in (mm)	Weight lb (g)
N Male	Straight Plug	EZ-600-NMH-X	3190-2627	<1.25:1 (2.5)	Hex/Knurl	Spring Finger	Crimp	SG	2.1 (53)	0.92 (23.4)	1.164 (74.4)
N Male	Right Angle	EZ-600-NMH-RA-X	3190-2639	<1.25:1 (6)	Hex	Spring Finger	Crimp	SG	2.1 (53)	0.92 (23.4)	0.185 (83.9)
N Female	Straight Jack	EZ-600-NF	3190-2817	<1.25:1 (2.5)	NA	Spring Finger	Crimp	SG	2.3 (59)	0.87 (22.1)	0.150 (68.0)
N Female	Bulkhead Jack	EZ-600-NF-BH	3190-616	<1.25:1 (2.5)	NA	Spring Finger	Crimp	SG	2.4 (61)	0.88 (22.4)	0.195 (88.5)
TNC Male	Straight Plug	EZ-600-TM-X	3190-2531	<1.25:1 (2.5)	Knurl	Spring Finger	Crimp	SG	1.7 (43)	0.59 (15.0)	0.112 (50.8)
TNC Male	Reverse Polarity	EZ-600-TM-RP	3190-796	<1.25:1 (2.5)	Knurl	Spring Finger	Crimp	AG	2.2 (56)	0.87 (22.0)	0.112 (50.8)
TNC Female	Reverse Polarity	EZ-600-TF-RP	3190-797	<1.25:1 (2.5)	NA	Spring Finger	Crimp	AG	2.3 (58)	0.87 (22.0)	0.100 (45.4)
UHF Male	Straight Plug	EZ-600-UM	3190-615	<1.25:1 (2.5)	Knurl	Spring Finger	Crimp	SG	1.7 (43)	0.88 (22.4)	0.164 (74.4)
7-16 DIN Male	Straight Plug	EZ-600-716M-X	3190-2643	<1.25:1 (2.5)	Hex	Spring Finger	Crimp	SS	2.0 (51)	1.30 (33.0)	0.254 (115.2)

# T-RAD™-900

## 50 Ohm Leaky Feeder Coaxial Cable

- Provides RF coverage in buildings, mines and other enclosed areas
- Offers broadband performance up to 2.5 GHz
- Flexible, non-kinking design provides easier installation
- Accepts standard "EZ" clamp style connectors used for LMR-900 cable
- FR series is MSHA approved for mining applications



Part Description				
Part Number	Application	Jacket	Color	Stock Code
AA-9298	T-RAD-900-PVC	PVC	Black	44042
AA-9630	T-RAD-900-FR	FRPE	Black	44046
Physical & Mechanical Specifications				
			in	(mm)
Inner Conductor: BC Tube			0.262	(6.65)
Dielectric: Gas-Injected Foam Polyethylene			0.680	(17.27)
Inner Shield: Bonded Aluminum Tape			0.686	(17.42)
Jacket: Extruded PVC or FR			0.870	(22.10)
Bend Radius: Installation			3.00	(76.2)
Bend Radius: Repeated			9.0	(0.40)
Weight:			0.266 lbs./ft	(0.40 kg/m)
Operating Temperature Range			-40°/+185°F	-40°/+85°C
Electrical Specifications				
Velocity of Propagation		86%		
Dielectric Constant		1.32		
Time Delay		1.17 nS/ft (3.83 nS/m)		
Impedance		50 ohms		
Voltage Withstand		5000 Volts DC		
Jacket Spark		8000 Volts RMS		
Attenuation	(MHz)	dB/100 ft	dB/100 m	Coupling Loss*
	150	0.88	2.89	58
	450	1.56	5.12	62
	900	2.27	7.44	69
	1900	3.3	10.8	72

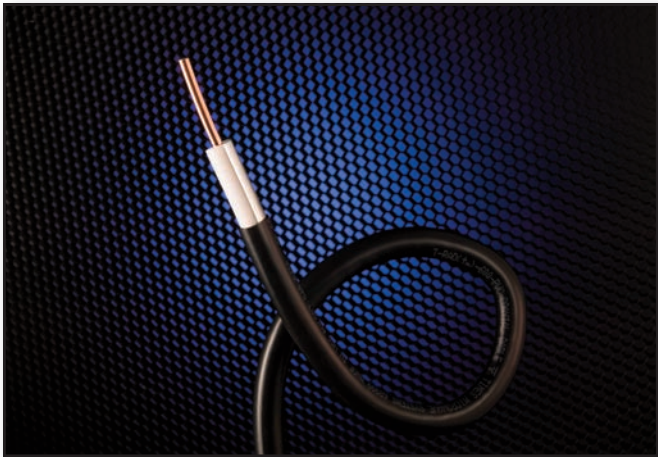

## T-RAD™-900 Loss & Coupling vs Frequency

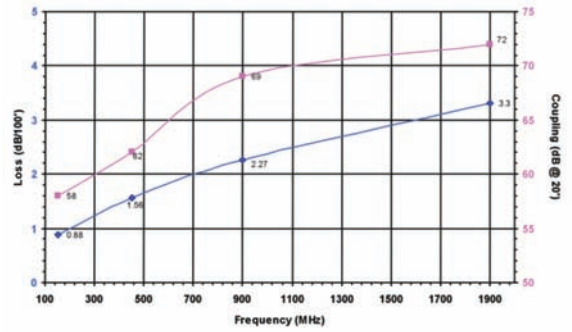

Connectors											
Interface	Description	Part Number	Stock Code	VSWR* Freq. (GHZ)	Coupling Nut	Inner Contact Attachment	Outer Contact Attachment	Finish* Body/Pin	Length in (mm)	Width in (mm)	Weight lb (g)
7-16 DIN Female	Straight Jack	EZ-900-716FC-2	3190-1550	<1.25:1 (2.5)	NA	Press Fit	Clamp	S/S	2.0 (51)	1.38 (35.1)	0.379 (171.9)
7-16 DIN Male	Straight Plug	EZ-900-716MC-2	3190-1641	1.25:1 (2.5)	Hex	Press Fit	Clamp	S/S	2.7 (69)	2.15 (55.0)	1.150 (521.6)
7-16 DIN Male	Right Angle	EZ-900-716MC-RA	3190-614	<1.35:1 (2.5)	Hex	Press Fit	Clamp	S/S	2.7 (69)	2.15 (55.0)	1.150 (521.6)
7/8 EIA	Straight Plug	EZ-900-78EIA-2	3190-1282	<1.25:1 (2.5)	NA	Press Fit	Clamp	S/S	3.0 (76)	2.24 (56.9)	1.013 (459.5)
N Male	Straight Plug	EZ-900-NMC-2	3190-1262	<1.25:1 (6)	Hex	Press Fi	Clamp	S/S	2.0 (51)	1.38 (35.1)	0.463 (210.0)
N Female	Straight Jack	EZ-900-NFC-2	3190-1263	<1.25:1 (6)	NA	Press Fit	Clamp	S/S	2.0 (51)	1.38 (35.1)	0.443 (200.9)

# nu-TRAC<sup>®</sup>

## TRC-875

- Provides interior communications in tunnels, subways, ships and metal framed buildings
- Offers stable electrical performance
- More flexible than corrugated designs
- No need for cable standoffs

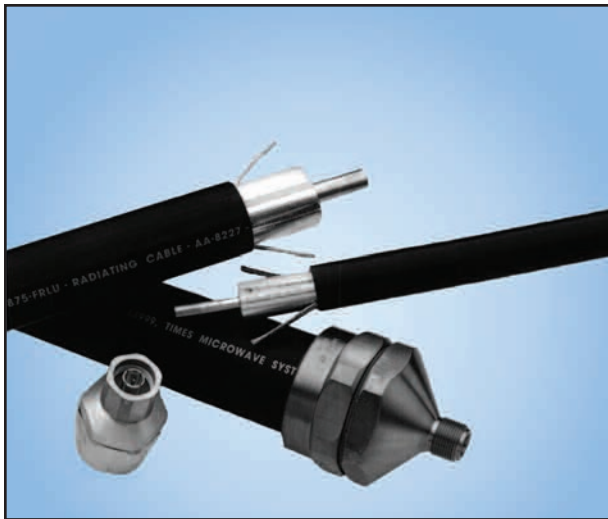

Electrical Specifications			
Performance Property	Units	US	Metric
Velocity of Propagation	%	86	
Impedance	Ohms	50	
VSWR, typical 150-900 MHz		1.2	
Coupling Loss	dB	@ 20 ft	
150 MHz		74	
450 MHz		80	
900 MHz		80	
1900 MHz		75	
2400MHz		74	
Attenuation	dB	/ 100 ft	/ 100 meters
150MHz		0.52	1.7
450MHz		0.98	3.2
900MHz		1.7	5.6
1900 MHz		2.9	9.5
2400MHz		3.3	10.8

Part Description	
Type No.	
<b>Cables</b>	
TRC 875-PE	- Polyethylene - outdoor version
TRC 875-VW1	- Non-halogen, fire retardant polyolefin
TRC 875-FR	- Highly fire retardant non-halogen polyolefin
<b>Connectors</b>	
TRB 875-NF	- "N" female connector 3190-2936
TRB 875-NM	- "N" male connector 3190-2935

Mechanical Specifications		
Performance Property	Units	US/Metric
Diameter	in.(mm)	1.2 / (30.5)
Weight	lb/ft(kg/m)	0.491/ (0.73)
Crush Strength	lb/in.(kg/mm)	250 / (4.4)
Max.2 Ohm imp. change		
Tensile Strength	lb (kg)	800 / (360)
Minimum bend radius	in.(mm)	6.5 / (165)

### % Probability of Communication

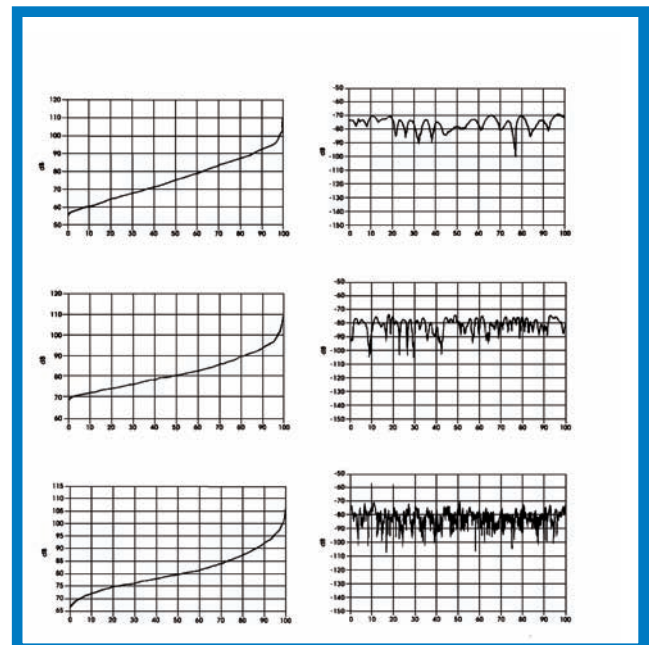

# nu-TRAC®

## TRC-1250

- Provides interior communications in tunnels, subways, ships and metal framed buildings
- Offers stable electrical performance
- More flexible than corrugated designs
- No need for cable standoffs

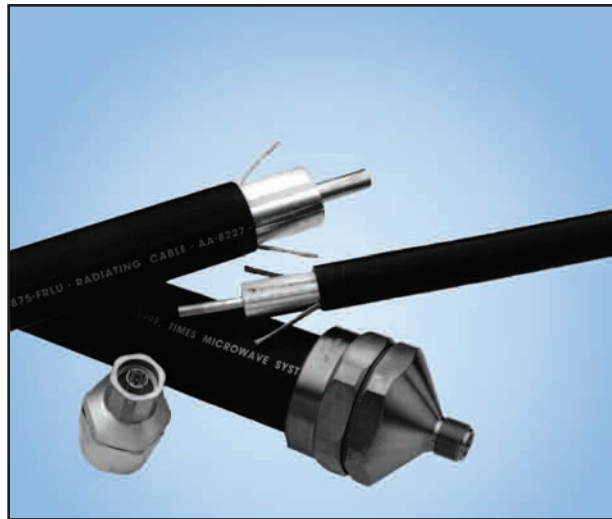

Electrical Specifications			
Performance Property	Units	US	Metric
Velocity of Propagation	%	86	
Impedance	Ohms	50	
VSWR, typical 150-900 MHz		1.2	
Coupling Loss	dB @ 20 ft		
150 MHz		74	
450 MHz		79	
900 MHz		80	
1900 MHz		78	
2400MHz		79	
Attenuation	dB / 100 ft / 100 meters		
150MHz		0.39	1.3
450MHz		0.79	2.6
900MHz		1.23	4.0
1900 MHz		1.95	6.40
2400MHz	2.40	7.90	

Part Description	
Type No.	
<b>Cables</b>	
TRC 1250-PE	- Polyethylene - outdoor version
TRC 1250-VW1	- Non-halogen, fire retardant polyolefin
TRC 1250-FR	- Highly fire retardant non-halogen polyolefin
<b>Connectors</b>	
TRB 1250-NF	- "N" female connector (P/N 3190-2309)
TRB 1250-NM	- "N" male connector (P/N 3190-2310)

Mechanical Specifications		
Performance Property	Units	US/Metric
Diameter	in.(mm)	1.67 / (42.4)
Weight	lb/ft(kg/m)	.742 / (1.10)
Crush Strength	lb/in.(kg/mm)	300 / (5.3)
Max.2 Ohm imp. change		
Tensile Strength	lb (kg)	1500 / (680)
Minimum bend radius	lb/in.(kg/mm)	13.5 / (342)

### % Probability of Communication

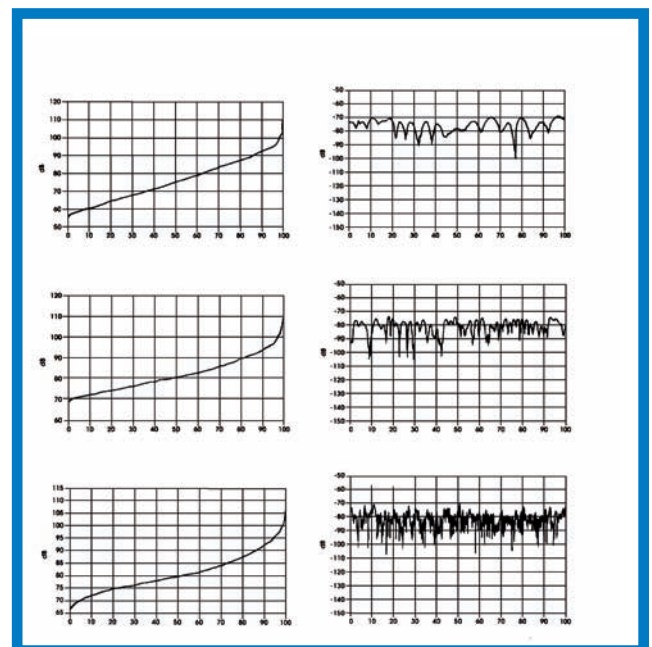

CONNECTOR ATTACHMENT PROCEDURE FOR nu-TRAC-1250  
CONNECTORS: PART NUMBERS 3190-2309 AND 3190-2310



**Step 1:** Connector assembly parts for nuTRAC-1250FR (With modified collar and adhesive copper tape).



**Step 2:** Slide backnut and gasket onto cable. Trim and remove 13/32" of the cable jacket. NOTE: Do not cut the outer drain wire.

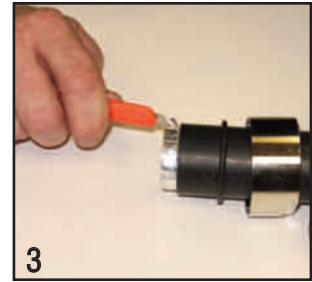

**Step 3:** Locate the inner drain wire (opposite the outer drain and under clear inner jacket). Slit the inner clear poly along the inner drain wire and pull back towards the jacket. Both drain wires will be exposed.

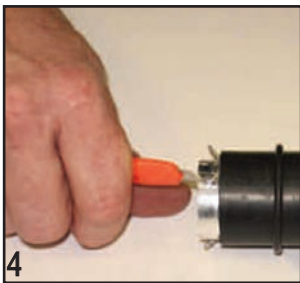

**Step 4:** Remove clear poly inter-layer by slitting each end of the tape longitudinally away from the jacket to the end of the cable. Use the inner jacket as a guide to remove each piece of the poly. Do not cut into inner tape. The inner shield will now be fully exposed.

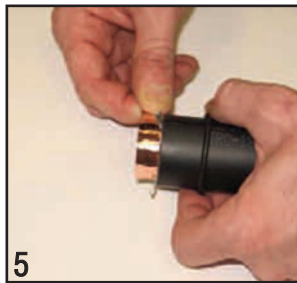

**Step 6:** Apply adhesive copper tape completely around the cable core shields. Both inner and outer shield will be in full contact with tape. Both drain wires will be outside the copper tape.

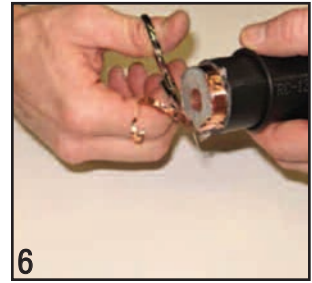

**Step 7:** Trim the copper tape so that it is even with the core.



**Step 8:** Slide on the gland washer over both drain wires. The gland washer will seat against the outer jacket. Push back each drain and push on the slotted collar over the tape. NOTE: The gland washer and collar are angled for proper fit. Both drain wires will be clamped between the gland washer and collar.



**Step 9:** Push in the connector inner conductor into the hollow copper tube inner cable conductor. Push on the connector head and attach to the backnut.



**Step 10:** Using 2.0" box wrenches, fully tighten down the connector until snug. Go one-quarter turn to completely tighten. NOTE: It is recommended to use an additional stress boot at the cable to connector interface. A shrink boot, silicone tape or strong electrical tape will add strength.

# T-RAD connector installation procedure



**Step 1:** Flush cut the cable squarely

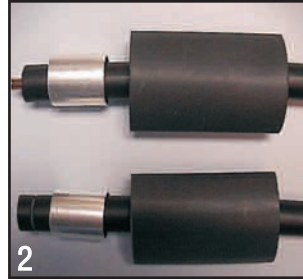

**Step 2:** Slide the heat shrink and TR-600 crimp ring over the cable. Use a knife or razor blade to cut a 0.250" long ring from the end of the cable. Make sure that the cut is square

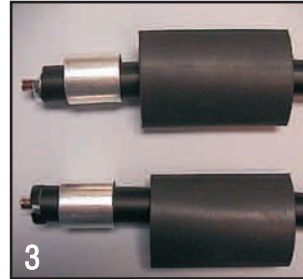

**Step 3:** Lightly score the circumference of the cable 0.20" back from the end of the core. Make one long longitudinal cut. Pry up a piece of the jacket and gently peel the ring of the jacket off the core.

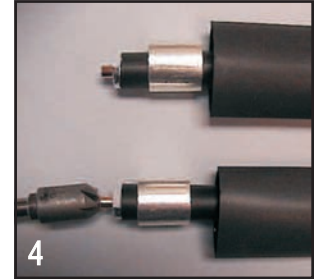

**Step 4:** Deburr the center conductor using the DBT-01 deburring tool



**Step 5:** Slide the connector over the end of the core and push it up to the end of the jacket. Rotate the connection back and forth in a clockwise-counter clockwise motion in reference to the axis of the cable until the back of the connector works its way under the end of the jacket. Now push the connector onto the cable with some back and forth motion until it stops.

*Note: A small longitudinal cut of 1/4" may be made to the outer jacket to assist with the connector body sliding under the jacket*

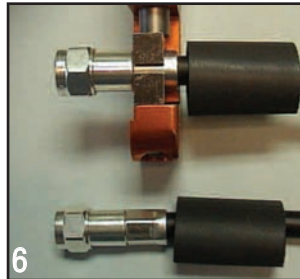

**Step 6:** Position the heavy duty HX-4 crimp tool with the appropriate dies (stock code 3190-203) directly behind and adjacent to the connector body, and crimp the connector. The crimp tool automatically releases when the crimp is complete.



**Step 7:** Position the heat shrink boot as far forward on the connector body as possible without interfering with the coupling nut; use a heat gun to form a weather tight seal.

# Other Catalogs Available From Times Microwave Systems

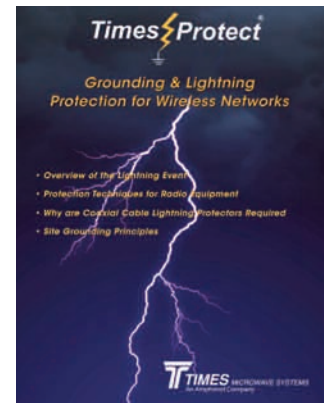

## Our Mission

TIMES MICROWAVE SYSTEMS designs and manufactures high performance RF transmission lines. These products consist of flexible coaxial cable, connectors, accessories and cable assemblies.

We are committed to understanding the needs and requirements of our customers and providing highly engineered, cost effective products. TIMES MICROWAVE SYSTEMS is dedicated to total customer satisfaction and superior results for our shareholders in all we do.



World Headquarters: 358 Hall Avenue Wallingford, CT 06492 • Tel: (203) 949-8400 • (800) 867-2629 • Fax: (203) 949-8423  
International Sales: 4 School Brae, Dysart, Kirkcaldy, Fife, Scotland KY1 2XB UK Tel: +44(0)1592655428  
China Sales: TMC Building 4, No. 318 Yuanshan Road, Xinzhuang Industrial Park, Shanghai, China 201108 Tel: 86-21-5176-1209 Fax: 86-21-64424098  
[www.timesmicrowave.com](http://www.timesmicrowave.com)