

Part Number
10104109-0001LF

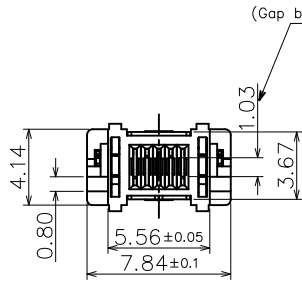

(Gap between Pin, PCB Thickness)

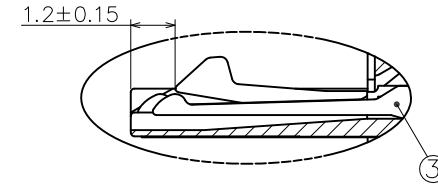
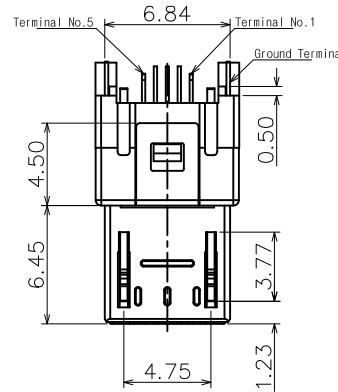
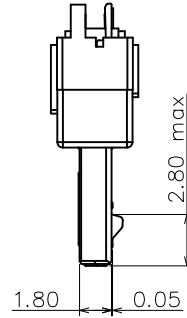
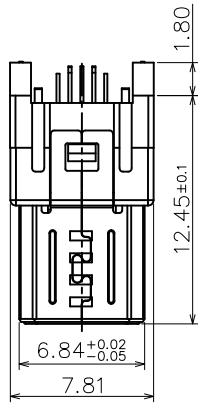
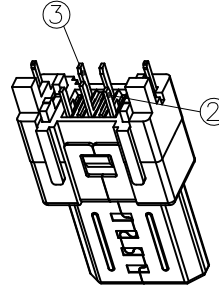
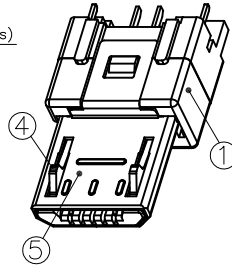

Plug Contact -A Point -2EA (No.2, No.4)
Plug Contact -B Point -1EA (No.3)

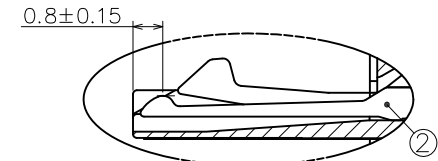

Plug Contact -B Point -2EA (No.1, No.5)

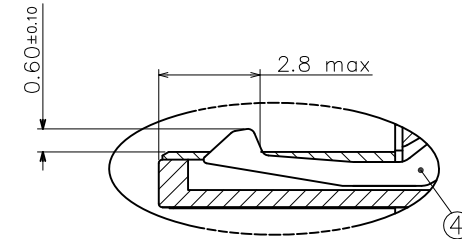

Plug Contact -LOCK TML' Point -2EA

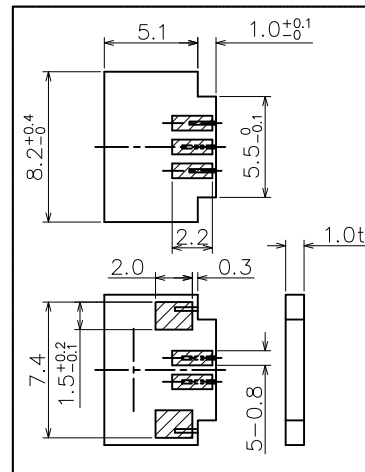
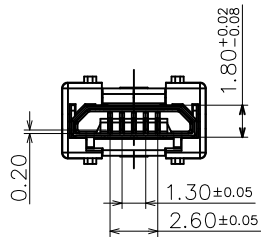

*PCB ref.
(Tolerance ±0.05)

(Table-1)

No.	Part Name	Material	Finish	Remarks
1	Plug Housing	Thermoplastic	black	
2	Plug Contact -B	Copper alloy	Selective Gold Plated	
3	Plug Contact -A	Copper alloy	Selective Gold Plated	
4	Lock Plate	Sustainess steel		
5	Plug Shield	Sustainess steel	Ni Plated	

-Note-

1. Material & finish: See table-1
2. Packing in tray

mat'l. code				tolerances unless otherwise specified		CUSTOMER COPY		FCI		www.fciconnect.com		
ltr	ecn no	dr	date	linear	.X ± 0.38	projection	title	MICRO-USB B-TYPE PLUG				
A	T10-0002	J.H	01/07/10		.XX ± 0.25							
					.XXX ± 0.10							
				angles	0° ±2°	MM	product family	USB	code	TWN	sheet	
				dr	JASON HSU							01/07/10
				enr	JASON HSU							01/07/10
				chr	GARY HSIEH	01/07/10	size	dwg no				
				appd	JOSEPH HSIA	01/07/10	scale	1:1	A4	10104109	1 of 1	
sheet index	revision sheet	A	1									