



**austriamicrosystems AG**

**is now**

**ams AG**

The technical content of this austriamicrosystems datasheet is still valid.

**Contact information:**

**Headquarters:**

ams AG

Tobelbaderstrasse 30

8141 Unterpremstaetten, Austria

Tel: +43 (0) 3136 500 0

e-Mail: [ams\\_sales@ams.com](mailto:ams_sales@ams.com)

Please visit our website at [www.ams.com](http://www.ams.com)

# AS3635

## Xenon Flash Driver with 5V IGBT Control



### 1 General Description

The AS3635 is a highly integrated photoflash charger with built in IGBT driver.

A built in 5V charge-pump guarantees constant IGBT drive at any battery voltage. The built in timer turns off the charge-pump 20 seconds after charging.

In circuit fuse trimming allows to set the voltage on the photoflash capacitor to  $\pm 3\%$  accuracy.

The AS3635 is available in a space-saving WL-CSP package measuring only 1.5mm x 1.5mm and operates over the  $-30^{\circ}\text{C}$  to  $+85^{\circ}\text{C}$  temperature range.

### 2 Key Features

- Built in 5V charge-pump for IGBT gate drive
- Photoflash voltage accuracy programmable to  $\pm 3\%$  (in circuit One Time Programmable - OTP)
- Trip voltage accuracy  $\pm 1.5\%$
- Small Size 1.5mm x 1.5mm x 0.6mm
- PCB: No microvias need
- Average input current  $< 320\text{mA}$
- Few external components
  - No Schottky-Diode needed
  - No output voltage divider needed
- Reliable Flash on/off for IGBT timing.
- Charge time  $< 4\text{sec}$  @  $V_{\text{bat}} > 2.7\text{V}$ ,  $C_{\text{FLASH}} = 22\mu\text{F}$
- Charge complete indicator
- Undervoltage lockout
- Available in a tiny WL-CSP Package  
3x3 balls 0.5mm pitch, 1.5x1.5mm package size

**Warning:** Lethal voltages are present on applications using AS3635! Do not operate without training to handle high voltages.



### 3 Applications

Xenon Flash driver for mobile phones, PDA and DSC

Figure 1. Typical Operating Circuit

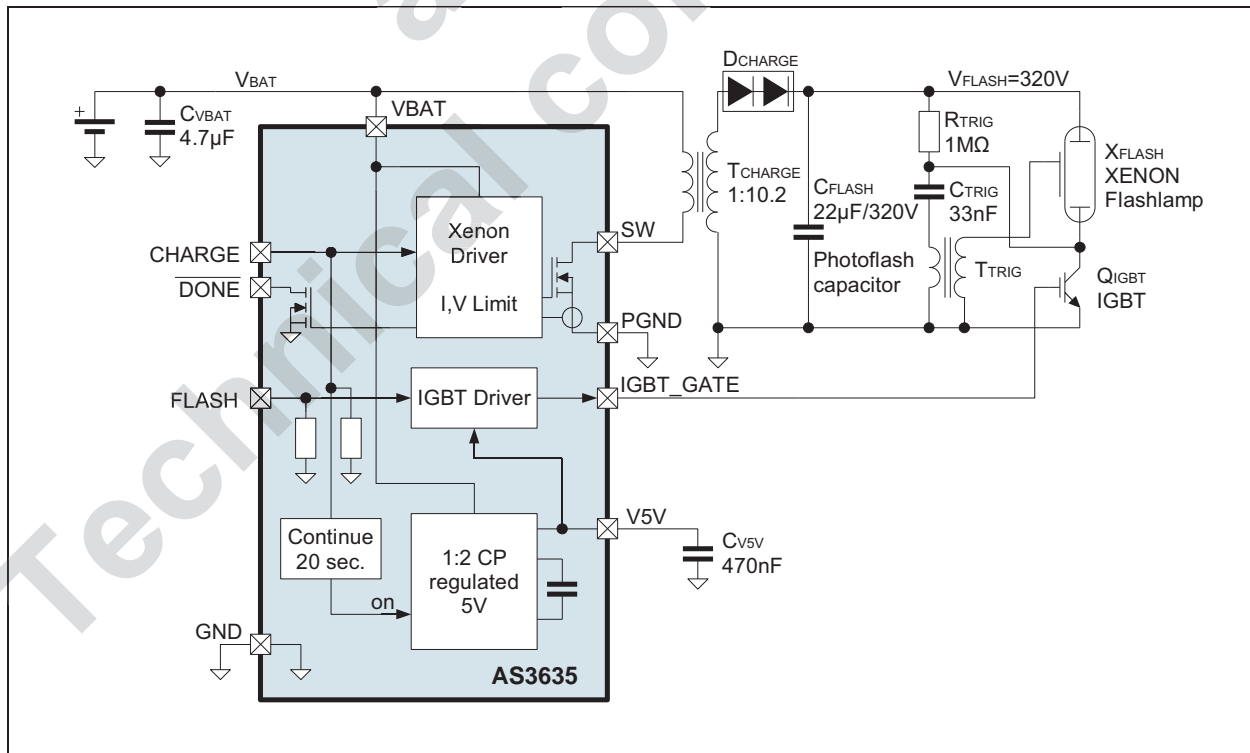

## 4 Pinout

### Pin Assignment

Figure 2. Pin Assignments (Top Through View)

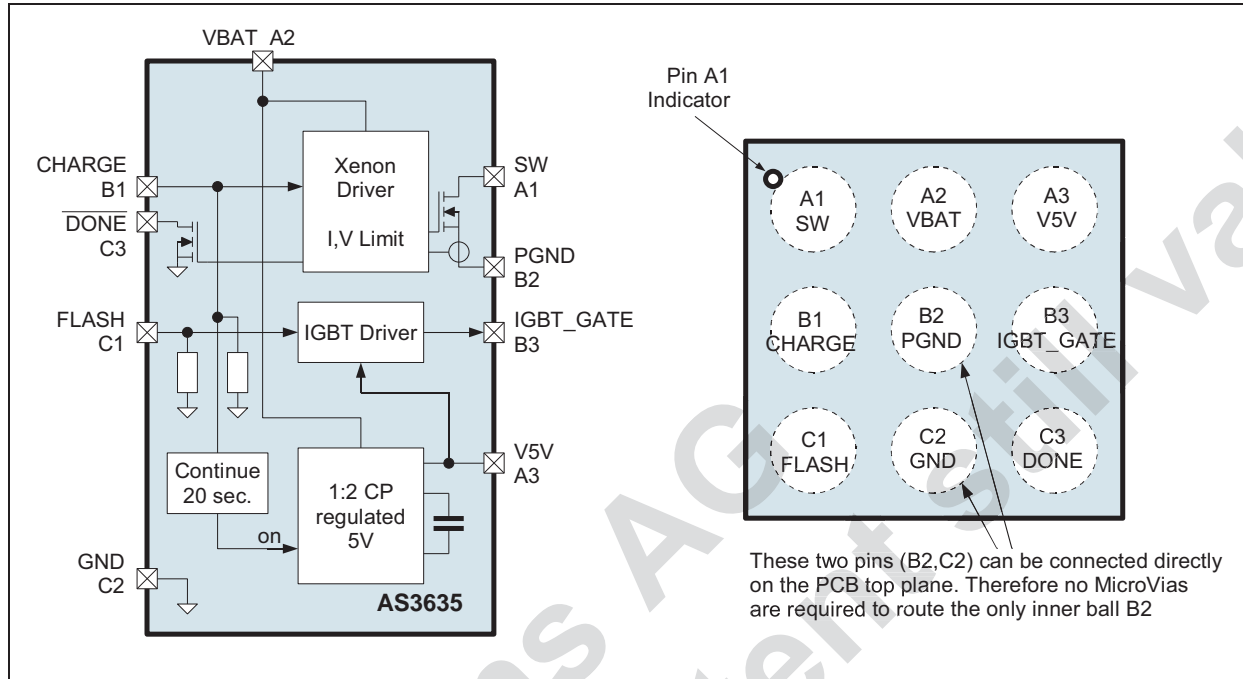

### Pin Description

Table 1. Pin Description for AS3635

Pin Number	Pin Name	Description
A1	SW	Xenon DCDC converter switching node
A2	VBAT	Positive supply voltage input
A3	V5V	5V charge pump output
B1	CHARGE	Digital input pin, active high - enables charging of photoflash capacitor
B2	PGND	Power ground - connect to ground (GND)
B3	IGBT_GATE	IGBT gate control - internally level shifted to 5V (from pin V5V)
C1	FLASH	Digital input pin, active high - Enables flash (level shifted to IGBT_GATE)
C2	GND	Signal ground - connect to ground (GND)
C3	DONE	Digital open drain output, active low - indicates end of charging

## 5 Absolute Maximum Ratings

Stresses beyond those listed in Table 2 may cause permanent damage to the device. These are stress ratings only, and functional operation of the device at these or any other conditions beyond those indicated in Table 3, "Electrical Characteristics," on page 4 is not implied. Exposure to absolute maximum rating conditions for extended periods may affect device reliability.

Table 2. Absolute Maximum Ratings

Parameter	Min	Max	Units	Comments
VBAT, V5V to GND	-0.3	+7.0	V	
CHARGE, $\overline{\text{DONE}}$ , FLASH to GND	-0.3	VBAT + 0.3	V	maximum 7.0V
IGBT_GATE to GND	-0.3	V5V + 0.3	V	
SW to PGND	-0.3	+55.0	V	
PGND to GND	0.0	0.0	V	Connect PGND to GND directly below the pad (short connection recommended)
Input Pin Current without causing latchup	-100	+100 +I <sub>IN</sub>	mA	Norm: EIA/JESD78
<b>Continuous Power Dissipation (T<sub>A</sub> = +70°C)</b>				
Continuous power dissipation		0.76	W	P <sub>T</sub> <sup>1</sup>
<b>Electrostatic Discharge</b>				
ESD pins VBAT, CHARGE, $\overline{\text{DONE}}$ , FLASH <sup>2</sup>		±15000	V	Air Discharge to module; IEC 61000 -4 -2 test bench
		±8000	V	Contact Test to module; IEC 61000 -4 -2 test bench
ESD HBM pins SW, IGBT_GATE, PGND, V5V		±2000	V	Norm: MIL 883 E Method 3015
ESD CDM		±500	V	Norm: JEDEC JESD 22-C101C
ESD MM		±100	V	Norm: JEDEC JESD 22-A115-A level A
<b>Temperature Ranges and Storage Conditions</b>				
Storage Temperature Range	-55	+125	°C	
Humidity	5	85	%	Non condensing
Body Temperature during Soldering		+260	°C	according to IPC/JEDEC J-STD-020
Moisture Sensitivity Level (MSL)		MSL 1		Represents a max. floor life time of unlimited

1. Depending on actual PCB layout and PCB used
2. Assembled on PCB board (requires capacitor C<sub>VBAT</sub>); special PCB layout (spark gaps) and external resistors required; system test for completed module (fully capsuled), no permanent interruption of operation

## 6 Electrical Characteristics

V<sub>BAT</sub> = +2.51V to +5.5V, T<sub>AMB</sub> = -30°C to +85°C, unless otherwise specified. Typical values are at V<sub>BAT</sub> = +3.6V, T<sub>AMB</sub> = +25°C, unless otherwise specified.

Table 3. Electrical Characteristics

Symbol	Parameter	Condition	Min	Typ	Max	Unit	
<b>General Operating Conditions</b>							
V <sub>BAT</sub>	Supply Voltage		2.51 <sup>1</sup>	3.6	5.5	V	
T <sub>AMB</sub>	Operating Temperature		-30	25	85	°C	
I <sub>SHUTDOWN</sub>	Shutdown Current	CHARGE = 0, charge pump OFF, FLASH = 0 T <sub>AMB</sub> < 50°C; V <sub>BAT</sub> < 3.7V		0.5	1.0	µA	
V <sub>UVLO</sub>	Undervoltage Lockout	Measured on pin V <sub>BAT</sub>	2.3		2.5	V	
<b>V<sub>FLASH</sub> Capacitor Charger</b>							
V <sub>TRIP</sub>	Comparator trip voltage	V(SW) - V(V <sub>BAT</sub> ) in circuit adjustable with OTP. T <sub>AMB</sub> = 0°C to 50°C; only if V <sub>TRIP</sub> is trimmed by austriamicrosystems	31.9	32.4	32.9	V	
V <sub>TRIPRANGE</sub>	Programming range of V <sub>TRIP</sub>	5 bit programming 32.4V -11.2%/+10.5%; measured on pin SW Allows in-circuit trimming of the final charged voltage V <sub>FLASH</sub> on capacitor C <sub>FLASH</sub>	29.6		35.8	V	
V <sub>SW</sub>	Maximum voltage on pin SW				50	V	
I <sub>SW</sub>	Switching current limit		0.75	0.9	1.05	A	
R <sub>SW</sub>	Switch on resistance	Internal transistor between SW and PGND		0.4		Ω	
t <sub>EOC_DET</sub>		end of charge comparator trigger time - see Internal Circuit on page 8	128	138	148	ns	
<b>Charge Pump Parameters</b>							
V <sub>V5V</sub>	5V Charge pump output voltage	5.25 > V <sub>BAT</sub> > 2.7V	4.75	5.0	5.25	V	
		2.7V > V <sub>BAT</sub> > 2.51V	4.3		5.25		
I <sub>CHRG_PUMP</sub>	Charge Pump Operating Current	CHARGE= 0->1->0 (20 seconds timer running <sup>2</sup> ), charge pump ON includes 48µA for internal biasing and oscillator		163		µA	
f <sub>CLK</sub>	Operating frequency			2.0		MHz	
<b>IGBT Control - See IGBT Driver on page 13</b>							
I <sub>BGTRISE</sub>	IGBT control voltage rise time	Pin IGBT_GATE, rise/falltime 10% - 90%, V <sub>5V</sub> =5V, T <sub>AMB</sub> =25°C, V <sub>IN</sub> =3.7V, AS3635E, load: 6.5nF (capacitor)	0.171	0.214	0.256	µs	
I <sub>BGTFALL</sub>	IGBT control voltage fall time		0.42	0.525	0.63	µs	
R <sub>IGBT_ON</sub>	IGBT switching on resistance	T <sub>AMB</sub> =-30°C to 85°C	AS3635B	30	50	60	Ω
			AS3635E	5	15	20	Ω
I <sub>IGBT_SINK</sub>	IGBT Sink Current	V <sub>IGBT_GATE</sub> below 2.3V; T <sub>AMB</sub> =-30°C to 85°C	AS3635B	10	15	20	mA
			AS3635E	52	60	70	mA
I <sub>IGBT_BOOST</sub>	IGBT Boost Current	V <sub>IGBT_GATE</sub> above 2.3V; T <sub>AMB</sub> =-30°C to 85°C	40	46	53	mA	
<b>Digital Interface</b>							

Table 3. Electrical Characteristics (Continued)

Symbol	Parameter	Condition	Min	Typ	Max	Unit
V <sub>IH</sub>	High Level Input Voltage	Pins CHARGE, FLASH;	1.26			V
V <sub>IL</sub>	Low Level Input Voltage	pin $\overline{\text{DONE}}$ in trimmode	0.0		0.54	V
V <sub>OL</sub>	Low Level Output Voltage	Pin $\overline{\text{DONE}}$ , I <sub>LOAD</sub> =4mA			0.2	V
I <sub>LEAK</sub>	Leakage current	Pin $\overline{\text{DONE}}$	-1		+1	μA
R <sub>PD</sub>	Pulldown resistance to GND <sup>3</sup>	Pins CHARGE, FLASH		52		kΩ
<b>Recommended Transformer parameters - see Table 4, "Recommended Transformers," on page 15</b>						
L <sub>PRIMARY</sub>	Primary Inductance		6			μH
L <sub>LEAK</sub>	Primary Leakage Inductance				0.4	μH
N	Turns Ratio	for V <sub>FLASH</sub> =320V (final charged voltage on CFLASH)		10.2		
V <sub>ISOLATION</sub>	Isolation Voltage		500			V
I <sub>SATURATION</sub>	Primary Saturation Current		0.84			A
R <sub>PRIMARY</sub>	Primary Winding Resistance				0.4	Ω
R <sub>SECONDARY</sub>	Secondary Winding Resistance				60	Ω

1. Minimum V<sub>BAT</sub> is set to 2.51V to allow a little margin to maximum V<sub>UVLO</sub> undervoltage lockout of 2.5V.
2. Setting CHARGE=1 resets the timeout timer. Additionally the timeout timer is automatically stopped at power on reset and once it has expired.
3. Measured with V<sub>BAT</sub>=3.7V, CHARGE or FLASH = 1.26V

## 7 Typical Operating Characteristics

VBAT = 3.6V, T<sub>A</sub> = +25°C (unless otherwise specified). CFLASH=22μF, T<sub>CHARGE</sub> Transformer = TTRN-3822, QIGBT=RJP4002ANS, I<sub>SW</sub>=750mA.

Figure 3. Charging Waveform

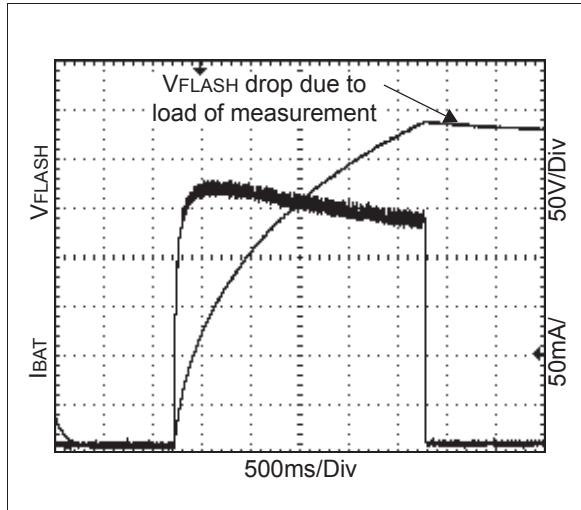

Figure 4. Charging Time vs. VBAT

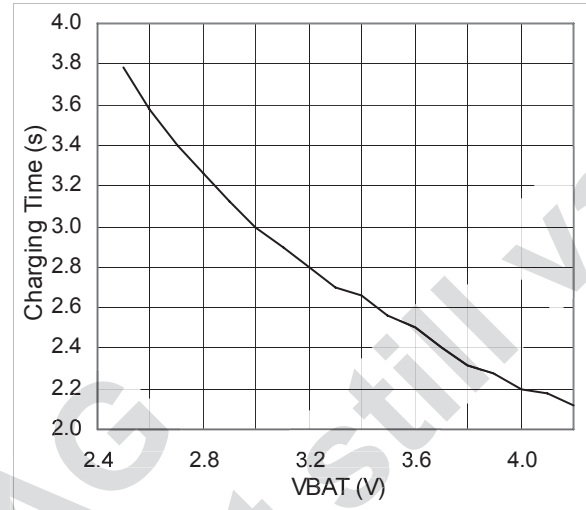

Figure 5. Charging Waveform VBAT=2.51V

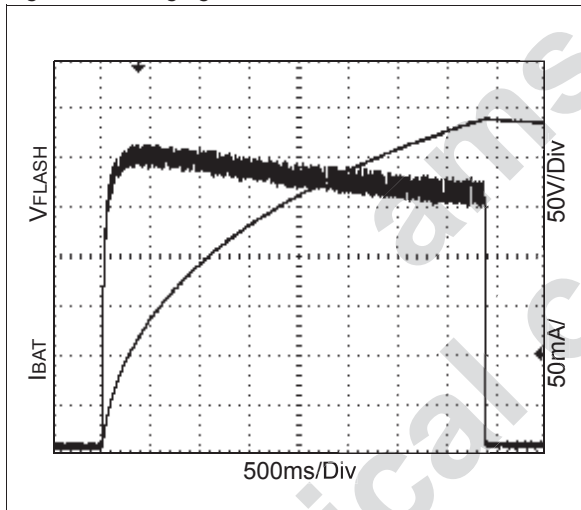

Figure 6. Charging Waveform VBAT=4.2V

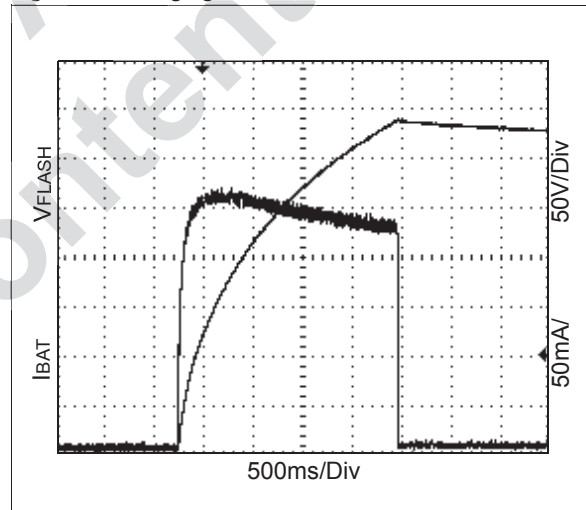

Figure 7. Efficiency vs. VFLASH

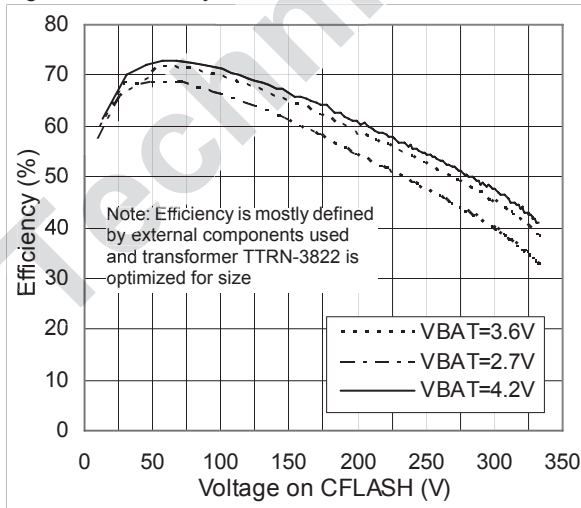

Figure 8. Efficiency vs. Charging Time

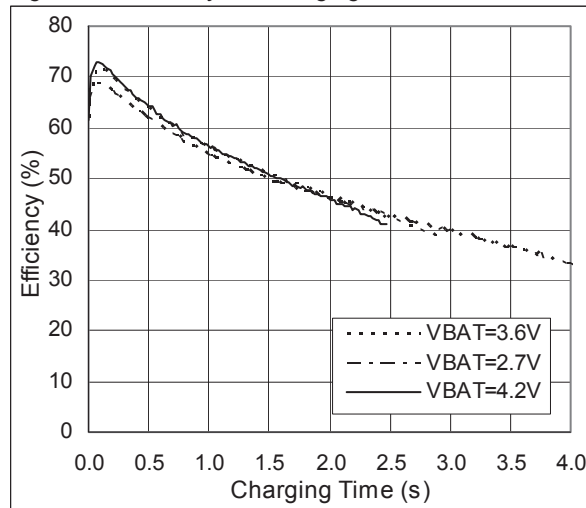

Figure 9. End of charge Voltage vs. VBAT

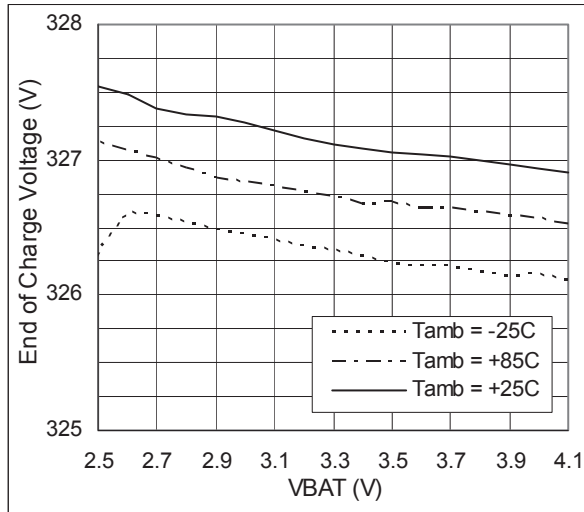

Figure 10. IGBT\_GATE driving waveform

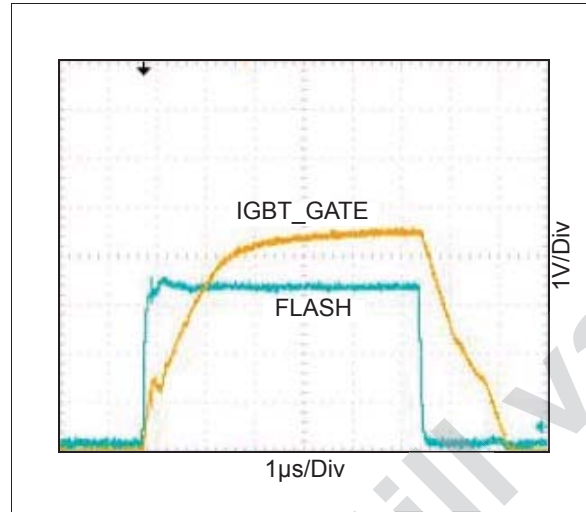

Figure 11. SW switching waveform

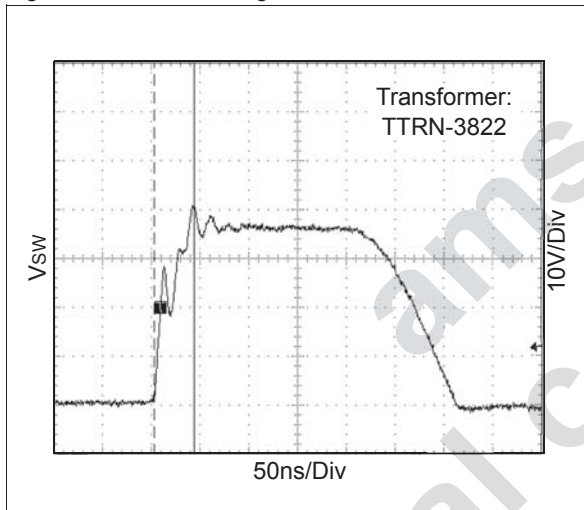

Figure 12. SW switching waveform

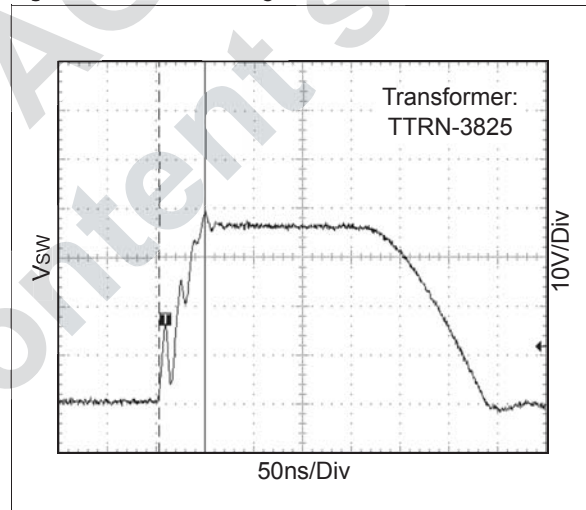

Figure 13. V5V vs. VBAT (V5V CP on)

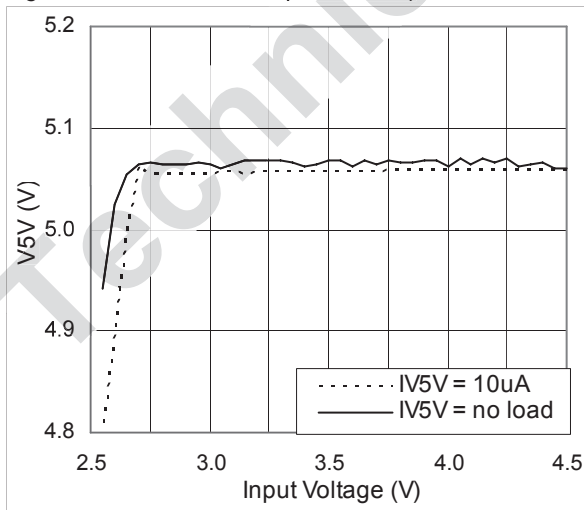
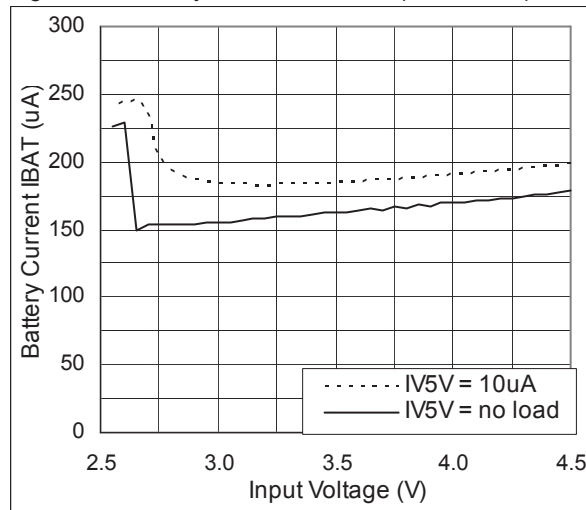

Figure 14. Battery current vs. VBAT (V5V CP on)





## 8 Detailed Description

The AS3635 is a photoflash capacitor charger and an integrated IGBT driver for a Xenon flash. The capacitor charger charges  $V_{FLASH}$  to the final charging voltage (e.g. 320V) and the IGBT driver starts the actual Xenon flash.

Additionally a charge pump is included to generate a stable 5V supply for accurate control of the IGBT on/off timings independent of the battery supply.

The final charged voltage ( $V_{FLASH}$ ) can be in-field trimmed to e.g. 320V with the integrated OTP (one time programmable) memory (see section [Trimming Procedure on page 12](#)).  $V_{FLASH}$  can be exactly trimmed to the maximum allowed output voltage resulting in an improved use of the available energy in the photoflash capacitor.

**Note:** The AS3635 uses a WL-CSP (wafer level chip scale package) to optimize the PCB area required and minimize the module size. Therefore the actual DIE is visible (and it is not molded in plastic as for other packages like QFN or DFN) and the AS3635 is sensitive to external light. It has to be protected from direct light from the Xenon tube.

### Internal Circuit

Figure 15. Internal circuit

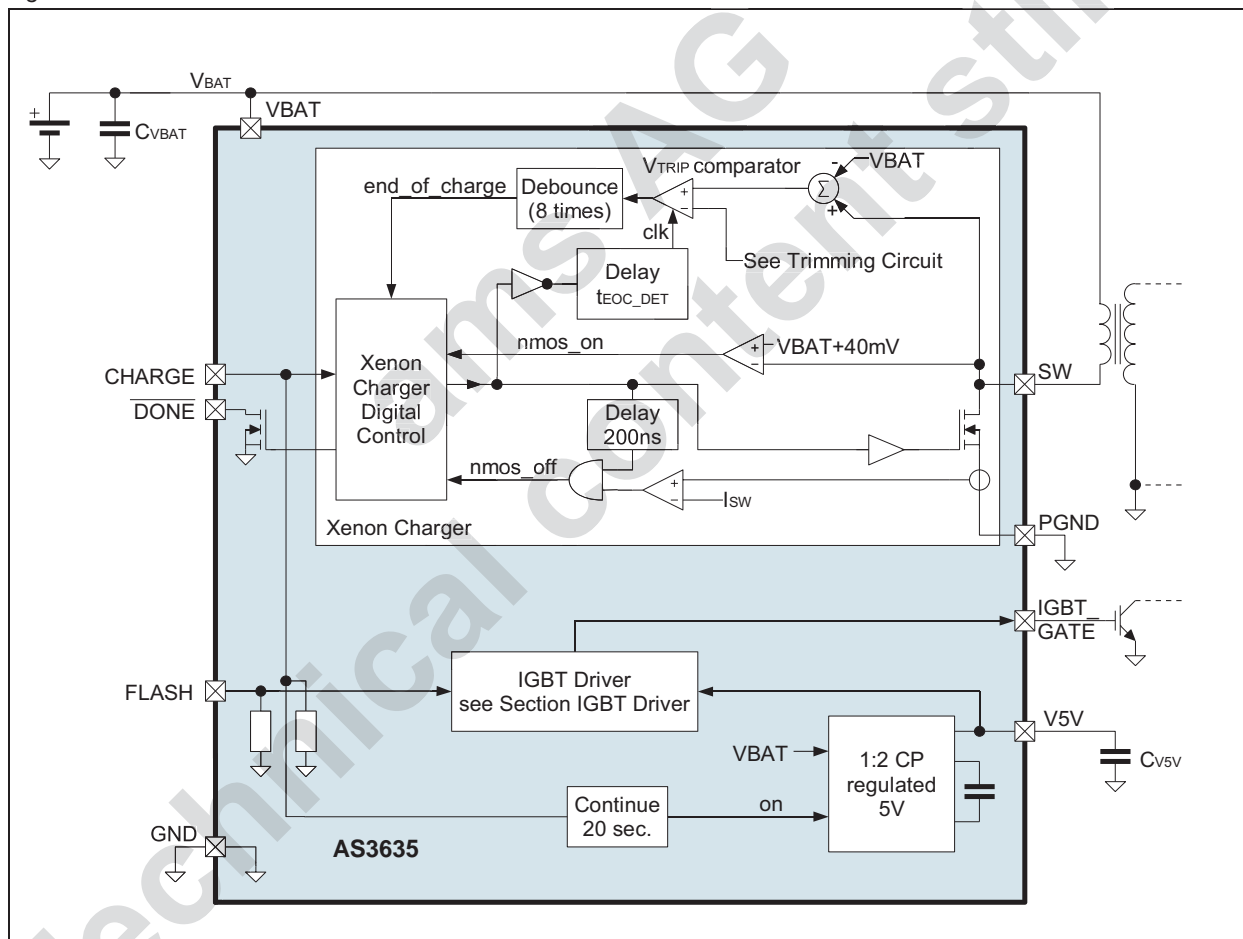

### AS3635 Operation

The AS3635 allows charging and refresh cycles under complete software control. Two typical configurations are shown in [Figure 16](#) and [Figure 17](#):

[Figure 16](#) shows a configuration without any refresh between the pre-flash and the actual flash. Typically this is used for applications where no noise at all should be generated on the battery when the camera is performing e.g. white color balancing (between pre-flash and flash cycle).

Figure 16. AS3635 Charging Cycle without recharging between Pre-Flash and Flash

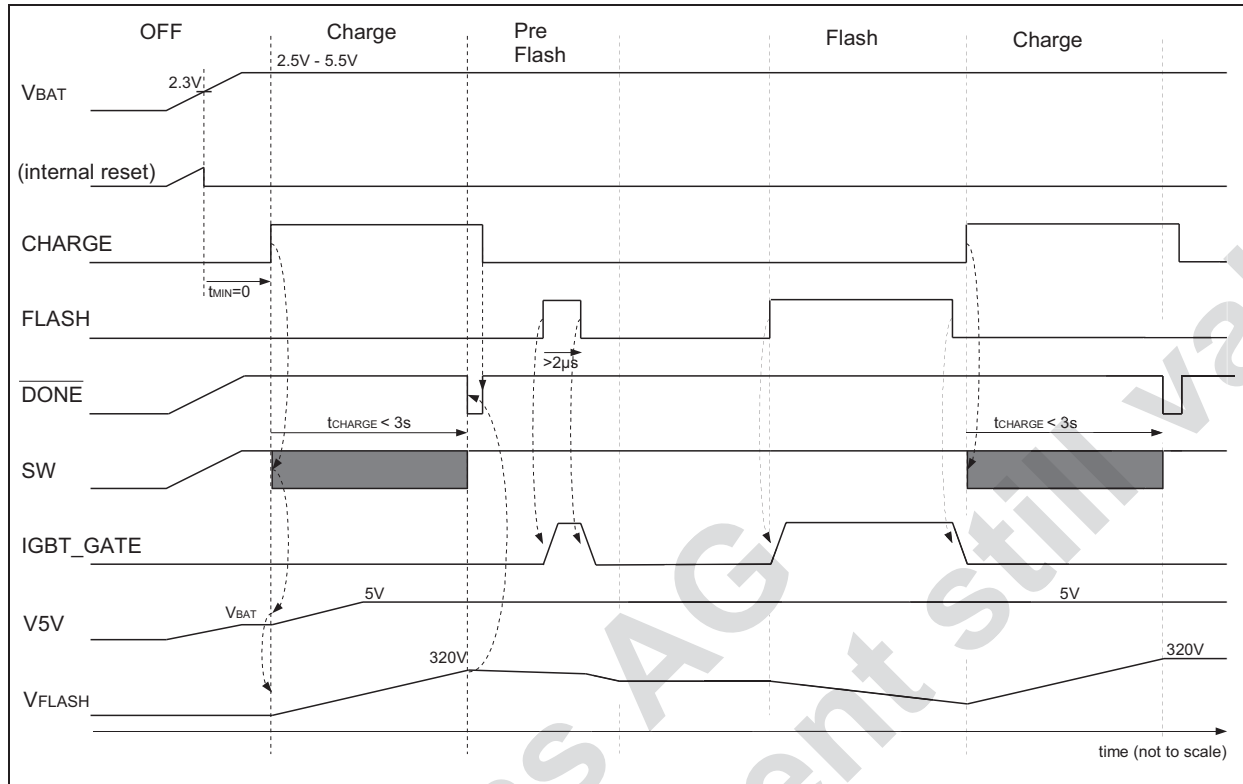
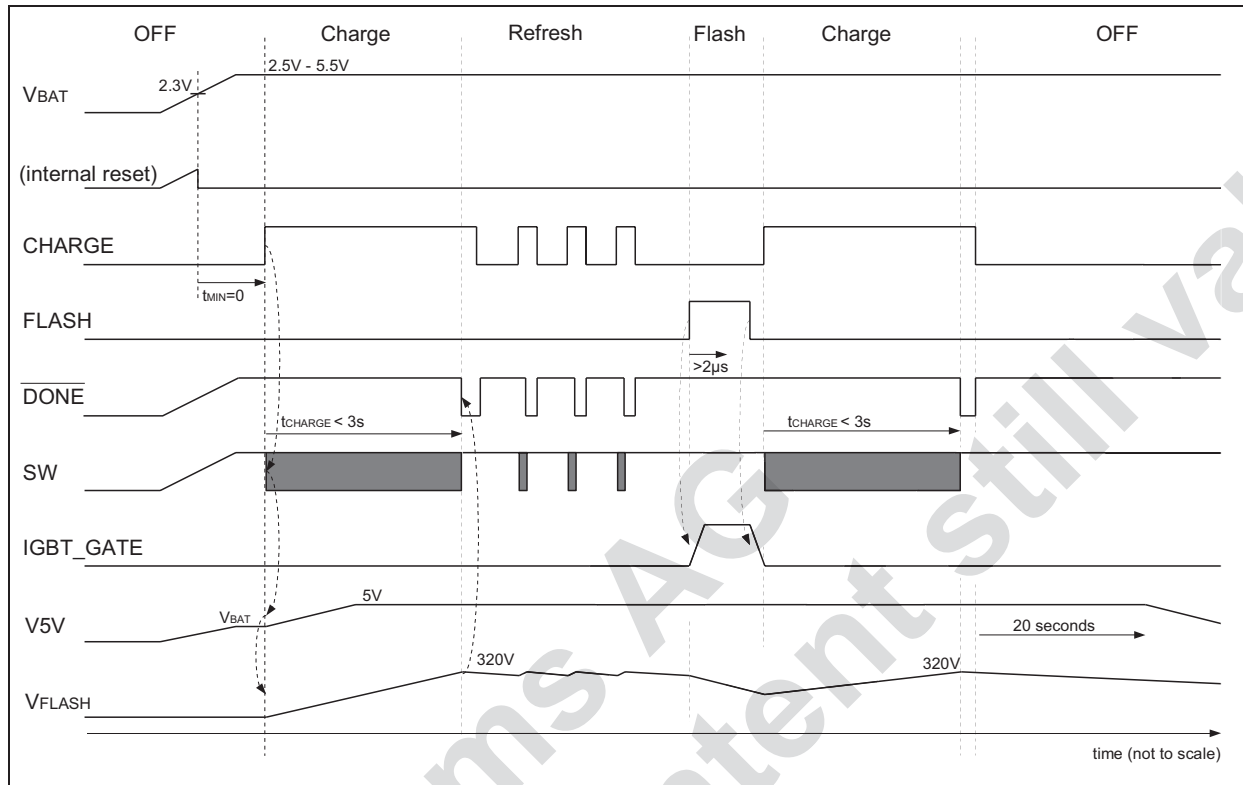

Figure 17 shows a configuration with continuous refresh of the voltage on the photoflash capacitor (VFLASH). Typically this is used in application where the maximum flash energy should be used.

Figure 17. AS3635 Charging Cycle with continuous recharging



A typical charging cycle and its voltages and current on the different pins and signals are shown in Figure 18:

Figure 18. AS3635 Charging Cycle Details

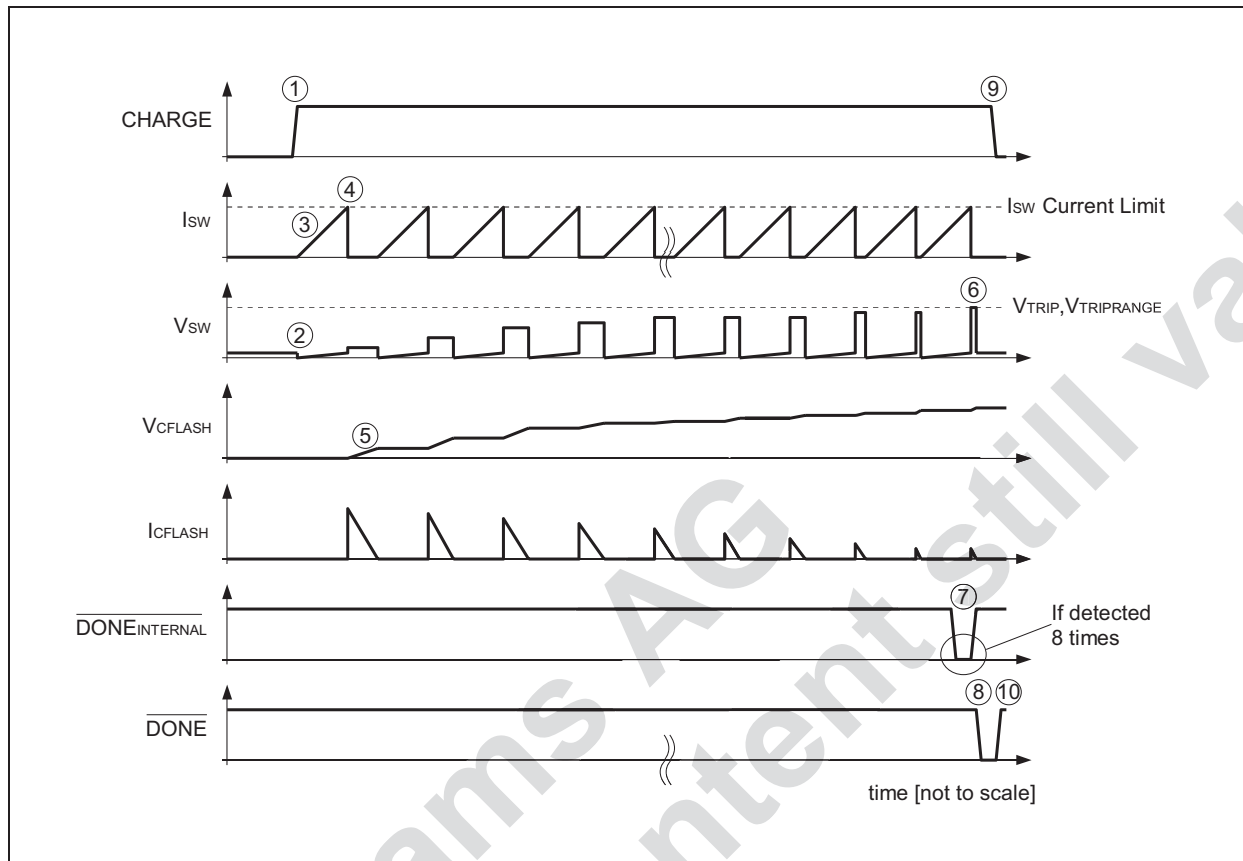

The input CHARGE is set to high and charging begins (1).

During a single cycle, the internal NMOS transistor connects the pin SW to PGND (2). Therefore the current  $I_{sw}$  rises (3) until it reaches  $I_{sw}$  current limit (4). Then the energy is transferred to the secondary side of the transformer and the voltage  $V_{cFLASH}$  on the flash capacitor  $C_{FLASH}$  rises (5).

The output voltage  $V_{cFLASH}$  gradually increases and once it hits the end of charge detection threshold (6) (detected on  $V_{sw}$  during the off time of the NMOS transistor between SW and PGND) 8 times (7)<sup>1</sup>,  $\overline{DONE}$  is pulled low (8). When CHARGE is set to low afterwards (9),  $\overline{DONE}$  returns to high (10) finishing a full charging cycle.

**Note:** For simplicity the number of actual charging cycles (NMOS SW on/off) are reduced in Figure 18.

1. The 8 cycles required for actual detection of the end of charge conditions are not shown in Figure 18.

## Trimming Procedure

The final charging voltage on  $V_{FLASH}$  can be trimmed in-circuit to cancel inaccuracies of  $V_{FLASH}$  due to the transformer and diode. The trimming procedure is performed as follows:

Figure 19. AS3635 trimming circuit<sup>2</sup>

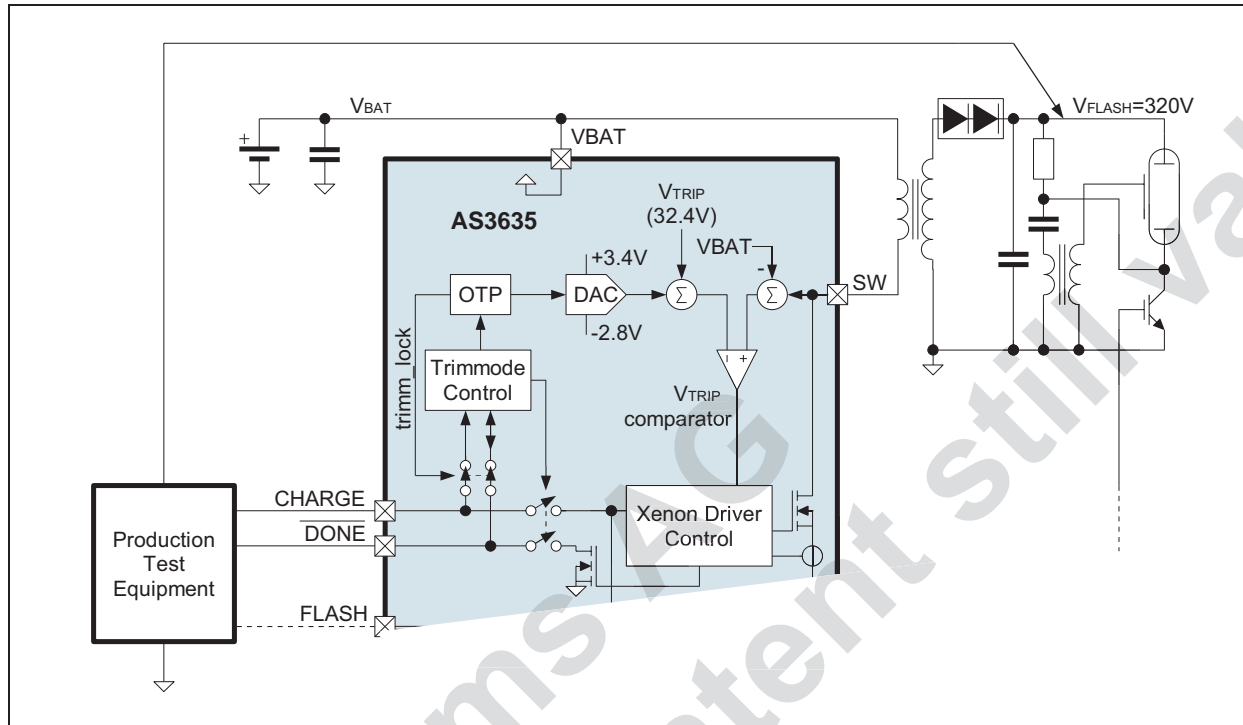

1. The production test equipment starts a charging cycle ( $CHARGE=1$ ) and waits until  $\overline{DONE}=0$
2. The voltage on  $V_{FLASH}$  is measured and a correction code is calculated
3. The trimmode control is unlocked using a special sequence
4. The one time programmable memory (OTP) is programmed with the above calculated code
5. The trimmode control can be disabled by fusing the OTP bit  $trimm\_lock$

See austriamicrosystems application note 'AN3635\_In-Production\_Trimming' for a detailed description of the trimming setup and the trimming procedure.

<sup>2</sup> 2. The internal voltages (e.g. +3.4V/-2.8V/32.4V) are internally scaled to fit in the supply voltage range

## IGBT Driver

The internal circuit of the IGBT driver is shown in Figure 20:

Figure 20. IGBT Driver circuit

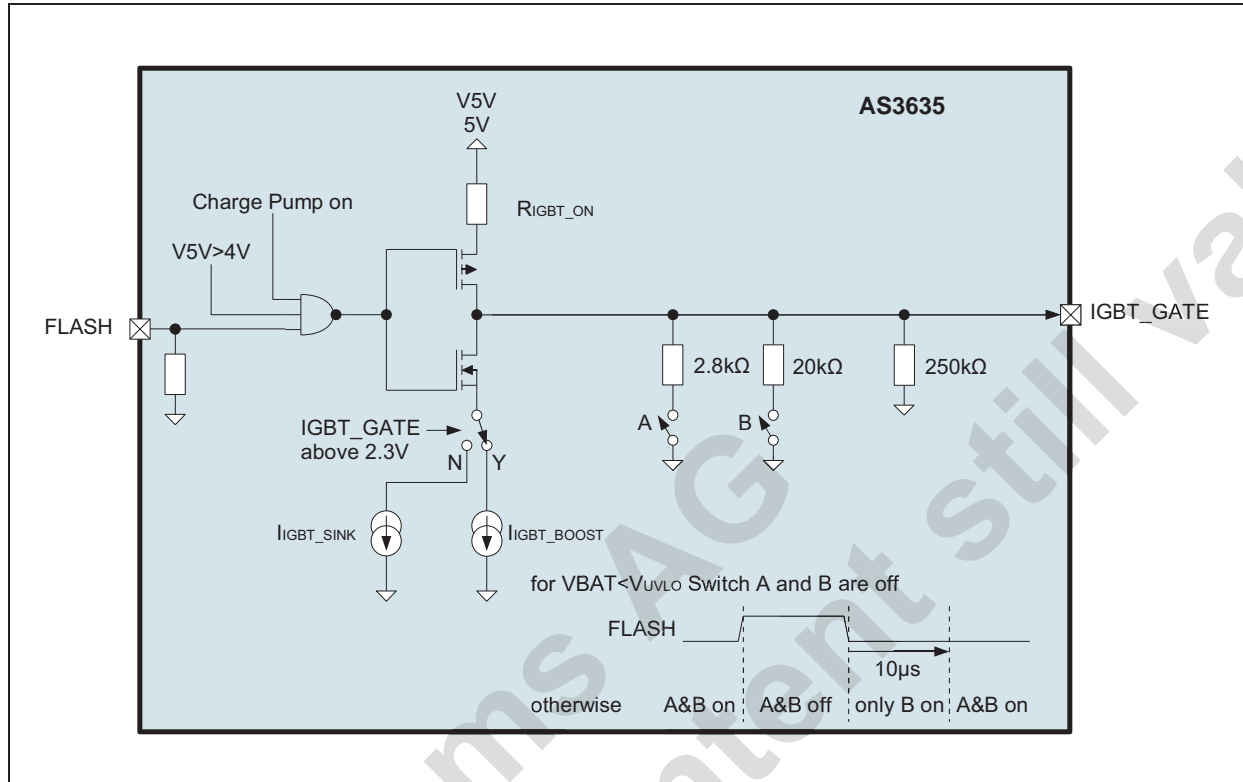

The IGBT driver is enable once the charge pump is switched on and the voltage on pin V5V has reached 4V (to guarantee at least 4V driving signal for the IGBT).

The IGBT driver includes all required resistors and pulldowns to operate the IGBT without any external circuitry<sup>3</sup>. Do not add any external pulldown resistor on pin IGBT\_GATE.

3. Exception: If the Sanyo IGBT TIG058E8 is used, add a series resistor of 50Ω for the gate drive. For Renesas RJP4006AGE add a series resistor of 68Ω.

## ESD Protection Diodes

The internal ESD diodes are shown in Figure 21 - do not operate ESD diodes in forward direction<sup>4</sup>:

Figure 21. ESD Diodes

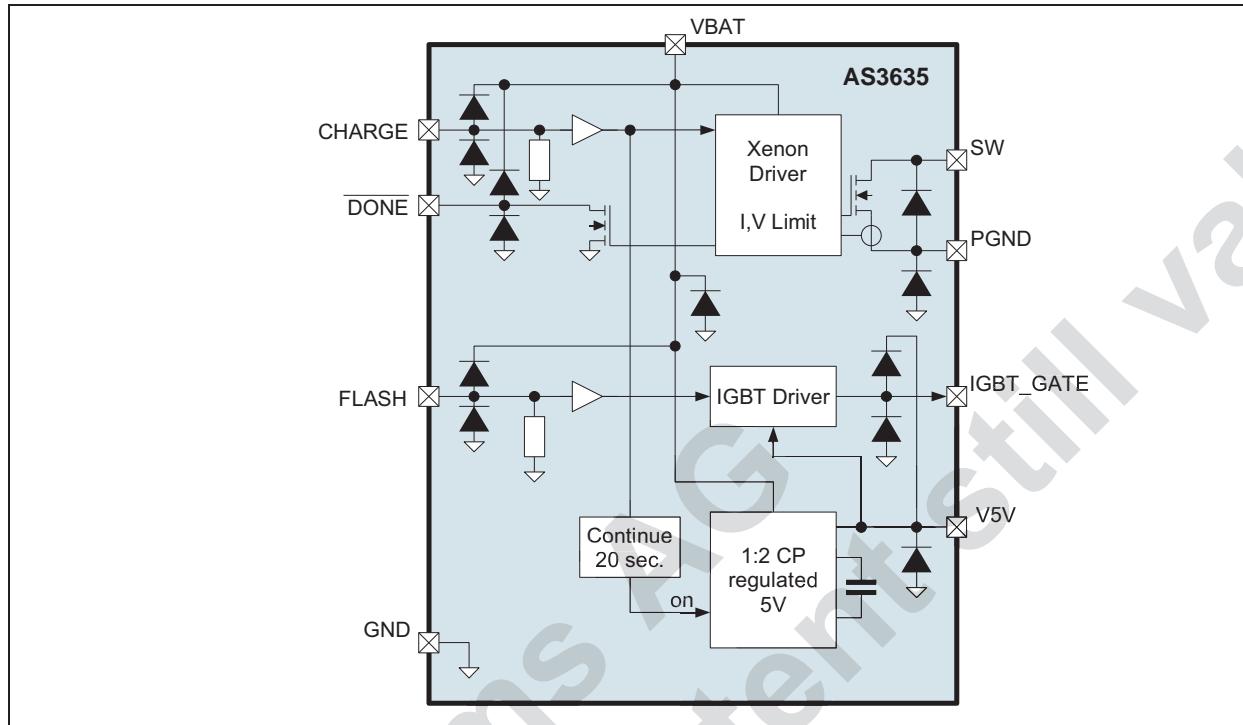

4. Exception: The diode between SW and PGND is designed to be operated in forward direction for very short pulses during charging.

## 9 Application Information

### External Components

#### Transformers $T_{\text{CHARGE}}$ and $T_{\text{TRIG}}$

Following transformers are recommend for the AS3635 (due to the OTP programming features see section [Trimming Procedure on page 12](#), the output voltage  $V_{\text{FLASH}}$  can be programmed):

Table 4. Recommended Transformers

Component	Part Number	N	L	Size (mm)	Manufacturer
$T_{\text{CHARGE}}$	C3-T2.5R	10.2	6.7 $\mu$ H	3.4x3.4x2.5	Mitsumi Electric <a href="http://www.mitsumi.co.jp">www.mitsumi.co.jp</a>
	TTRN-3825H	10.2	7 $\mu$ H	3.8x3.8x2.5	Tokyo Coil <a href="http://www.tokyo-coil.co.jp">www.tokyo-coil.co.jp</a>
	TTRN-3822H	10.2	7 $\mu$ H	3.8x3.8x2.2	
	TTRN-5820H	10.2	8.87 $\mu$ H	5.8x5.8x2.0	
	TTRN-0520H	10.41	8.35 $\mu$ H	5.0x5.0x2.0	
	LDT4520T-01	10.2	10 $\mu$ H	4.7x4.5x2.0	TDK <a href="http://www.tdk.com">www.tdk.com</a>
ATB322515	10.2	7 $\mu$ H	3.2x2.5x1.55 (H is max)		
$T_{\text{TRIG}}$	BO-02			7.3x2.5(3.5)x2.2	Tokyo Coil <a href="http://www.tokyo-coil.co.jp">www.tokyo-coil.co.jp</a>

Always check if the voltage on the pin SW does never exceed the AS3635 maximum  $V_{\text{sw}}$  (see [Table 3 on page 4](#)) specification during charging.

#### IGBT

As the AS3635 has an internal charge pump included, 2.5V, 2.7V and 4V IGBT can be used without limit on the supply  $V_{\text{BAT}}$ . The IGBT is used for two purposes:

1. Powering of the Xenon tube and generating together with the oscillation circuit consisting of  $T_{\text{TRIG}}$ ,  $C_{\text{TRIG}}$ ,  $R_{\text{TRIG}}$  a sufficiently high trigger pulse to ignite the Xenon tube (about 3.5kV) - this is accomplished by a fast rising edge of the gate of the IGBT
2. Switching off the current through the Xenon tube at the end of the flash pulse to accurately control the light emitted by the flash. To protect the IGBT the switching off falling edge voltage should be less than 400V/ $\mu$ s (measured on the emitter of the IGBT)

Both requirements are achieved with the internal driving circuit of the AS3635. Internal OTP trimming allows to adopt to different trigger coils and IGBTs.

Table 5. Recommended IGBTs

Component	Part Number	min. Drive Voltage	Size	Manufacturer
$Q_{\text{IGBT}}$	RJP4002ANS	2.5V	VSON-8 3 x 4.8mm	Renesas <a href="http://www.renesas.com">www.renesas.com</a>
	RJP4003ANS	4.0V		
	RJP4006AGE <sup>1</sup>	2.7V	2.85x3.05x1.1 mm (H is max.)	
	GT8G133	4.0V	TSSOP-8 3.3 x 6.4mm	Toshiba <a href="http://www.semicon.toshiba.co.jp">www.semicon.toshiba.co.jp</a>
	TIG058E8 <sup>2</sup>	4.0V	ECH8 2.8 x 2.9mm	Sanyo <a href="http://www.sanyo.com">www.sanyo.com</a>

1. Add a series resistor of 68 $\Omega$  in the gate drive.
2. Add a series resistor of 47 $\Omega$  in the gate drive.



### Photoflash Capacitor $C_{FLASH}$

The photoflash capacitor stores the energy for the flash. Its capacitance defines the maximum available energy. Using higher value capacitors as shown in Table 6 is possible, but will increase the charging time.

It is recommended to use low ESR capacitors to avoid losing power during flash (it is also possible to connect two capacitors in parallel to reduce ESR):

Table 6. Recommended Photoflash Capacitors

Component	Part Number	Capacitor	Voltage rating	Size	Manufacturer
$C_{FLASH}$	330FW13A6.3X20	2x13.5 $\mu$ F <sup>1</sup>	330V	Cylinder 2 x l=24mm, d=7mm	Rubycon <a href="http://www.rubycon.co.jp">www.rubycon.co.jp</a>

1. Different capacitor values are possible to be used together with the AS3635. Lower capacitor value will reduce charging time, lower ESR capacitor will improve light output energy and reduce losses in the capacitor during the flash pulse.

### Photoflash Charger rectification diode $D_{CHARGE}$

The rectification diode should have very low parasitic capacitance<sup>5</sup> and has to withstand the operating current and reverse voltages.

Table 7. Recommended Rectification Diodes

Component	Part Number	Parasitic Capacitor	Voltage rating	Size	Manufacturer
$D_{CHARGE}$	FVO2R80	5pF	800V	1.25x2.5mm	Origin <a href="http://www.origin.co.jp">www.origin.co.jp</a>
	GSD2004S	5pF / 2	2x240V	SOT-23 2.4x3.0mm	Vishay <a href="http://www.vishay.com">www.vishay.com</a>
	BAS21	5pF / 2	2x250V	SC-70 2.0x2.1mm	OnSemi <a href="http://www.onsemi.com">www.onsemi.com</a>

### Supply Capacitor $C_{VBAT}$ and charge pump capacitor $C_{V5V}$

Low ESR capacitors should be used to minimize VBAT ripple. Multi-layer ceramic capacitors are recommended since they have extremely low ESR and are available in small footprints. The capacitor should be located as close to the device as possible.

X5R dielectric material is recommended due to their ability to maintain capacitance over wide voltage and temperature range.

Table 8. Recommended  $C_{VBAT}$  and  $C_{V5V}$  Capacitor

Component	Part Number	C	TC Code	Rated Voltage	Size	Manufacturer
$C_{V5V}$	GRM155R60J474	470nF	X5R	6.3V	0402	Murata <a href="http://www.murata.com">www.murata.com</a>
	GRM155R60J105 GRM155R61A105	1 $\mu$ F	X5R	6.3V 10V	0402	
	$C_{VBAT}$	GRM188R60J475	4.7 $\mu$ F	X5R	6.3V	

If a different output capacitor is chosen, ensure low ESR values and voltage ratings.

5. A low parasitic capacitance improves charging efficiency.

## PCB Layout Guideline

Following layout recommendations apply:

1. Keep the path (and area) of GND - CVBAT - VBAT - TCHARGE(primary) - SW - GND as short as possible to minimize the leakage inductance of TCHARGE and ensure a proper supply connection for the AS3635
2. Place CVBAT as close as possible to the AS3635.
3. Ensure wide and short PCB paths for the path GND - CFLASH - XFLASH - QIGBT - GND to allow 150A to flow during the flash pulse. Connect this GND only at a single place to the main GND plane.
4. The IGBT has two ground connections: One ground for the driving input and one ground for the power path.
5. Ensure larger spacings for all high voltage paths; check with the PCB manufacturer to ensure proper minimum spacing for 320V paths and 4kV (Xenon tube trigger pin) paths.
6. Minimize the parasitic capacitance of the PCB on the anode of DCHARGE especially to GND and VFLASH
7. See austriamicrosystems "WLP-CSP-Handling-Guidelines\_1V0.pdf" for proper handling, PCB layout and soldering of the WL-CSP AS3635 device.

See austriamicrosystems demoboard layout (described in application note 'AN3635').

## 10 Package Drawings and Markings

Figure 22. 9 pin WL-CSP 1.5x1.5mm Marking

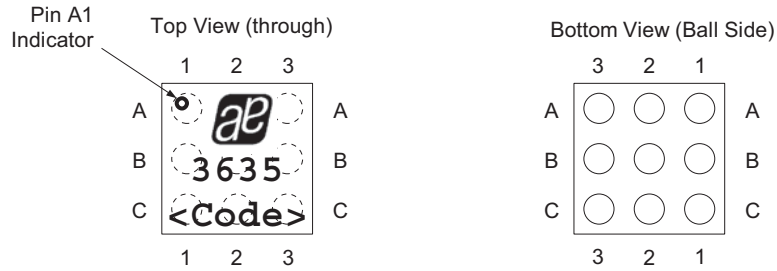

**Note:**

- Line 1: austriamicrosystems logo
- Line 2: 3635 and version code (e.g. 'A' or 'B')
- Line 3: <Code>  
Encoded Datecode (4 characters)

Figure 23. 9 pin WL-CSP 1.5x1.5mm Package Dimensions

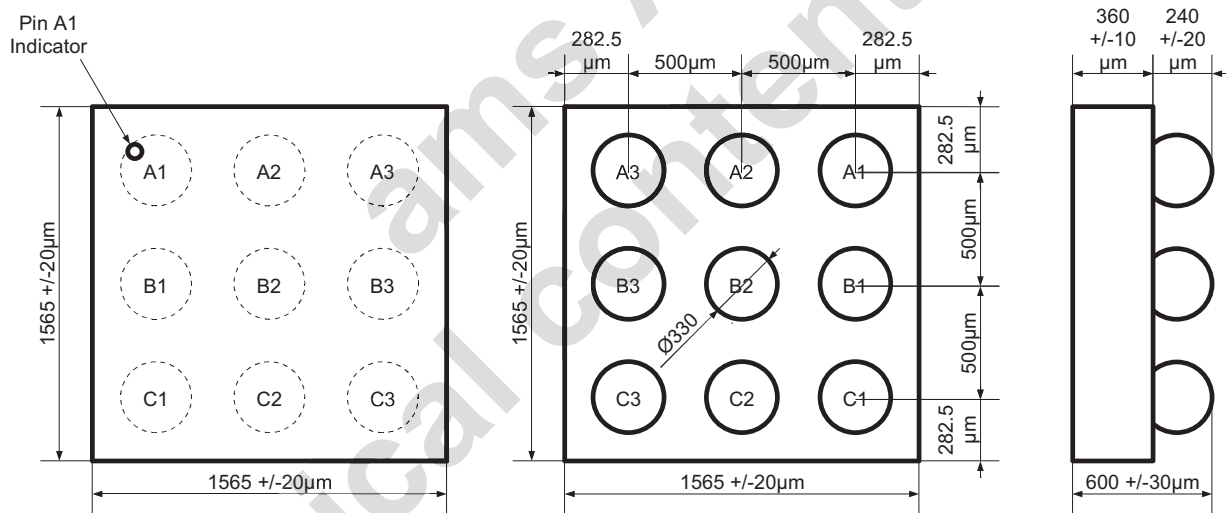

## 11 Ordering Information

The devices are available as the standard products shown in [Table 9](#).

Table 9. Ordering Information

Order Code	Marking	Description	Delivery Form	Package
AS3635B-ZWLT	3635B	Xenon Flash Driver with 5V IGBT Control Isw (charging current peak) = 900mA R <sub>IGBT_ON</sub> = 50Ω I <sub>IGBT_SINK</sub> = 15mA I <sub>IGBT_BOOST</sub> = 46mA V <sub>TRIP</sub> trimmed by customer	Tape & Reel	9-pin WL-CSP (1.5mm x 1.5mm) RoHS compliant / Green / Pb-Free
AS3635E-ZWLT	3635E	Xenon Flash Driver with 5V IGBT Control Isw (charging current peak) = 900mA R <sub>IGBT_ON</sub> = 15Ω I <sub>IGBT_SINK</sub> = 60mA I <sub>IGBT_BOOST</sub> = 46mA V <sub>TRIP</sub> trimmed by customer	Tape & Reel	9-pin WL-CSP (1.5mm x 1.5mm) RoHS compliant / Green / Pb-Free

**Note:** All products are RoHS compliant and austriamicrosystems green.  
 Buy our products or get free samples online at ICdirect: <http://www.austriamicrosystems.com/ICdirect>

Technical support is found at <http://www.austriamicrosystems.com/Technical-Support>

For further information and requests, please contact us <mailto:sales@austriamicrosystems.com>  
 or find your local distributor at <http://www.austriamicrosystems.com/distributor>

**Note:** AS3635-ZWLT

AS3635-

- B, E Version Code - see [Table 9](#) - 'Description'
- Z Temperature Range: -30°C - 85°C
- WL Package: Wafer Level Chip Scale Package (WL-CSP) 1.5x1.5mm
- T Delivery Form: Tape & Reel

## Copyrights

Copyright © 1997-2011, austriamicrosystems AG, Schloss Premstaetten, 8141 Unterpremstaetten, Austria-Europe. Trademarks Registered ®. All rights reserved. The material herein may not be reproduced, adapted, merged, translated, stored, or used without the prior written consent of the copyright owner.

All products and companies mentioned are trademarks or registered trademarks of their respective companies.

## Disclaimer

Devices sold by austriamicrosystems AG are covered by the warranty and patent indemnification provisions appearing in its Term of Sale. austriamicrosystems AG makes no warranty, express, statutory, implied, or by description regarding the information set forth herein or regarding the freedom of the described devices from patent infringement. austriamicrosystems AG reserves the right to change specifications and prices at any time and without notice. Therefore, prior to designing this product into a system, it is necessary to check with austriamicrosystems AG for current information. This product is intended for use in normal commercial applications. Applications requiring extended temperature range, unusual environmental requirements, or high reliability applications, such as military, medical life-support or life-sustaining equipment are specifically not recommended without additional processing by austriamicrosystems AG for each application. For shipments of less than 100 parts the manufacturing flow might show deviations from the standard production flow, such as test flow or test location.

The information furnished here by austriamicrosystems AG is believed to be correct and accurate. However, austriamicrosystems AG shall not be liable to recipient or any third party for any damages, including but not limited to personal injury, property damage, loss of profits, loss of use, interruption of business or indirect, special, incidental or consequential damages, of any kind, in connection with or arising out of the furnishing, performance or use of the technical data herein. No obligation or liability to recipient or any third party shall arise or flow out of austriamicrosystems AG rendering of technical or other services.



## Contact Information

### Headquarters

austriamicrosystems AG

Tobelbaderstrasse 30

Schloss Premstaetten

A-8141 Austria

Tel: +43 (0) 3136 500 0

Fax: +43 (0) 3136 525 01

For Sales Offices, Distributors and Representatives, please visit:

<http://www.austriamicrosystems.com/contact>