

ZMX Series 3D Time of Flight Sensor

Instruction Manual

Original Instructions
230551 Rev. C
9 February 2023
© Banner Engineering Corp. All rights reserved



230551

Contents

| | |
|---|-----------|
| 1 Product Description | 3 |
| 1.1 Models | 3 |
| 1.2 Features and Indicators | 3 |
| 1.3 Sample Application: Bin Fill | 3 |
| 1.4 Laser Description and Safety Information | 4 |
| 2 Installation Instructions | 6 |
| 2.1 Installation Best Practices | 6 |
| 2.2 Mount the Device | 6 |
| 2.3 Wiring | 7 |
| 2.4 Install the Software | 7 |
| 3 Getting Started | 9 |
| 3.1 Connect to the Sensor | 9 |
| 3.2 Set Up the ZMX Sensor | 9 |
| 4 Banner 3D Configuration Workspace | 11 |
| 4.1 Image Pane Parameters | 11 |
| 4.2 Connection Pane | 13 |
| 4.3 Sensor Controls Pane | 13 |
| 4.4 Fill Level Pane | 15 |
| 4.4.1 Discrete Output | 17 |
| 4.5 Communications Pane | 17 |
| 4.5.1 DHCP | 17 |
| 4.6 Sensor Maintenance Pane | 18 |
| 5 Specifications and Requirements | 19 |
| 5.1 Specifications | 19 |
| 5.2 FCC Part 15 Class A | 20 |
| 5.3 Industry Canada | 20 |
| 5.4 Performance Curves | 21 |
| 5.5 PC Requirements | 21 |
| 5.6 Dimensions | 22 |
| 5.7 Field of View Charts | 23 |
| 5.8 Factory Defaults | 23 |
| 6 Industrial Ethernet Overview | 25 |
| 6.1 EtherNet/IP™ | 25 |
| 6.1.1 Configuring the Sensor to use an Industrial Protocol | 25 |
| 6.1.2 ZMX Series EDS File Installation in ControlLogix Software | 26 |
| 6.1.3 EtherNet/IP Configuration Using Generic Ethernet Module | 31 |
| 6.1.4 Assembly Objects | 34 |
| 6.1.5 Controlling the ZMX Sensor | 38 |
| 6.2 Modbus® TCP | 39 |
| 6.2.1 Configuring the Sensor to use an Industrial Protocol | 40 |
| 6.2.2 Using Input Bits | 40 |
| 6.2.3 ZMX Sensor Output Values | 41 |
| 6.2.4 ZMX Sensor Input Values | 43 |
| 6.3 Troubleshooting | 44 |
| 6.3.1 Sensor Fault Codes | 44 |
| 6.3.2 Configuration Error Codes | 45 |
| 7 Accessories | 47 |
| 7.1 Cordsets | 47 |
| 7.2 Brackets | 47 |
| 8 Product Support | 48 |
| 8.1 Cleaning Instructions | 48 |
| 8.2 Back Up the Sensor | 48 |
| 8.3 Restore the Sensor | 48 |
| 8.4 Repairs | 48 |
| 8.5 Contact Us | 49 |
| 8.6 Banner Engineering Corp. Limited Warranty | 49 |
| 8.7 Banner Engineering Corp. Software Copyright Notice | 49 |

1 Product Description

Simple, reliable, volume and height monitoring with ZMX Series. Patent pending.



- 3D Time of Flight technology detects peak fill height and volume within a large field of view
- Fits many applications with adjustable sensing height and field of view
- Sensor monitors entire sensing region of interest, not a single point like an ultrasonic or laser sensor
- Completely self-contained, no controller or PC required
- Deploy in minutes with only a few settings to define
- Configurable sensing range up to 2.5 m for height monitoring
- Define sensor field of view to monitor specific area of interest
- Available in discrete and Pulse Pro outputs for simplified deployment; industrial Ethernet communications available to integrate with the Smart Factory
- Compact, rugged IP65 housing designed for industrial environments



WARNING:

- **Do not use this device for personnel protection**
- Using this device for personnel protection could result in serious injury or death.
- This device does not include the self-checking redundant circuitry necessary to allow its use in personnel safety applications. A device failure or malfunction can cause either an energized (on) or de-energized (off) output condition.

1.1 Models

| Models | Resolution | Field of View | Range |
|------------------|------------------|-----------------|--------------------------------------|
| ZMX-3DE2500HF-Q7 | 272 × 208 pixels | 60 × 45 degrees | 200 mm to 2500 mm (7.9 in to 8.2 ft) |

1.2 Features and Indicators

LED indicators provide ongoing indication of sensing status.

Figure 1. Features

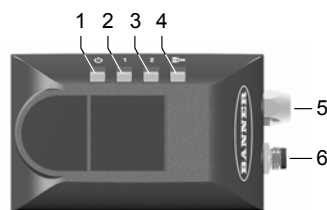

1. Power and Fault LED (off, green, red, or flashing red)
2. Ready LED
3. Image Transmitted LED
4. Ethernet Activity LED
5. Ethernet connection
6. Power connection

1.3 Sample Application: Bin Fill

Use the ZMX Series in a variety of applications.

- Gaylord volume fill level monitoring at a material handling facility
- Continually monitoring the height of packages in a shipping container
- Level monitoring of consumer or grocery items in a tote
- Determine if an item is protruding over the top of a bin
- Detect overflow of items within a defined region of interest

When boxes or other solid objects are collected in a bin, the true amount of space consumed is not accurately measured by measuring the height at any one point. Inconsistent shapes and uneven stacking are common, leaving an uneven top surface. Many other types of distance measurement sensors can give inconsistent readings. Sometimes their measurements vary based on whether they hit a top surface object or a hole between objects. The ZMX sensor measures distance over a

large rectangular area and calculates a fill level as well as peak height of the whole area, allowing better control of how the bin space is used and preventing overflow.

Figure 2. ZMX Sensor and Tower Light At the Bottom of a Chute



Container monitoring in three simple steps, up and running within minutes.

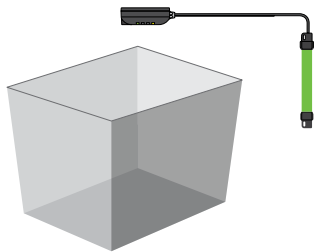

Step 1—Mount and connect to sensor – mounting is ultra-simple with built-in mounting holes or a variety of mounting brackets to choose from. Once mounted, connect the cables and begin communicating with Banner Banner 3D Configuration software.

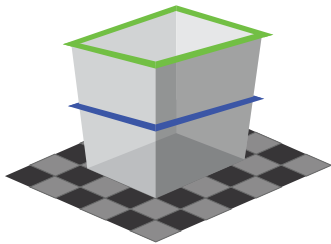

Step 2—Define Sensing Conditions – only a few inputs need to be defined for the sensor to accurately monitor container height. Start by defining the anchor point for measurements at the bottom of the container, then define the size of the sensing region of interest. Finally, choose the sensing criteria for the application such as peak height or volume.

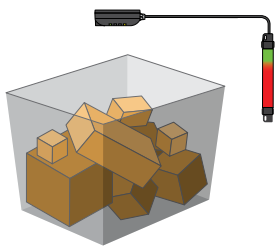

Step 3—Monitor fill level – Once mounted and configured, the sensor is completely self-contained and does not require any external controllers or PC. Begin sensing and integrate with chosen PLC, controller, or indication light.

1.4 Laser Description and Safety Information



CAUTION:

- **Return defective units to the manufacturer.**
- Use of controls or adjustments or performance of procedures other than those specified herein may result in hazardous radiation exposure.
- Do not attempt to disassemble this sensor for repair. A defective unit must be returned to the manufacturer.

Class 1 lasers are lasers that are safe under reasonably foreseeable conditions of operation, including the use of optical instruments for intrabeam viewing.

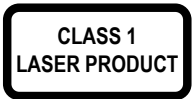

Complies with 21 CFR 1040.10 and 1040.11, except for deviations pursuant to Laser Notice No. 56, dated May 8, 2019.

Complies with IEC 60825-1:2014 and EN 60825-1:2014+A11:2021.

2 Installation Instructions

2.1 Installation Best Practices

The following diagrams show best practices for installing the ZMX sensor.

Figure 3. Sensor Height

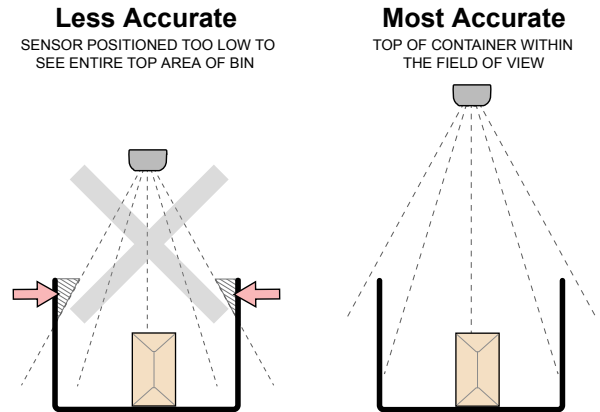

For accurate fill levels, position sensor higher up and centered over container.

Figure 4. Minimize Blind Spots

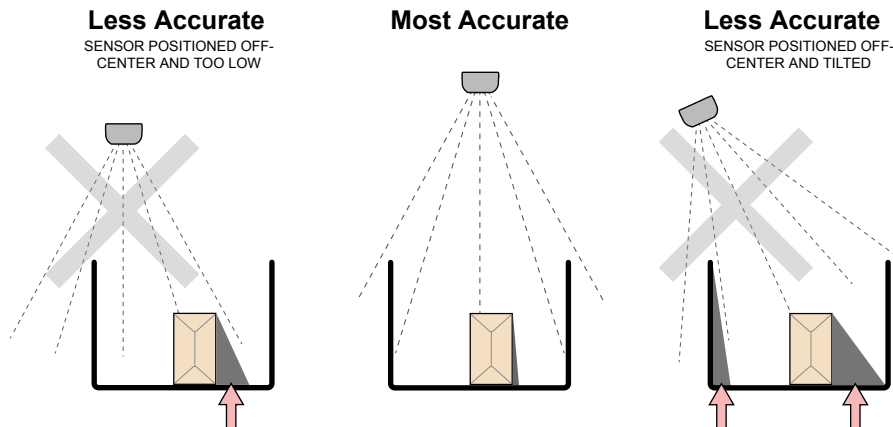

Minimize the potential for blind spots by positioning sensor higher up and centered over container.

2.2 Mount the Device

1. If a bracket is needed, mount the device onto the bracket.
2. Mount the device (or the device and the bracket) to the machine or equipment at the desired location. Do not tighten the mounting screws at this time.



CAUTION: This device accepts M4 screws. Engaging the screws more than 4 mm will damage the device.



CAUTION: 8 in·lbf (0.904 Nm) maximum torque

3. Check the device alignment.

- Tighten the mounting screws to secure the device (or the device and the bracket) in the aligned position.

Figure 5. Mounting Holes

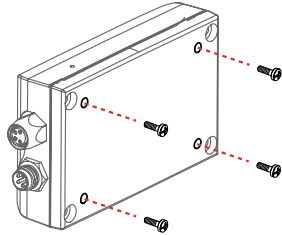

Note: Do not remove the housing screws.



Note: Provide adequate dissipation of heat. A good heat conductor, such as aluminum, may be required.

| Mounting Surface Thickness | Length of Mounting Screws |
|----------------------------|---------------------------|
| ≤ 2 mm | 4 mm |
| 2 mm to 4 mm | 6 mm |
| 4 mm to 6 mm | 8 mm |

2.3 Wiring

To maintain the ratings listed in the Specifications, use cables with shields.

Tighten the cables finger tight only.

Figure 6. Channel 1 as PNP Output, Channel 2 as Trigger Input

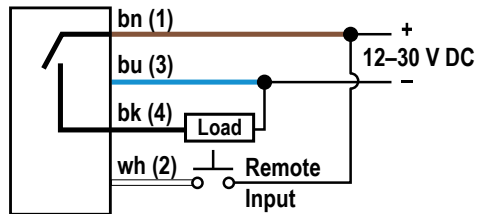

Figure 7. Channel 1 as NPN Output, Channel 2 as Trigger Input

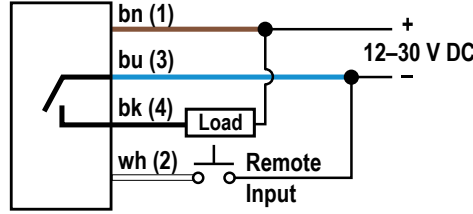

Figure 8. M8 Male Connector

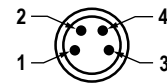

Table 1: Power and I/O Pinouts

| Pin | Wire Color | Description |
|-----|------------|---|
| 1 | Brown | 12 V DC to 30 V DC |
| 2 | White | Trigger Input or Output (selectable PNP, NPN, or push-pull) |
| 3 | Blue | Common |
| 4 | Black | Output (selectable PNP, NPN, or push-pull) |

2.4 Install the Software

Use the following instructions to install the Banner 3D Configuration software on your computer.



Important: Administrative rights may be required to install the Banner 3D Configuration software.

- Download the latest version of the software from www.bannerengineering.com.
- Navigate to and open the downloaded file.
- Run the downloaded installer.
- Check the agreement for license terms and conditions.

5. Click **Install** to install the software.
A Windows security message displays. This indicates that the installer is signed and is from Banner.
6. Click **Yes**.
7. Click **Close** to exit the installer when the installation is complete.
8. Locate the program icon on the desktop or in the **Start** menu and open the Banner 3D Configuration software.

3 Getting Started

3.1 Connect to the Sensor

These instructions use Windows® operating system version 8, 10, or 11.³

1. Confirm the network connections.
 - a) Click the **Start** button, then on the **Start** menu, click **Control Panel**.
 - b) In **Control Panel**, click **Network and Internet**, then click **Network and Sharing Center**, and then click **Change adapter settings**.
 - c) Right-click on the connection that you want to change, then click **Properties**.
If you are prompted for an administrator password or confirmation, enter the password or provide confirmation.
 - d) In the connection properties, click **Internet Protocol Version 4 (TCP/IPv4)**, and then click **Properties**.

Figure 9. Local Area Connection Properties

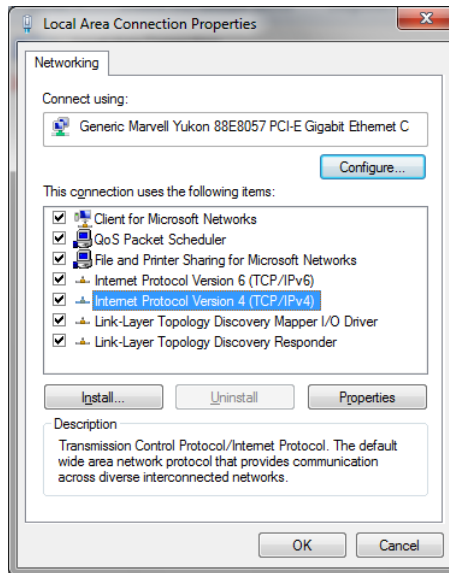

- e) In the **Internet Protocol (TCP/IPv4) Properties**, select **Use the following IP address**.
 - f) Make sure that the IP address is 192.168.0.2 (or an unused IP address within the 192.168.0.x subnet), and the subnet mask is 255.255.255.0.
2. Open the Banner 3D Configuration software from the desktop or the **Start** menu.
 3. Connect to the ZMX sensor using one of the following options:
 - From the **Connection** pane, enter the IP address of the desired ZMX sensor into the **Sensor IP Address** field, then click **Connect**.
 - From the **Connection** pane, locate the IP address of the desired sensor in the list of discovered sensors, then click  next to **IP Address**.

The default IP address for the sensor is 192.168.0.10.

3.2 Set Up the ZMX Sensor

Use the following basic steps to set up an application in the Banner 3D Configuration software.

1. Make sure the container is in place and is empty.
2. Adjust the pitch/roll/yaw if an angle correction is needed.
See [Sensor Controls Pane](#) on page 13.
3. From the **Amplitude** view, click in the center of the container.
A green cursor displays in the center of the container and the coordinates of the cursor are shown in the lower right.
4. Copy the X, Y, and Z coordinates from the lower right of the **Image** pane into the **Anchor Point X, Y, and Z** fields in the **Fill Level** pane.

³ Windows is a registered trademark of Microsoft Corporation in the United States and/or other countries.

5. Enter the dimensions of the container (in mm) in the **Size** field.

It is best practice to use slightly smaller X and Y measurements than the inner dimensions of the container.
The white box in the view updates in size.



Note: If the box is not visible, click .

6. Enter the desired **Fill Level** and **Peak Height** limits.
The lines on the **Fill** and **Peak** bar graphs update.



Note: Allow the sensor to warm up for 15 minutes to ensure optimal sensor performance.

4 Banner 3D Configuration Workspace

The Banner 3D Configuration software displays the information needed to modify sensor parameters.

Figure 10. Banner 3D Configuration Software

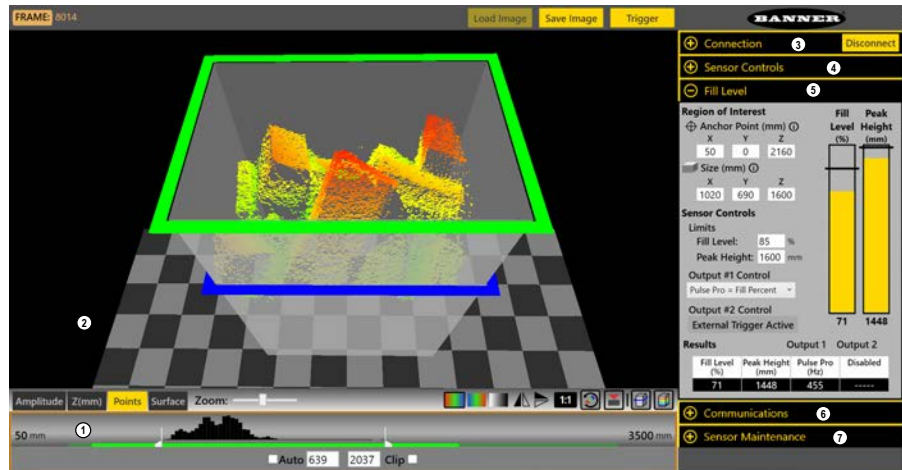

The workspace is divided into several panes.

1. **Image Pane Parameters**—Includes zoom; x, y, z coordinates; image color; view selection (Amplitude, Z(mm), Points, Surface). The options vary depending on the selected view. See [Image Pane Parameters](#) on page 11.
2. **Image pane**—Displays the current image captured by the sensor and includes the buttons:
 - **Load Image**—Loads a previously saved file for viewing while disconnected from the sensor
 - **Save Image**—Save file as a .t3f
 - **Trigger**—Manually triggers the sensor when Trigger mode is set to **External** or **Software**
3. **Connection pane**—Enables connection to a sensor and includes settings and information related to the sensor's IP address. See [Connection Pane](#) on page 13.
4. **Sensor Controls pane**—Controls the trigger mode and illumination output. See [Sensor Controls Pane](#) on page 13.
5. **Fill Level pane**— Includes options for the region of interest and sensor controls, as well as live fill and peak height data. See [Fill Level Pane](#) on page 15.
6. **Communications pane**—Sets the communication protocol and DHCP option for the sensor. See [Communications Pane](#) on page 17.
7. **Sensor Maintenance pane**—Includes sensor information and options to update the firmware, restore the sensor to the default settings, to backup the current sensor settings, or restore the sensor to previously saved settings. See [Sensor Maintenance Pane](#) on page 18.

4.1 Image Pane Parameters

Use the **Image Pane Parameters** to change how the Image pane displays.

Figure 11. Image Pane Parameters

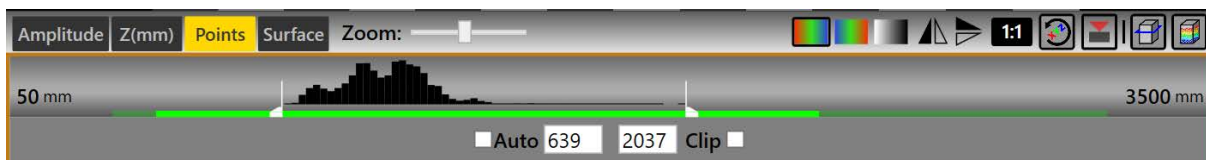

Click a view selection button to change the view and the available options:

Amplitude

Shows a top down 2D pseudo-grayscale image of the container.

Z(mm)

Shows a top down 2D color-coded Cartesian Z image of the container.

Points

Shows the individual measurement points in 3D.

Surface

Shows a smoothed out view of the measurement points in 3D.

When using either the **Points** view or the **Surface** view, left-click, hold, and drag inside the image pane to rotate the image three-dimensionally. Right-click, hold, and drag to move the image horizontally and vertically.

The histogram graph in the center of the Image Pane Parameters graphically displays the distribution of pixels in the current image on a scale of amplitude or Z distance, depending on the current view. The white bars can be adjusted left or right to adjust the shading of the pixels. The histogram is available in all views. The specified operating distance of the sensor is colored green. A portion of the green bar is a lighter shade of green. The sensor may still return data from this region, but it may not adhere to the stated accuracy specifications of the device. The green bar is available in **Z(mm)**, **Points**, and **Surface** views.

Use the **Auto** checkbox to automatically scale the pixels to view the entire field of view. When checked, the white shading control bars are adjusted for each image to start the shading range just before the left-most pixels, and end the shading range after the right-most pixels in the histogram.

Use the **Clip** checkbox to change what is outside of the histogram graph markers to purple (**Amplitude** and **Z(mm)** views) or to disappear (**Points** and **Surface** views) to indicate that these areas are not of interest.

The two numbers between the **Auto** and **Clip** checkboxes show the locations of the two white markers in the histogram graph. These markers can be dragged to the desired location.



Red is Near, Blue is Far—Displays objects closest to the sensor as red, while objects further from the sensor display as blue. Objects between these points display in various colors, depending on their distance from the sensor. Available in **Z(mm)**, **Points**, and **Surface** views.



Blue is Near, Red is Far—Displays objects closest to the sensor as blue, while objects further from the sensor display as red. Objects between these points display in various colors, depending on their distance from the sensor. Available in **Z(mm)**, **Points**, and **Surface** views.



Grayscale Overlays Distance—Changes the image color scheme to grayscale. Available in **Z(mm)**, **Points**, and **Surface** views.



Horizontal Flip Mode—Changes the view to a horizontal mirror image of the true view—the objects that were on one side of the view are now shown on the other side. Available in all views.



Vertical Flip Mode—Changes the view to a horizontal mirror image of the true view - the objects that were on one side of the view are now shown on the other side—what was showing on the top of the screen is now showing on the bottom of the screen. Available in all views.



Bubble Level On/Off—Shows or hides a level on screen at the cursor location that updates as the sensor is tilted. Available in **Amplitude** and **Z(mm)** views. Default is off.



Image Center Crosshairs On/Off—Shows or hides crosshairs that indicate the center of the field of view of the sensor. Available in **Amplitude** and **Z(mm)** views. Default is off.



Toggle 3D point cloud display decimation levels—Changes the size of the points shown. Available in **Points** and **Surface** views. Does not change image acquisition parameters. Default is 2:1.



Show or hide the 3D camera—Shows or hides the position of the sensor over the container as well as the field of view. Available in **Points** and **Surface** views. Default is hidden.



Hide or show the application working volume sidewalls—Shows or hides the user-defined boundaries of the container. This view also shows two colored boxes. The first is the Z-height setting shown as a green box. This box turns to red when the peak height is reached. The second is the fill level shown as a blue box that moves as the container is filled or emptied. Available in **Points** and **Surface** views. Default is show.



Hide or show all points outside of the application 3D Space—Show or hide objects that are within the field of view of the sensor but are located outside of the defined boundaries of the container. Available in **Points** and **Surface** views. Default is show.



Reset 3D camera view—Resets the 3D view to the default X, Y, and Z positions.

Coordinates in the Amplitude and Z(mm) Views—The following display in the lower right in the Amplitude view.

Amp

Brightness level of the selected pixel. The Amplitude range is 10 to 3000.

X(mm)

Horizontal distance from the surface visible in the selected pixel to the center of the image, along the X axis.

Y(mm)

Horizontal distance from the surface visible in the selected pixel to the center of the image, along the Y axis.

Z(mm)

Depth from the surface visible in the selected pixel to the face of the sensor.

Cursor(x,y)

Pixel coordinates of the selected pixel on the image sensor chip.

4.2 Connection Pane

Use the **Connection** pane parameters to change the sensor IP address and to connect to the sensor.

Figure 12. Sensor Pane

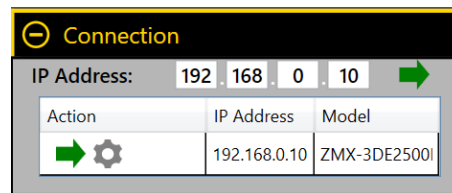

The default IP address for the ZMX sensor is 192.168.0.10.

The Banner 3D Configuration software remembers the IP address of the last connected sensor. The software also searches the local Ethernet subnetwork to find any available sensors. These sensors are listed in the **Connection** pane.

Hover over to view sensor name, serial number, MAC address, Gateway, firmware version, etc. To change a sensor's IP address, click .

To connect to a sensor, enter the IP address of the desired ZMX sensor into the **Sensor IP Address** field, then click next to the IP address. Alternately, locate the IP address of the desired sensor in the list of discovered sensors, then click in the **Action** column.

The model number of the sensor also displays.

To disconnect from a sensor, click .

Click to reboot a connected sensor.

4.3 Sensor Controls Pane

Use the **Sensor Controls** pane parameters to set the trigger mode and illumination output.

Figure 13. Sensor Controls Pane

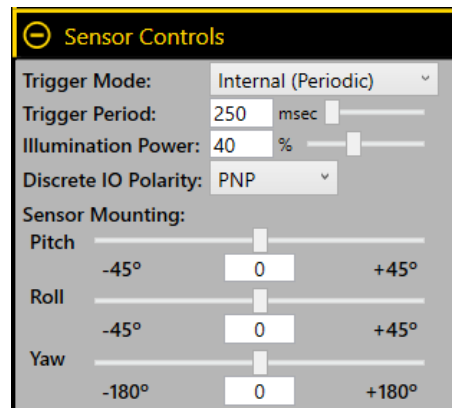

Trigger Mode

The **Trigger Mode** drop-down menu displays both the name for a given trigger mode and additional information in parentheses. There are four trigger modes for the sensor:

- **External (White Wire)**—In External trigger mode the sensor waits for a discrete input signal to arrive via the dedicated trigger input wire. The trigger is defined as the rising edge of a PNP signal. The software **Trigger** button also provides a sensor trigger while in this mode.
- **Internal (Periodic)**—In Internal trigger mode the sensor triggers at a user-defined Trigger Interval (from 200 milliseconds to 10,000 milliseconds). The software **Trigger** button also provides a sensor trigger while in this mode. In this mode, it is possible to provide triggers at a rate faster than the sensor can act on them. See the missed trigger count value available via an industrial protocol connection.
- **Free Run**—In Free Run trigger mode the sensor triggers as fast as possible. When a software connection is present, after one image is taken and transmitted to the software, the sensor moves immediately to take the next. When no connection is present, the sensor uses a 125 millisecond delay between triggers to simulate the image transfer time delays and avoid overheating.
- **Software (Protocols)**—In Software trigger mode the sensor is triggered by via an industrial protocols connection. The Banner 3D Configuration software **Trigger** button also provides a sensor trigger while in this mode.

Trigger Period

The time between each trigger. Use the slider or enter the desired trigger period in milliseconds. Available for **Internal (Periodic)** trigger modes.

Illumination Power

Control the illumination power of the sensor. Targets that are dark or farther away require higher illumination power. Use the slider or enter the desired power as a percentage. The default is 40%.

Discrete IO Polarity

Select

- **PNP**
- **NPN**
- **Push-Pull**

Sensor Mounting

Adjust the view of the sensor using the following controls.

Pitch—Adjust the up-and-down view of the sensor. The view (angle) setting is in degrees.

Roll—Adjust the view of the sensor along the longitudinal axis. The view (angle) setting is in degrees.

Yaw—Adjust the side-to-side view of the sensor. The view (angle) setting is in degrees.

Figure 14. Pitch, Roll, Yaw Diagram

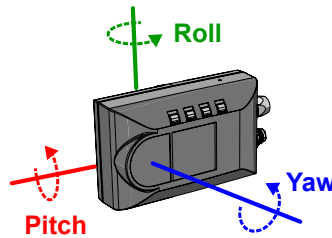

4.4 Fill Level Pane

Use the **Fill Level** pane to set the parameters for the region of interest (ROI) and to view live estimated fill and peak information.

Figure 15. Fill Level Pane

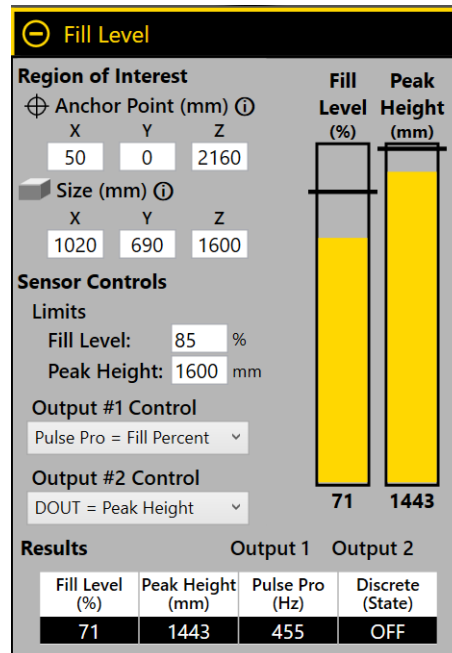

Fill Level (%)

This bar displays live information regarding the estimated volume percent of the objects in the container. The line corresponds to the set Fill Level Limit. The number below the bar is the estimated percent full.

Peak Height (mm)

This bar displays live information regarding the estimated height of the tallest point in the container. The line corresponds to the set Peak Height Limit. The number below the bar is the measured height in millimeters.

Region of Interest

Anchor Point (mm)—Define the X, Y and Z points of the sensor region of interest. From the **Z(mm)** view (Image Pane parameters), click the center of the container region of interest. Record the X(mm), Y(mm), and Z(mm) values from the software. These represent the bottom of the container. Pay attention to positive and negative values.

Figure 16. Anchor Point Diagram

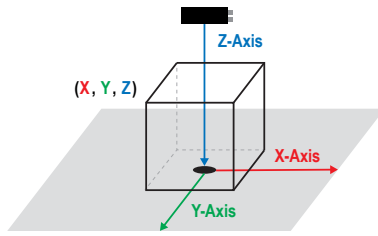

X = Center X point of container
 Y = Center Y point of container
 Z = The Z measurement from the bottom, or furthest point, of the container

Size (mm)—Define the length, width, and height of the container region of interest. The entire region of interest should be contained within the walls of the container.

Figure 17. Dimensions Diagram

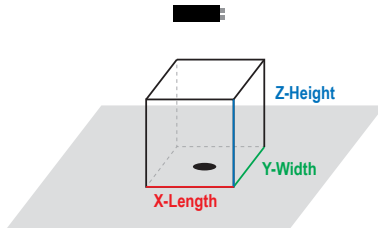

X = X-Length size dimension
 Y = Y-Width size dimension
 Z = Z-Height of container or desired detection limit

Sensor Controls

Limits—Fill Level: The threshold percentage that activates the Fill Level Limit Output.

Limits—Peak Height: The threshold height, in millimeters, that activates the Peak Height Limit Output.

Output #1 Control and Output #2 Control—The desired sensor outputs being exported; for more information, see [Discrete Output](#) on page 17.

Disabled

DOUT = Fill Percent

DOUT = Peak Height

DOUT = Fill or Peak

Pulse Pro = Fill Percent

Pulse Pro = Peak Height

Output 2 is disabled when the external trigger is enabled. "External Trigger Active" shows in **Output #2 Control** when this occurs.

Results

Fill Level (%): The percentage of volume filled within the ROI.

Peak Height (mm): The peak height within the ROI.

Output 1: Varies depending on what is selected from the **Output #1 Control** list.

Discrete Out

Pulse Pro (Hz): The Pulse Pro frequency from 100 Hz to 600 Hz.

Not Used

Output 2: Varies depending on what is selected from the **Output #2 Control** list. Output 2 is disabled (not used) when the external trigger is enabled.

Discrete Out

Pulse Pro (Hz): The Pulse Pro frequency from 100 Hz to 600 Hz.

Not Used

4.4.1 Discrete Output

The sensor can generate pulses whose frequency are proportional to the sensor's measured Fill Level or Peak Height, thereby providing a method for representing an analog signal with only a discrete counter.

When Output Control is set to **Pulse Pro = Fill Level**, the pulse frequency is scaled from 100 Hz at 0% full and 600 Hz at 100% full. When Output Control is set to **Pulse Pro = Peak Height**, the pulse frequency is scaled from 100 Hz at 0 mm peak height and 600 Hz at peak height equal to the height of the region of interest.

4.5 Communications Pane

Use the **Communications** pane parameters to select the industrial protocol.

Figure 18. Communications Pane

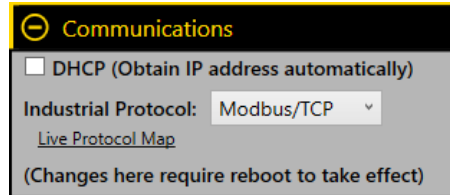

DHCP (Obtain IP address automatically)

Select this checkbox to enable Dynamic Host Control Protocol (DHCP). For additional information, see [DHCP](#) on page 17.

Industrial Protocol

Select the desired industrial protocol from the list.

- Off
- EtherNet/IP
- Modbus/TCP

Note that any changes to the parameters in this pane require a sensor reboot to take effect.

To view live industrial protocol data, click **Live Protocol Map**.

4.5.1 DHCP

This option allows a Dynamic Host Control Protocol (DHCP) client (for example, the ZMX sensor) to obtain its IP address, subnet, and gateway from a DHCP Server.

For this feature to work, the following criteria must be met:

1. The DHCP server is running, configured properly, and connected to the same network as the ZMX sensor.
 - a. Often the DHCP server is embedded into a router, smart switch or other industrial IT network equipment.
 - b. Banner does not provide this hardware or server software.
2. The ZMX sensor is connected by Ethernet cable to a location that has a running DHCP server.
3. The ZMX sensor is powered on.
 - a. The sensor continues to request its DHCP network settings up to approximately two minutes.
 - b. During the request period, the ZMX is not reachable and will not show up on the Banner 3D Configuration software discovered sensors list.
 - c. If the DHCP server provides network settings within the timeout period:
 - a. The sensor is reachable as a network device.
 - b. The DHCP network settings are not saved.
 - d. If the DHCP server fails to provide the network settings within the timeout period:
 - a. The sensor goes to the "Auto-IP" address, which will be in the range of 169.254.*.*
 - b. The sensor is available at this new, temporary IP address.
 - c. Reboot the ZMX sensor to repeat the DHCP IP address assignment process.

4.6 Sensor Maintenance Pane

Use the **Sensor Maintenance** pane to update the firmware, restore to factory default settings, and backup or restore the sensor.

Figure 19. Sensor Maintenance Pane

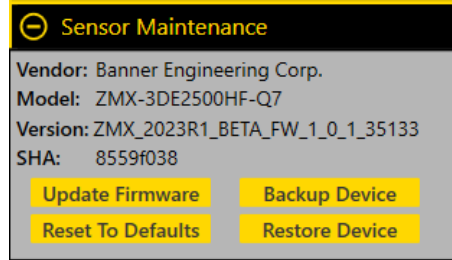

Click the desired option and follow the prompts to complete the action.

5 Specifications and Requirements

5.1 Specifications

Sensing Range

200 mm to 2500 mm (7.9 in to 8.2 ft) on a 90% reflectance white target
 200 mm to 2500 mm (7.9 in to 8.2 ft) on a 20% reflectance gray target
 200 mm to 1700 mm (7.9 in to 5.6 ft) on a 6% reflectance black target

Supply Voltage

12 V DC to 30 V DC
Current: 200 mA average, 2.5 A peak (exclusive of load and lights)
 Use only with a suitable Class 2 power supply, or current-limiting power supply rated 12 V DC to 30V DC, 2.5 A

Discrete I/O Configuration

Channel 1: Push-pull, PNP or NPN discrete output, or Pulse Pro/Pulse Frequency Modulation (PFM) output
 Channel 2: PNP or NPN discrete output, or Pulse Pro/Pulse Frequency Modulation (PFM) output, or remote trigger

Flatness (Pixel-to-Pixel Accuracy)

±20 mm for > 10x excess gain
 ±60 mm for 2x to 10x excess gain

Response Time

150 ms in Free Run mode

Accuracy

±30 mm for > 10x excess gain ⁴

Repeatability (1-sigma)

Peak excess gain: 2 mm
 >10x excess gain, 10 mm
 >2x excess gain, 40 mm

Communication Interface

Ethernet; 100 Mbps

Communication Protocol ⁵

Modbus[®] TCP/IP
 EtherNet/IP[™]

Boresighting

±20 mm at 1 m range

Delay at Power Up

< 10 s

Recommended Warm Up Time

15 minutes

Output Rating

Current rating: 50 mA maximum

| White wire specifications per configuration | | |
|---|-------------|-------------------------|
| PNP | Output High | ≥ Vsupply – 2.5 V |
| | Output Low | ≤ 2.5 V (loads ≤ 70 kΩ) |
| NPN | Output High | ≥ Vsupply – 2.5 V |
| | Output Low | ≤ 2.5 V |

Light Source

Infrared, 850 nm

Temperature Effect

< 0.5 mm/°C

Resolution

272 horizontal × 208 vertical pixels

Field of View

60 horizontal × 45 vertical degrees

Reading Rate, Full Resolution

Up to 6 frames per second in Free Run mode

Ambient Light Immunity

10,000 lux

Torque—Tapped Holes for Mounting Screws

8 in-lbf (0.904 Nm) maximum torque

Torque—Cables

Finger tighten only

Construction

Housing: Aluminum
 Lens Cover: Acrylic with optical coating
 Light Pipe: Polycarbonate

Connections

4-pin M8 male for power and discrete I/O
 4-pin M8 female for Ethernet

Storage Conditions

–30 °C to +65 °C (–22 °F to +149 °F)

Operating Conditions

–10 °C to +40 °C (+14 °F to +104 °F), assuming adequate mounting and ventilation

Environmental Rating

IP65 per IEC60529

Vibration

MIL-STD-202G, Method 201A (Vibration: 10 Hz to 55 Hz, 0.06 inch (1.52 mm) double amplitude, 2 hours each along X, Y and Z axes), with device operating

Shock

MIL-STD-202G, Method 213B, Condition I (100G 6x along X, Y, and Z axes, 18 shocks), with device operating

Weight

205 g

⁴ • For 6% to 90% diffuse targets in the center 25% of the field of view.
 • ±60 mm accuracy for 2x to 10x excess gain.

⁵ Modbus[®] is a registered trademark of Schneider Electric USA, Inc. EtherNet/IP[™] is a trademark of ODVA, Inc.

Required Overcurrent Protection



WARNING: Electrical connections must be made by qualified personnel in accordance with local and national electrical codes and regulations.

Overcurrent protection is required to be provided by end product application per the supplied table. Overcurrent protection may be provided with external fusing or via Current Limiting, Class 2 Power Supply. Supply wiring leads < 24 AWG shall not be spliced. For additional product support, go to www.bannerengineering.com.

| Supply Wiring (AWG) | Required Overcurrent Protection (Amps) |
|---------------------|--|
| 20 | 5.0 |
| 22 | 3.0 |
| 24 | 2.0 |
| 26 | 1.0 |
| 28 | 0.8 |
| 30 | 0.5 |

Certifications



EtherNet/IP



Banner Engineering BV Park Lane, Culliganlaan 2F bus 3, 1831 Diegem, BELGIUM



Turck Banner LTD Blenheim House, Blenheim Court, Wickford, Essex SS11 8YT, Great Britain

Advanced Capabilities



5.2 FCC Part 15 Class A

This equipment has been tested and found to comply with the limits for a Class A digital device, pursuant to part 15 of the FCC Rules. These limits are designed to provide reasonable protection against harmful interference when the equipment is operated in a commercial environment. This equipment generates, uses, and can radiate radio frequency energy and, if not installed and used in accordance with the instruction manual, may cause harmful interference to radio communications. Operation of this equipment in a residential area is likely to cause harmful interference in which case the user will be required to correct the interference at his own expense.

5.3 Industry Canada

This device complies with CAN ICES-3 (A)/NMB-3(A). Operation is subject to the following two conditions: 1) This device may not cause harmful interference; and 2) This device must accept any interference received, including interference that may cause undesired operation.

Cet appareil est conforme à la norme NMB-3(A). Le fonctionnement est soumis aux deux conditions suivantes : (1) ce dispositif ne peut pas occasionner d'interférences, et (2) il doit tolérer toute interférence, y compris celles susceptibles de provoquer un fonctionnement non souhaité du dispositif.

5.4 Performance Curves

Figure 20. Excess Gain

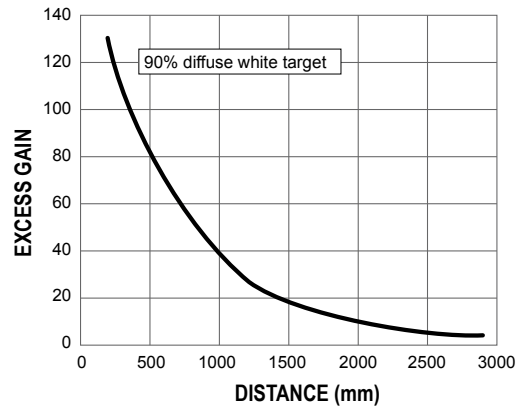
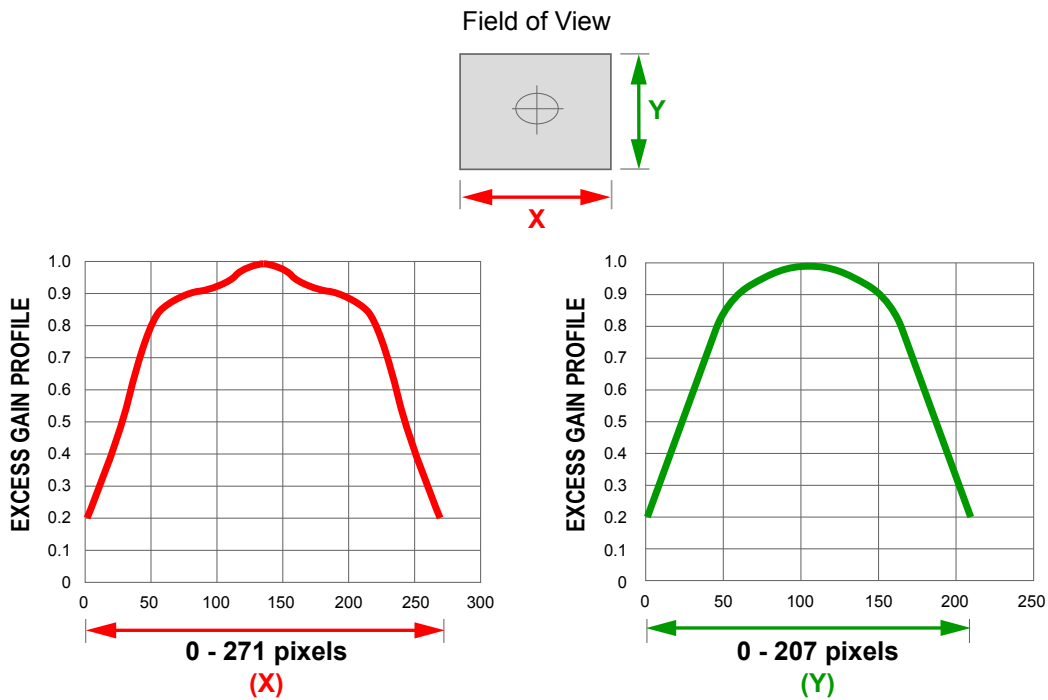

Figure 21. Excess Gain Profile



5.5 PC Requirements

Operating System

Microsoft® Windows® operating system version 8, 10, or 11 ⁶

Hard Drive Space

100 MB

Screen Resolution

1024 × 768 pixels

Memory (RAM)

500 MB

Ports Needed

TCP/IP port 32000

TCP/IP port 32200

UP/IP Port 19995



Important: Administrative rights may be required to install the Banner 3D Configuration software.

⁶ Microsoft and Windows are registered trademarks of Microsoft Corporation in the United States and/or other countries.

5.6 Dimensions

All measurements are listed in millimeters [inches], unless noted otherwise.

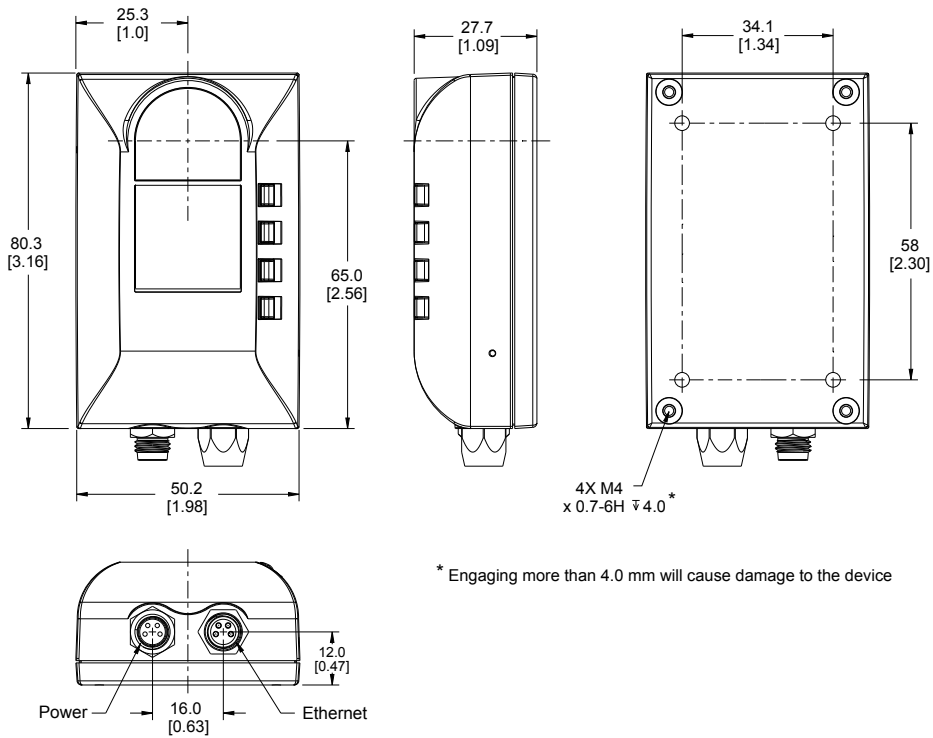

* Engaging more than 4.0 mm will cause damage to the device

5.7 Field of View Charts

Figure 22. FOV Chart

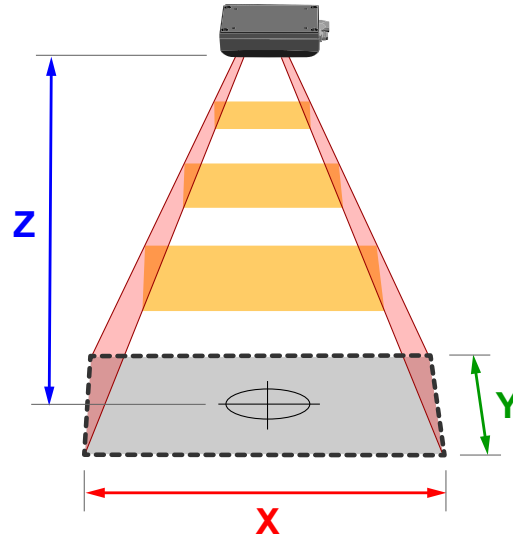

| Z (mm) | X (mm) | Y (mm) |
|--------|--------|--------|
| 250 | 290 | 221 |
| 500 | 602 | 461 |
| 750 | 915 | 700 |
| 1000 | 1228 | 939 |
| 1500 | 1853 | 1417 |
| 2000 | 2478 | 1895 |
| 2500 | 3104 | 2374 |
| 3000 | 3729 | 2852 |

5.8 Factory Defaults

The following table lists some of the factory default settings for both the device and the software.

| Setting | Factory Default |
|--------------------------|---|
| IP Address | 192.168.0.10 |
| Subnet Mask | 255.255.255.0 |
| Gateway | 0.0.0.0 |
| Trigger Mode | Internal at 250 ms or 4 frames per second |
| Illumination Power | 40% |
| Pitch | 0° |
| Roll | 0° |
| Yaw | 0° |
| Discrete Output Polarity | PNP |
| DHCP | Disabled |
| Industrial Protocols | Off |

To restore the sensor to the factory default settings, go to the **Sensor Maintenance** pane and click **Reset To Factory Defaults**.

6 Industrial Ethernet Overview

6.1 EtherNet/IP™

In this context, references to EtherNet/IP™⁹ refer specifically to EtherNet/IP transport class 1. Sometimes referred to as cyclic EtherNet/IP IO data transfer or implicit messaging, this connection is meant to approximate a real-time data transfer to and from the PLC and the target device.

Allen-Bradley's CompactLogix® and ControlLogix®¹⁰ family of PLCs uses this communication protocol. The programming software used by these PLCs is RSLogix5000® or Studio 5000 Logix Designer™¹¹.

The ZMX is controlled via EtherNet/IP using assembly objects.

The Originator of the EtherNet/IP connection is the PLC. The Target of the EtherNet/IP connection is the ZMX. The direction of communication can be described as T > O or O > T (sometimes also shown as T2O or O2T).

6.1.1 Configuring the Sensor to use an Industrial Protocol

Use the following instructions to enable the Modbus TCP protocol or the EtherNet/IP protocol on the ZMX sensor.

1. Go to the **Communications** pane in the Banner 3D Configuration software.

Figure 23. Communications Pane

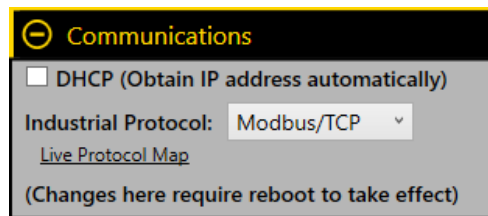

2. From the **Industrial Protocol** menu, select the desired protocol.
A sensor reboot may be required.
3. Click **Live Protocol Map** to open a view of the data.

Figure 24. Industrial Protocol Live View—Modbus TCP Shown

| INBOUND REGISTERS (Changes: 000000000) | | | | | OUTBOUND REGISTERS (Changes: 000000183) | | | | |
|--|----------------------|-------|------------------|---------|---|----------------------|-------|---------------------|---------|
| Registers | Description | Type | Value | Units | Registers | Description | Type | Value | Units |
| 1 | Inputs | COILS | 0000000000000000 | | 1 | ACK + Status Bits | COILS | 0000000000000000 | |
| 3 | Trigger Mode | INT16 | 1 | enum | 3 | Sensor Fault Code | INT16 | 0 | |
| 4 | Trigger Period | INT16 | 00s:250ms | msec | 4 | Boot Count | INT16 | 136 | counts |
| 5 | Illumination Power | INT16 | 40 | percent | 5-6 | Up Time | INT32 | 0000h:06m:10s:120ms | msec |
| 13 | Pitch Angle | INT16 | 0 | .01 deg | 7-8 | Missed Triggers | INT32 | 0 | counts |
| 14 | Roll Angle | INT16 | 0 | .01 deg | 16-17 | Frame Number | INT32 | 1 | |
| 15 | Yaw Angle | INT16 | 0 | .01 deg | 18-19 | Invalid Pixels | INT32 | 0 | counts |
| 19 | Discrete Polarity | INT16 | 0 | enum | 20-21 | Saturated Pixels | INT32 | 0 | counts |
| 21 | Fill Level Setpoint | INT16 | 85 | percent | 22 | Config.Error Code | INT16 | 0 | |
| 23 | Peak Height Setpoint | INT16 | 1,500 | mm | 24 | Bin Fill Level | INT16 | 0 | percent |
| 25 | Output 1 Mode | INT16 | 11 | enum | 25 | Bin Peak Height | INT16 | 0 | mm |
| 26 | Output 2 Mode | INT16 | 20 | enum | 26 | Bin Items Counted | INT16 | 0 | counts |
| 27 | Bin Anchor Point X | INT16 | 50 | mm | 27 | Bin Output1 PFM | INT16 | 0 | Hz |
| 28 | Bin Anchor Point Y | INT16 | 0 | mm | 28 | Bin Output2 PFM | INT16 | 0 | Hz |
| 29 | Bin Anchor Point Z | INT16 | 2,160 | mm | 29 | Trigger Mode | INT16 | 1 | enum |
| 30 | Bin Length X | INT16 | 1,020 | mm | 30 | Trigger Period | INT16 | 00s:250ms | msec |
| 31 | Bin Width Y | INT16 | 690 | mm | 31 | Illumination Power | INT16 | 40 | percent |
| 32 | Bin Height Z | INT16 | 1,500 | mm | 40 | Pitch Angle | INT16 | 0 | .01 deg |
| | | | | | 41 | Roll Angle | INT16 | 0 | .01 deg |
| | | | | | 42 | Yaw Angle | INT16 | 0 | .01 deg |
| | | | | | 46 | Discrete Polarity | INT16 | 0 | enum |
| | | | | | 48 | Fill Level Setpoint | INT16 | 85 | percent |
| | | | | | 50 | Peak Height Setpoint | INT16 | 1,500 | mm |
| | | | | | 52 | Output 1 Mode | INT16 | 11 | |
| | | | | | 53 | Output 2 Mode | INT16 | 20 | |
| | | | | | 54 | Bin Anchor Point X | INT16 | 50 | mm |
| | | | | | 55 | Bin Anchor Point Y | INT16 | 0 | mm |
| | | | | | 56 | Bin Anchor Point Z | INT16 | 2,160 | mm |
| | | | | | 57 | Bin Length X | INT16 | 1,020 | mm |
| | | | | | 58 | Bin Width Y | INT16 | 690 | mm |
| | | | | | 59 | Bin Height Z | INT16 | 1,500 | mm |

⁹ EtherNet/IP™ is a trademark of ODVA, Inc.

¹⁰ CompactLogix® and ControlLogix® are registered trademarks of Rockwell Automation.

¹¹ RSLogix5000® and Studio 5000 Logix Designer™ are registered trademarks of Rockwell Automation.

6.1.2 ZMX Series EDS File Installation in ControlLogix Software

Use the **EDS Hardware Installation Tool** to register the Electronic Data Sheet (EDS) file.

1. On the **Tools** menu, click **EDS Hardware Installation Tool**.
The **Rockwell Automation's EDS Wizard** dialog displays.

Figure 25. Tools—EDS Hardware Installation Tool

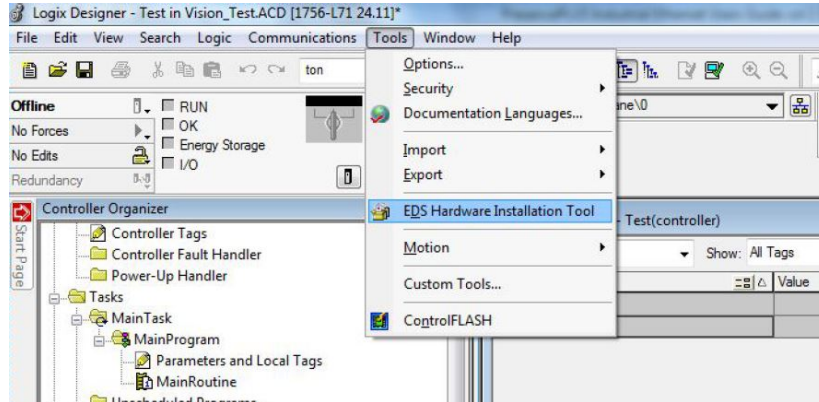

2. Click **Next**.
3. Select the **Register an EDS file(s)** option.

Figure 26. Rockwell Automation's EDS Wizard—Options



4. Browse to locate the EDS file and click **Next**.

Figure 27. Select File to Register

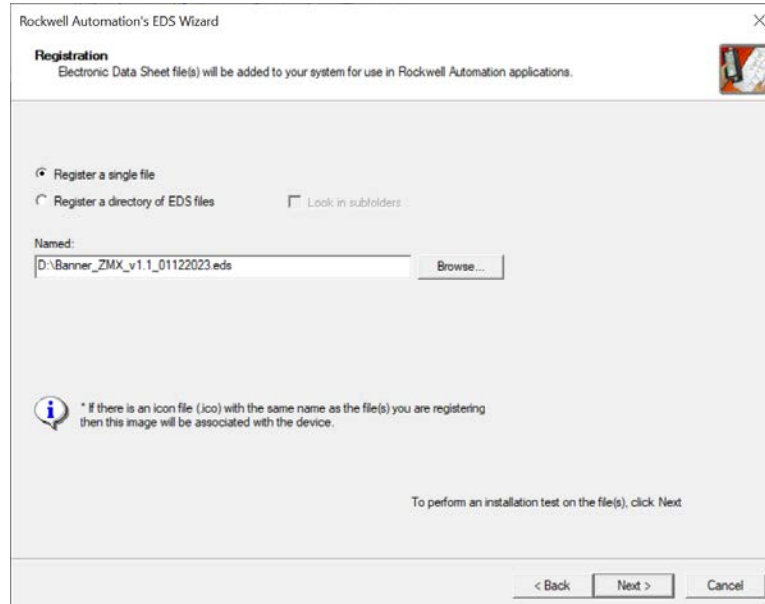

5. Click **Next** to register the tested file.

Figure 28. Register the Tested File

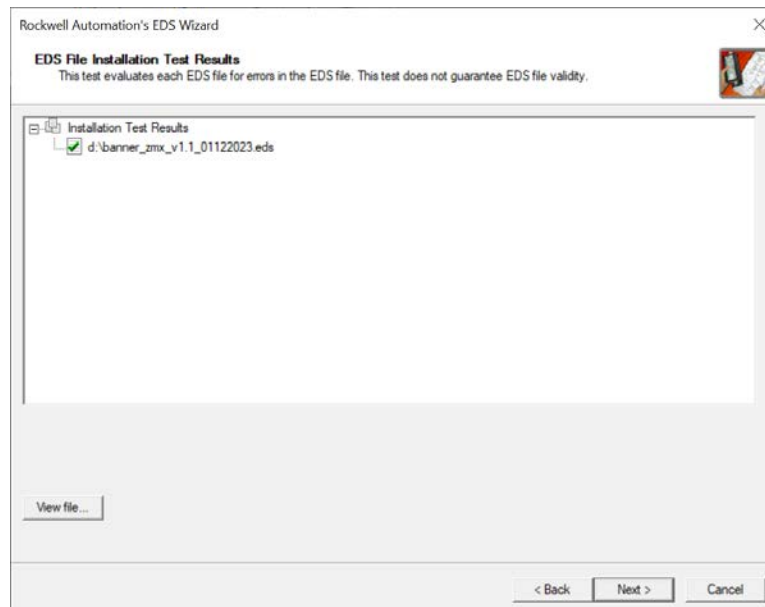

6. Click **Next** when you see the icon associated with the EDS file.

Figure 29. Rockwell Automation's EDS Wizard

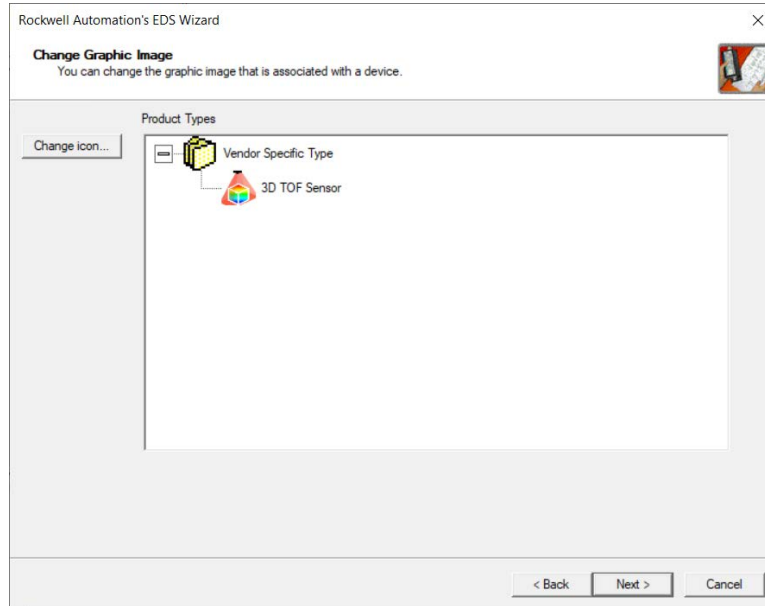

7. Click **Next** to register the EDS file.

Figure 30. Register the EDS File

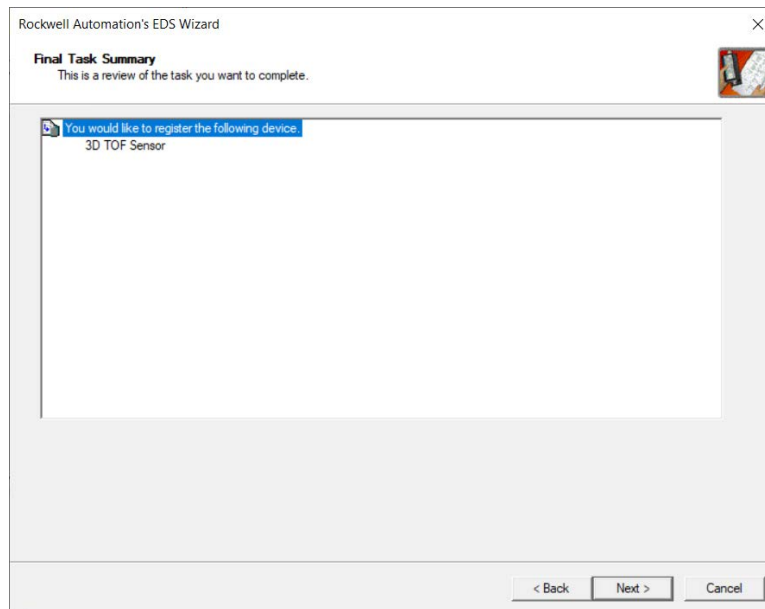

8. Click **Finish** to close the **EDS Wizard** .
9. Right-click on the PLC's Ethernet adapter and select **New Module...**

Figure 31. New Module

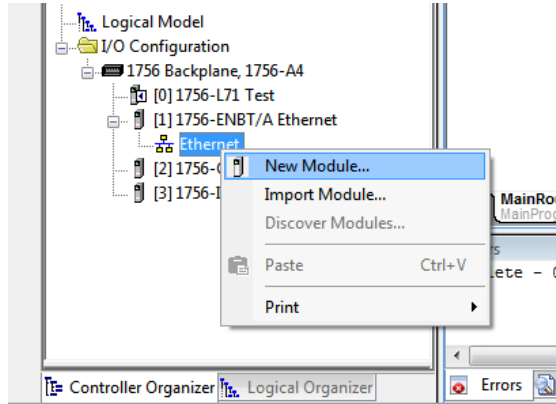

10. Locate the device in the catalog and click **Create**.

Figure 32. Select Module Type

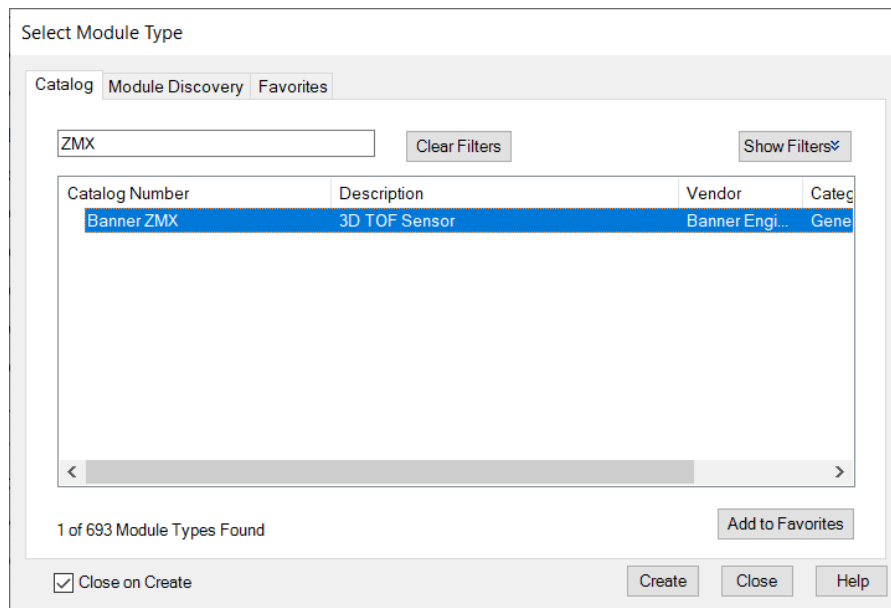

11. Enter a name, description (optional), and IP address for the device.

Figure 33. New Module

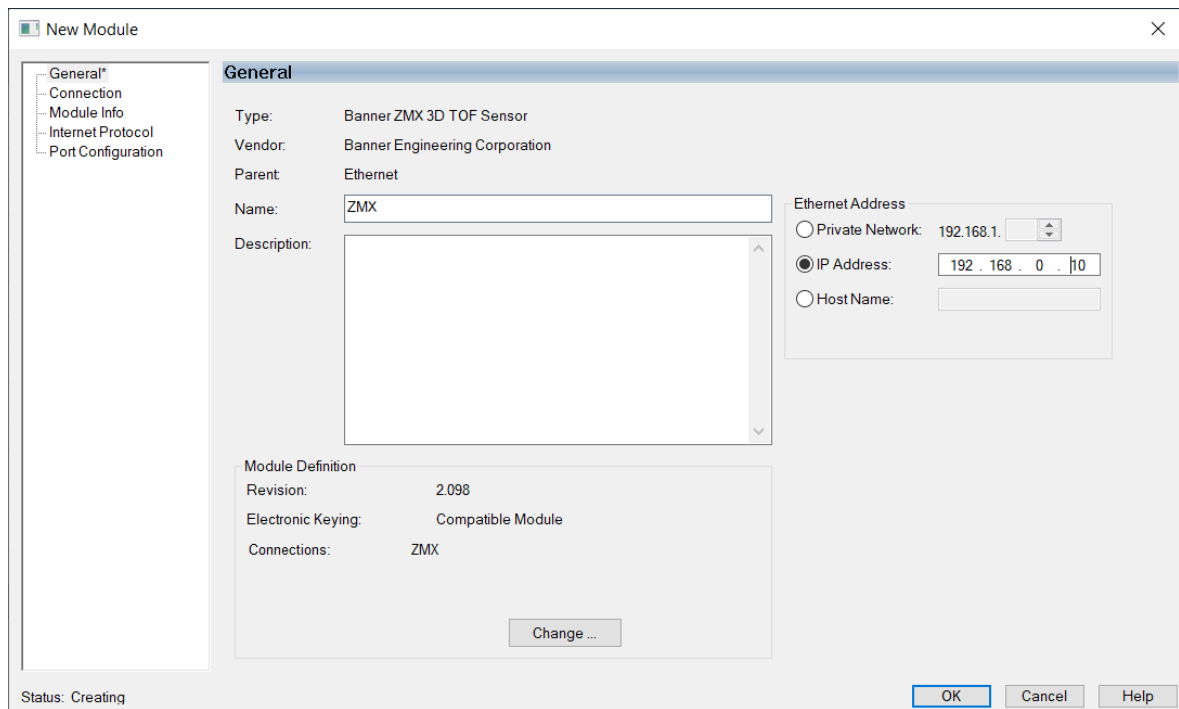

12. Click **Change** in the **Module Definition** field.

Figure 34. Module Definition

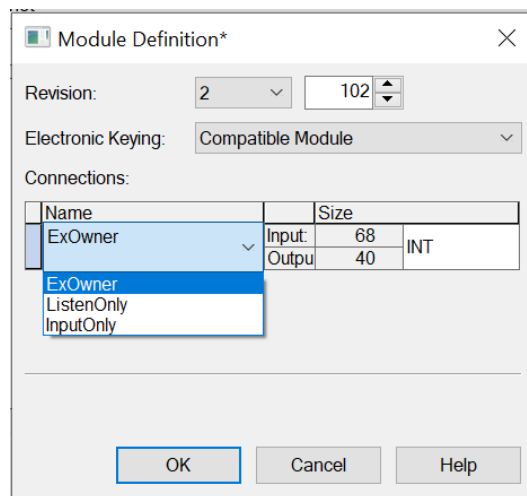

Note: The ZMX supports three types of EtherNet/IP connections: Exclusive Owner (ExOwner), Listen Only, and Input Only. Most users select Exclusive Owner because it provides full control of both the input and output data. An Input Only connection provides the T > O (ZMX output data) to the PLC. A Listen Only connection provides the T > O (ZMX output data) to a device wishing to listen to an existing multicast connection.

13. Select the desired connection in the **Module Definition** window. Each of the items in the **Name** list represents a fixed grouping of input and output assembly instances:

- ExOwner**
 - T > O PLC Input/ZMX Output Assembly 100 (0×64), size 68 16-bit registers
 - O > T PLC Output/ZMX Input Assembly 112 (0×70), size 40 16-bit registers

Listen Only T > O PLC Input/ZMX Output Assembly 100 (0×64)

Input Only T > O PLC Input/ZMX Output Assembly 100 (0×64)

14. Select **INT** as the data type.

Figure 35. Module Definition—Data Type

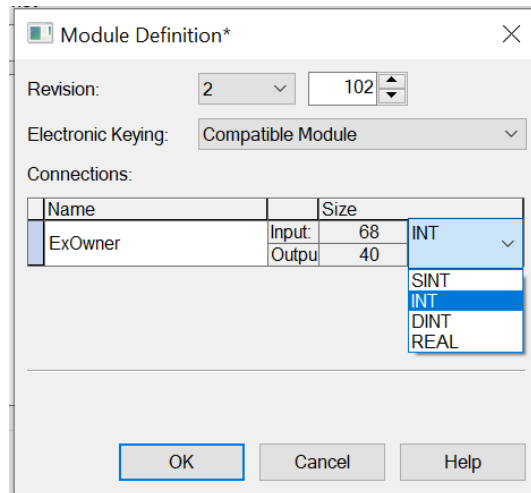

15. Click **OK** twice and download the program to the PLC.

Figure 36. Download to the PLC

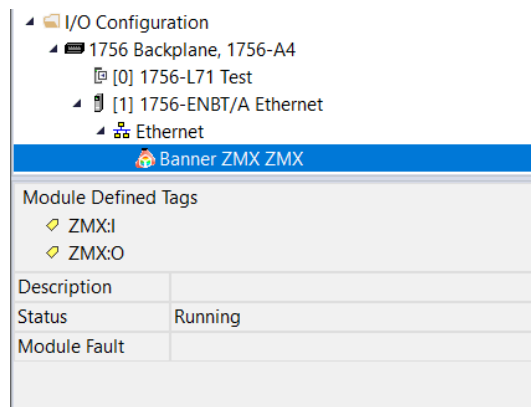

The connection looks like the one in [Figure 36](#) on page 31.

6.1.3 EtherNet/IP Configuration Using Generic Ethernet Module

To create an implicit Class 1 configuration to the ZMX using EtherNet/IP when using a ControlLogix family PLC, configure the ZMX as a “Generic Ethernet Module”. The following is a sample setup of a Banner device using RSLogix5000® or Studio 5000 Logix Designer software:

1. Add a generic Ethernet module to the PLC's Ethernet card.
 - a) Right-click and select **New Module**.

Figure 37. Add Ethernet Module

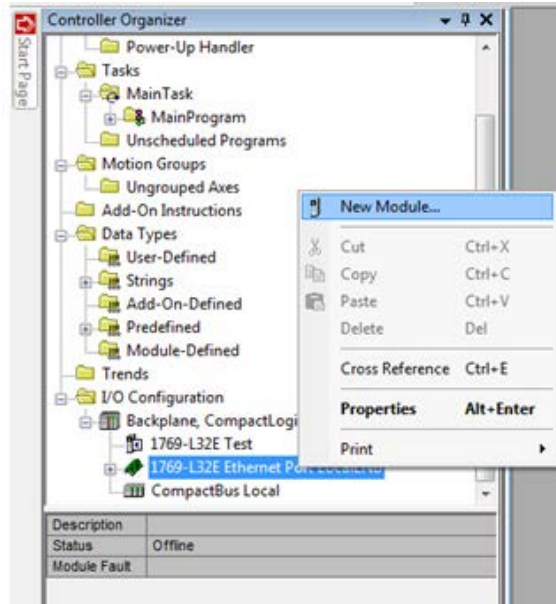

- The **Select Module Type** window opens.
- b) Select **Generic Ethernet Module**.

Figure 38. Select Module Type

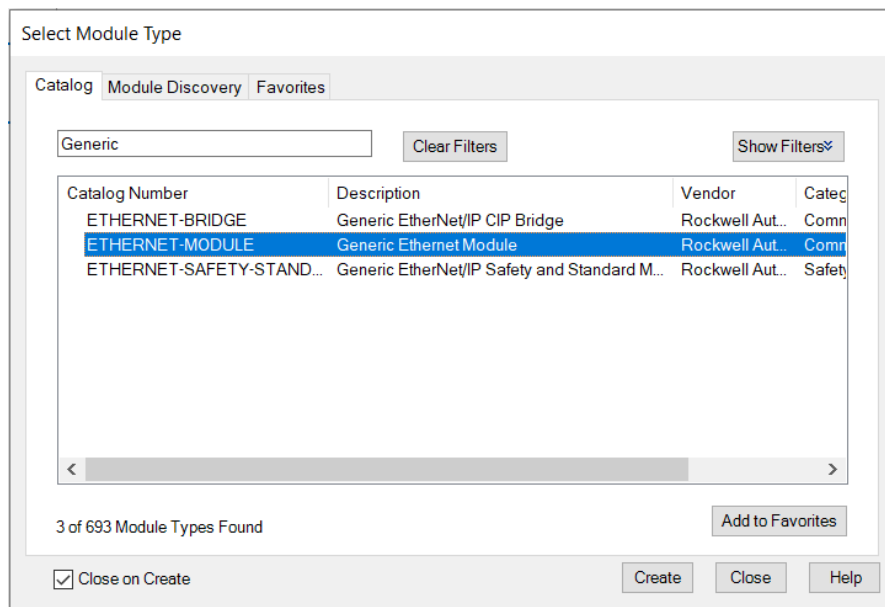

- The **New Module** window opens.
- 2. Configure the Module Properties.
 - a) Change the **Comm Format** to **Data - INT**.

Figure 39. Comm Format

The 'New Module' dialog box is shown with the following details:

- Type: ETHERNET-MODULE Generic Ethernet Module
- Vendor: Rockwell Automation/Allen-Bradley
- Parent: Ethernet
- Name: [Empty text box]
- Description: [Empty text box]
- Comm Format: Data - DINT (dropdown menu is open showing options: Data - DINT, Data - DINT - With Status, Data - INT, Data - INT - With Status, Data - REAL, Data - REAL - With Status, Data - SINT, Data - SINT - With Status, Input Data - DINT, Input Data - DINT - Run/Program)
- Address / Host Name:
 - IP Address: [Empty text box]
 - Host Name: [Empty text box]
- Open Module:
- Connection Parameters:

| | Assembly Instance: | Size: | |
|----------------|--------------------|------------------|----------|
| Input | [Empty text box] | 125 | (32-bit) |
| Output | [Empty text box] | 124 | (32-bit) |
| Configuration: | [Empty text box] | 0 | (8-bit) |
| Status Input: | [Empty text box] | [Empty text box] | |
| Status Output: | [Empty text box] | [Empty text box] | |

- b) Enter a module **Name** and **IP address**.

The default IP address is 192.168.0.10 with a subnet mask of 255.255.255.0.

- c) Under Connection Parameters, enter the **Assembly Instance** parameters and **Size** parameters.

PLC Input Assembly 100 (0x64), size 68 words
 PLC Output Assembly 112 (0x64), size 40 words
 PLC Configuration Assembly 128 (0x64), size 0 words

Figure 40. New Module Window

The 'New Module' dialog box is shown with the following details:

- Type: ETHERNET-MODULE Generic Ethernet Module
- Vendor: Rockwell Automation/Allen-Bradley
- Parent: Ethernet
- Name: ZMX
- Description: [Empty text box]
- Comm Format: Data - INT
- Address / Host Name:
 - IP Address: 192 . 168 . 0 . 10
 - Host Name: [Empty text box]
- Open Module Properties:
- Connection Parameters:

| | Assembly Instance: | Size: | |
|----------------|--------------------|------------------|----------|
| Input | 100 | 68 | (16-bit) |
| Output | 112 | 40 | (16-bit) |
| Configuration: | 128 | 0 | (8-bit) |
| Status Input: | [Empty text box] | [Empty text box] | |
| Status Output: | [Empty text box] | [Empty text box] | |

- d) On the **Connection** tab, set the **Requested Packet Interval (RPI)** and select the **Use Unicast Connect over EtherNet/IP** checkbox.

Figure 41. Connection Tab

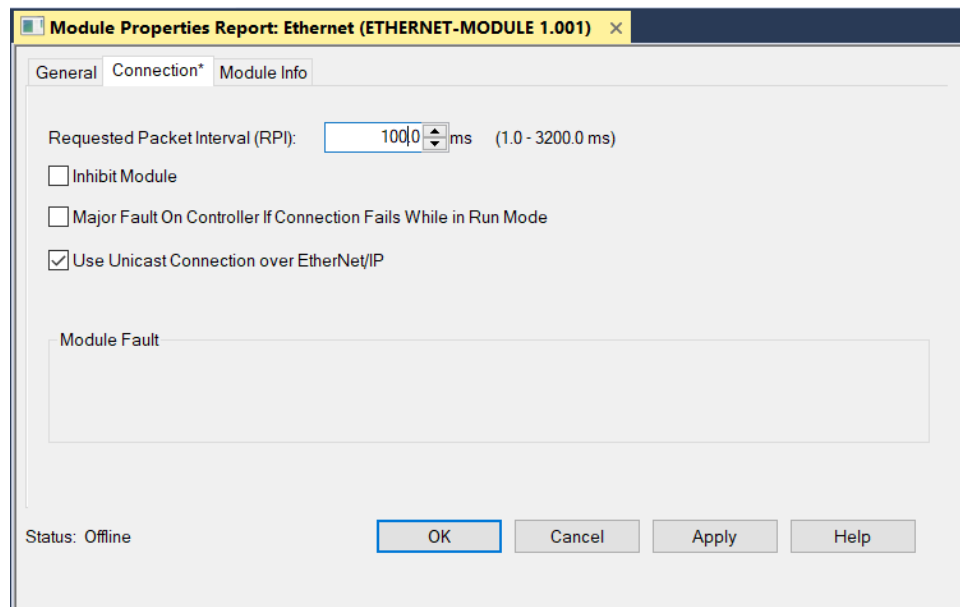

Note: The recommended minimum RPI is 100 msec.

- If the module configuration was successful, the following information displays:

Figure 42. Successful Configuration

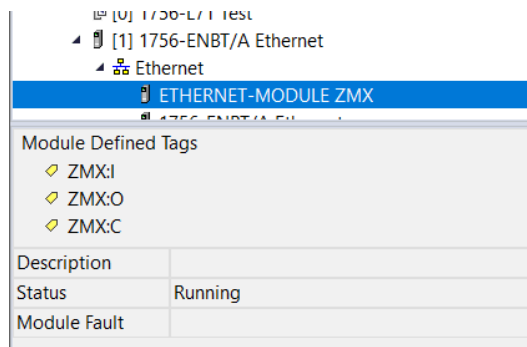

Module Defined Tags

- C = Configuration (not used)
- I = Inputs to PLC (outputs from the device)
- O = Outputs from PLC (inputs to the device)

6.1.4 Assembly Objects

Inputs to the Sensor (Outputs from the PLC)

PLC Assembly Instance 112 (0x70) - 40 Registers (ZMX Inputs/PLC Outputs) O > T

This Assembly Instance includes parameters to control the ZMX sensor.

Table 2: PLC Assembly Instance 112 (0x70)

| WORD # | WORD NAME | DATA TYPE | RELEVANT INPUT BITS | RANGE & INFO |
|--------|---|------------|---------------------|--------------|
| 0 | Input bits (see Flags on page 37) | 16 bits | | |
| 1 | <i>reserved</i> | 16-bit INT | | |

| WORD # | WORD NAME | DATA TYPE | RELEVANT INPUT BITS | RANGE & INFO |
|--------|---|------------|---------------------|--|
| 2 | Trigger Mode ¹⁷ | 16-bit INT | 14, 1 | Trigger Mode: 1 = External 5 = Internal (uses Trigger Period in ms) 6 = Free Run 10 = Software (EIP) |
| 3 | Trigger Period (ms) ¹⁷ | 16-bit INT | 14, 1 | 100 ... 60,000 |
| 4 | Illumination Power (%) ¹⁷ | 16-bit INT | 14, 1 | 1 ... 100 |
| 5–11 | <i>reserved</i> | 16-bit INT | | |
| 12 | Pitch Angle (degrees × 100) ¹⁷ | 16-bit INT | 14, 1 | -4,500 ... 4,500 |
| 13 | Roll Angle (degrees × 100) ¹⁷ | 16-bit INT | 14, 1 | -4,500 ... 4,500 |
| 14 | Yaw Angle (degrees × 100) ¹⁷ | 16-bit INT | 14, 1 | -18,000 ... 18,000 |
| 15–17 | <i>reserved</i> | 16-bit INT | | |
| 18 | Discrete I/O Polarity ¹⁷ | 16-bit INT | 14, 1 | Polarity Mode: 0 = PNP 1 = NPN 2 = Push-Pull |
| 19 | <i>reserved</i> | 16-bit INT | | |
| 20 | Fill Level Limit Setpoint (%) ¹⁸ | 16-bit INT | 0, 1 | 0 ... 200 |
| 21 | <i>reserved</i> | 16-bit INT | | |
| 22 | Peak Height Limit Setpoint (mm) ¹⁸ | 16-bit INT | 0, 1 | 0 ... 2,950 ¹⁹ |
| 23 | <i>reserved</i> | 16-bit INT | | |
| 24 | Discrete Output 1 Control Mode ¹⁸ | 16-bit INT | 0, 1 | Discrete Output 1 & 2 Mode: 0 = Disabled 1 = Fill percent above setpoint 2 = Peak height above setpoint 9 = Fill percent above setpoint OR peak height above setpoint 10 = Pulse Pro 100Hz to 600Hz scaled to fill percent 0 to 100 11 = Pulse Pro 100Hz to 600Hz scaled to peak height above bottom of container 20 = No output, channel used as input |
| 25 | Discrete Output 2 Control Mode ¹⁸ | 16-bit INT | 0, 1 | |
| 26 | ROI Anchor Point X (mm) ¹⁸ | 16-bit INT | 0, 1 | -2,500 ... 2,500 |
| 27 | ROI Anchor Point Y (mm) ¹⁸ | 16-bit INT | 0, 1 | -2,500 ... 2,500 |
| 28 | ROI Anchor Point Z (mm) ¹⁸ | 16-bit INT | 0, 1 | 200 ... 3,000 |
| 29 | ROI Length (X) (mm) ¹⁸ | 16-bit INT | 0, 1 | 50 ... 5,000 |
| 30 | ROI Width (Y) (mm) ¹⁸ | 16-bit INT | 0, 1 | 50 ... 5,000 |
| 31 | ROI Height (Z) (mm) ¹⁸ | 16-bit INT | 0, 1 | 50 ... 5,000 |
| 32–39 | <i>reserved</i> | 16-bit INT | | |

¹⁷ These parameters use the Enable Inputs bit (bit 14 in word 0 of the PLC Output Assembly). See [Using Input Bits](#) on page 38.

¹⁸ These parameters use the Update ROI Parameters bit (bit 0 in word 0 of the PLC Output Assembly). See [Using Input Bits](#) on page 38.

¹⁹ Maximum value is reduced to not extend past the minimum sensing distance.

Outputs from the Sensor (Inputs to the PLC)

PLC Assembly Instance 100 (0x64) - 68 Registers (ZMX Outputs/PLC Inputs) T > O

This Assembly Instance includes the readbacks from the ZMX sensor.

Table 3: PLC Assembly Instance 100 (0x64)

| WORD # | WORD NAME | DATA TYPE | RELEVANT INPUT BITS | RANGE & INFORMATION |
|--------|---|-------------|---------------------|---|
| 0 | Input ACK & Status bits (see Flags on page 37) | 16 bits | | |
| 1 | <i>reserved</i> | 16-bit INT | | |
| 2 | Sensor Fault Code (see Sensor Fault Codes on page 44) | 16-bit INT | | |
| 3 | Boot Count | 16-bit INT | | 1 ... 65,535 |
| 4–5 | Up Time (ms) | 32-bit DINT | | 1 ... 4,294,967,295 |
| 6–7 | Missed Trigger Count | 32-bit DINT | | 1 ... 4,294,967,295 |
| 8–14 | <i>reserved</i> | 16-bit INT | | |
| 15–16 | Frame Number | 32-bit DINT | | 1 ... 4,294,967,295 |
| 17–18 | Invalid Pixel Count | 32-bit DINT | | 0 ... 56,576 |
| 19–20 | Saturated Pixel Count | 32-bit DINT | | 0 ... 56,576 |
| 21 | Configuration Error Code (see Configuration Error Codes on page 45) | 16-bit INT | | |
| 22 | <i>reserved</i> | 16-bit INT | | |
| 23 | Fill Level % | 16-bit INT | 3 | 0 ... 200 |
| 24 | Peak Height (mm) | 16-bit INT | 3 | 0 ... 3,500 |
| 25 | Estimated Item Count | 16-bit INT | 3 | |
| 26 | Output 1 PFM Frequency (Hz) | 16-bit INT | | 0 100 ... 600 |
| 27 | Output 2 PFM Frequency (Hz) | 16-bit INT | | 0 100 ... 600 |
| 28 | Trigger Mode ²⁰ | 16-bit INT | | Trigger Mode: 1 = External 5 = Internal (uses Trigger Period in ms) 6 = Free Run 10 = Software (EIP) |
| 29 | Trigger Period (ms) ²⁰ | 16-bit INT | | 100 ... 60,000 |
| 30 | Illumination Power (%) ²⁰ | 16-bit INT | | 1 ... 100 |
| 31–38 | <i>reserved</i> | 16-bit INT | | |
| 39 | Pitch Angle (degrees × 100) ²⁰ | 16-bit INT | | -4,500 ... 4,500 |
| 40 | Roll Angle (degrees × 100) ²⁰ | 16-bit INT | | -4,500 ... 4,500 |
| 41 | Yaw Angle (degrees × 100) ²⁰ | 16-bit INT | | -18,000 ... 18,000 |
| 42–44 | <i>reserved</i> | 16-bit INT | | |
| 45 | Discrete I/O Polarity ²⁰ | 16-bit INT | | Polarity Mode: 0 = PNP 1 = NPN 2 = Push-Pull |

²⁰ Readbacks of the current application settings.

| WORD # | WORD NAME | DATA TYPE | RELEVANT INPUT BITS | RANGE & INFORMATION |
|--------|---|------------|---------------------|--|
| 46 | <i>reserved</i> | 16-bit INT | | |
| 47 | Fill Level Limit Setpoint (%) ²⁰ | 16-bit INT | | 0 ... 200 |
| 48 | <i>reserved</i> | 16-bit INT | | |
| 49 | Peak Height Limit Setpoint (mm) ²⁰ | 16-bit INT | | 0 ... 2,950 ²¹ |
| 50 | <i>reserved</i> | 16-bit INT | | |
| 51 | Discrete Output 1 Control Mode ²⁰ | 16-bit INT | | Discrete Output 1 & 2 Mode: 0 = Disabled 1 = Fill percent above setpoint 2 = Peak height above setpoint 9 = Fill percent above setpoint OR peak height above setpoint 10 = Pulse Pro 100Hz to 600Hz scaled to fill percent 0 to 100 11 = Pulse Pro 100Hz to 600Hz scaled to peak height above bottom of container 20 = No output, channel used as input |
| 52 | Discrete Output 2 Control Mode ²⁰ | 16-bit INT | | |
| 53 | ROI Anchor Point X (mm) ²⁰ | 16-bit INT | | -2,500 ... 2,500 |
| 54 | ROI Anchor Point Y (mm) ²⁰ | 16-bit INT | | -2,500 ... 2,500 |
| 55 | ROI Anchor Point Z (mm) ²⁰ | 16-bit INT | | 200 ... 3,000 |
| 56 | ROI Length (X) (mm) ²⁰ | 16-bit INT | | 50 ... 5,000 |
| 57 | ROI Length (Y) (mm) ²⁰ | 16-bit INT | | 50 ... 5,000 |
| 58 | ROI Length (Z) (mm) ²⁰ | 16-bit INT | | 50 ... 3,000 |
| 59–67 | <i>reserved</i> | 16-bit INT | | |

Configuration Assembly Object

The ZMX sensor does not use a Configuration Assembly Object.

Because some EtherNet/IP clients require one, use Instance 128 (0×80) with a size of zero registers (16-bit).

Flags

Word 0 in both Assembly Instances is a collection of individual bit values, as shown in the following table.

Table 4: Input Bits and Input ACK & Status Bits

| Input bits (PLC Outputs, word 0) | | Input ACK & Status bits (PLC Inputs, word 0) | |
|----------------------------------|---------------------------|--|-------------------------------|
| Bit # | Name | Bit # | Name |
| 0 | Update ROI Parameters | 0 | Update ROI Parameters ACK |
| 1 | Save Parameters Permanent | 1 | Save Parameters Permanent ACK |
| 2 | Reset Application Results | 2 | Reset Application Results ACK |
| 3 | Trigger | 3 | Trigger ACK |
| 4 | <i>reserved</i> | 4 | <i>reserved</i> |
| 5 | <i>reserved</i> | 5 | <i>reserved</i> |
| 6 | <i>reserved</i> | 6 | Fill Level Limit |
| 7 | <i>reserved</i> | 7 | <i>reserved</i> |
| 8 | <i>reserved</i> | 8 | Peak Height Limit |

²¹ Maximum value is reduced to not extend past the minimum sensing distance.

| Input bits (PLC Outputs, word 0) | | Input ACK & Status bits (PLC Inputs, word 0) | |
|----------------------------------|-------------------|--|---------------------------|
| Bit # | Name | Bit # | Name |
| 9 | <i>reserved</i> | 9 | <i>reserved</i> |
| 10 | <i>reserved</i> | 10 | Discrete Output State (1) |
| 11 | <i>reserved</i> | 11 | Discrete Output State (2) |
| 12 | <i>reserved</i> | 12 | <i>reserved</i> |
| 13 | <i>reserved</i> | 13 | <i>reserved</i> |
| 14 | Enable Inputs bit | 14 | <i>reserved</i> |
| 15 | <i>reserved</i> | 15 | Configuration Error |

6.1.5 Controlling the ZMX Sensor

Using Input Bits

Writeable Input Bits are inputs to the sensor (outputs from the PLC or HMI). They are used for basic control of the sensor. Toggle them from 0 to 1, one at a time, to request the associated action. Most bits have a corresponding ACK Output bit that changes to 1 in response, to indicate that the action has been completed. The ACK bits reset to 0 when the command bit is reset to 0.

Update ROI Parameters—This action tells the sensor to take all of the new bin fill parameters, as a group, and apply them to the sensor.

1. Enter the desired PLC Output values for all bin fill parameters:
 - Fill Level Setpoint (word 20)
 - Peak Height Limit Setpoint (word 22)
 - Discrete Output 1 Control Mode (word 24)
 - Discrete Output 2 Control Mode (word 25)
 - ROI Anchor Point X (word 26)
 - ROI Anchor Point Y (word 27)
 - ROI Anchor Point Z (word 28)
 - ROI Length (X) (word 29)
 - ROI Width (Y) (word 30)
 - ROI Height (Z) (word 31)
2. Toggle the Update ROI Parameters bit (word 0, bit 0, PLC Outputs) from 0 to 1.
3. Look for the corresponding Update ROI Parameters ACK bit (word 0, bit 0, PLC Inputs) to go from 0 to 1.
4. Confirm that the Configuration Error bit (word 0, bit 15, PLC Inputs) is still 0.

If it is a 1, read the Configuration Error Code (word 21, PLC Inputs) and correct the error. See [Configuration Error Codes](#) on page 45.

Save Parameters Permanent— This action tells the sensor to take all editable parameters modifiable over EtherNet/IP and save them in the sensor's permanent memory. This includes the size and position of the Region of Interest, as well as settings such as Trigger Mode and Output Control Mode.

Reset Application Results—This action resets all measurement output values to 0 in the EtherNet/IP registers.

Trigger—This action triggers an immediate image acquisition and measurement.

Enable Inputs—This bit controls whether changes to basic sensor parameters like Trigger Mode, Trigger Period, Illumination Power, Pitch, Roll, and Yaw Angle, and Discrete I/O Polarity should take effect in the sensor. To adjust these parameters on the fly:

1. Toggle the Enable Inputs bit from 0 to 1 (word 0, bit 14, PLC Outputs).
2. Adjust any of the above parameters as needed.

The new values will take effect only if the Enable Inputs bit is a 1 and the new value written represents a change from the previous value.

6.2 Modbus[®] TCP

The Modbus[®] 23 TCP protocol provides device information using register and coil banks defined by the slave device. Modbus TCP can also be used to modify parameters of the sensor.



Important: Parameter changes over Modbus TCP are only stored in temporary memory and are not retained through a reboot unless the Save Parameters Permanent Input Bit is used.

This section defines the register and coil banks. By specification, Modbus TCP uses TCP port 502.

The Modbus Client must use a UNIT ID of 1 or higher to connect to the ZMX sensor. The Modbus TCP remote unit identifier is used with Modbus TCP devices that are composites of several Modbus devices. For example, on Modbus TCP to Modbus RTU gateways. In this case, the unit identifier tells the Slave Address of the device behind the gateway. Most Modbus TCP Clients use a Unit ID of 1 or higher.

The Input Bits can be set as Coils using Modbus function code 05 (Force Single Coil). The state of the Input ACK Bits and Status Bits can be read as Inputs (10000) using Modbus function code 02 (Read Input Status).

Modbus Function Codes Supported

- 01: Read Coil Status
- 02: Read Input Status
- 03: Read Holding Registers
- 04: Read Input Registers
- 05: Force Single Coil
- 06: Preset Single Register
- 07: Read Exception Status
- 16: Preset Multiple Registers

Table 5: Modbus TCP Input and Output Bits

| Input Bits | | Output Bits | |
|-------------------------------------|---------------------------|-------------------------------------|-------------------------------|
| Function Code 05: Force Single Coil | | Function Code 02: Read Input Status | |
| Coil | NAME | Input | NAME |
| 00001 | Update ROI Parameters | 10001 | Update ROI Parameters ACK |
| 00002 | Save Parameters Permanent | 10002 | Save Parameters Permanent ACK |
| 00003 | Reset Application Results | 10003 | Reset Application Results ACK |
| 00004 | Trigger | 10004 | Trigger ACK |
| 00005 | <i>reserved</i> | 10005 | <i>reserved</i> |
| 00006 | <i>reserved</i> | 10006 | <i>reserved</i> |
| 00007 | <i>reserved</i> | 10007 | Fill Level Limit |
| 00008 | <i>reserved</i> | 10008 | <i>reserved</i> |
| 00009 | <i>reserved</i> | 10009 | Peak Height Limit |
| 00010 | <i>reserved</i> | 10010 | <i>reserved</i> |
| 00011 | <i>reserved</i> | 10011 | Discrete Output State (1) |
| 00012 | <i>reserved</i> | 10012 | Discrete Output State (2) |
| 00013 | <i>reserved</i> | 10013 | <i>reserved</i> |
| 00014 | <i>reserved</i> | 10014 | <i>reserved</i> |
| 00015 | <i>reserved</i> | 10015 | <i>reserved</i> |
| 00016 | <i>reserved</i> | 10016 | Configuration Error |

²³ Modbus[®] is a registered trademark of Schneider Electric USA, Inc.

6.2.1 Configuring the Sensor to use an Industrial Protocol

Use the following instructions to enable the Modbus TCP protocol or the EtherNet/IP protocol on the ZMX sensor.

1. Go to the **Communications** pane in the Banner 3D Configuration software.

Figure 43. Communications Pane

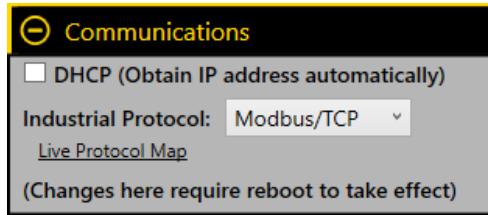

2. From the **Industrial Protocol** menu, select the desired protocol.
A sensor reboot may be required.
3. Click **Live Protocol Map** to open a view of the data.

Figure 44. Industrial Protocol Live View—Modbus TCP Shown

| INBOUND REGISTERS (Changes: 000000000) | | | | | | OUTBOUND REGISTERS (Changes: 000000183) | | | | | |
|--|----------------------|-------|---|---------|--|---|----------------------|-------|---|---------|--|
| Registers | Description | Type | Value | Units | | Registers | Description | Type | Value | Units | |
| 1 | Inputs | COILS | 16 14 12 10 8 6 4 2 0000000000000000 | | | 1 | ACK + Status Bits | COILS | 16 14 12 10 8 6 4 2 0000000000000000 | | |
| 3 | Trigger Mode | INT16 | 1 | enum | | 3 | Sensor Fault Code | INT16 | 0 | | |
| 4 | Trigger Period | INT16 | 00s:250ms | msec | | 4 | Boot Count | INT16 | 136 | counts | |
| 5 | Illumination Power | INT16 | 40 | percent | | 5-6 | Up Time | INT32 | 0000h:06m:10s:120ms | msec | |
| 13 | Pitch Angle | INT16 | 0 | .01 deg | | 7-8 | Missed Triggers | INT32 | 0 | counts | |
| 14 | Roll Angle | INT16 | 0 | .01 deg | | 16-17 | Frame Number | INT32 | 1 | | |
| 15 | Yaw Angle | INT16 | 0 | .01 deg | | 18-19 | Invalid Pixels | INT32 | 0 | counts | |
| 19 | Discrete Polarity | INT16 | 0 | enum | | 20-21 | Saturated Pixels | INT32 | 0 | counts | |
| 21 | Fill Level Setpoint | INT16 | 85 | percent | | 22 | Config_Error Code | INT16 | 0 | | |
| 23 | Peak Height Setpoint | INT16 | 1,500 | mm | | 24 | Bin Fill Level | INT16 | 0 | percent | |
| 25 | Output 1 Mode | INT16 | 11 | enum | | 25 | Bin Peak Height | INT16 | 0 | mm | |
| 26 | Output 2 Mode | INT16 | 20 | enum | | 26 | Bin Items Counted | INT16 | 0 | counts | |
| 27 | Bin Anchor Point X | INT16 | 50 | mm | | 27 | Bin Output1 PFM | INT16 | 0 | Hz | |
| 28 | Bin Anchor Point Y | INT16 | 0 | mm | | 28 | Bin Output2 PFM | INT16 | 0 | Hz | |
| 29 | Bin Anchor Point Z | INT16 | 2,160 | mm | | 29 | Trigger Mode | INT16 | 1 | enum | |
| 30 | Bin Length X | INT16 | 1,020 | mm | | 30 | Trigger Period | INT16 | 00s:250ms | msec | |
| 31 | Bin Width Y | INT16 | 690 | mm | | 31 | Illumination Power | INT16 | 40 | percent | |
| 32 | Bin Height Z | INT16 | 1,500 | mm | | 40 | Pitch Angle | INT16 | 0 | .01 deg | |
| | | | | | | 41 | Roll Angle | INT16 | 0 | .01 deg | |
| | | | | | | 42 | Yaw Angle | INT16 | 0 | .01 deg | |
| | | | | | | 46 | Discrete Polarity | INT16 | 0 | enum | |
| | | | | | | 48 | Fill Level Setpoint | INT16 | 85 | percent | |
| | | | | | | 50 | Peak Height Setpoint | INT16 | 1,500 | mm | |
| | | | | | | 52 | Output 1 Mode | INT16 | 11 | | |
| | | | | | | 53 | Output 2 Mode | INT16 | 20 | | |
| | | | | | | 54 | Bin Anchor Point X | INT16 | 50 | mm | |
| | | | | | | 55 | Bin Anchor Point Y | INT16 | 0 | mm | |
| | | | | | | 56 | Bin Anchor Point Z | INT16 | 2,160 | mm | |
| | | | | | | 57 | Bin Length X | INT16 | 1,020 | mm | |
| | | | | | | 58 | Bin Width Y | INT16 | 690 | mm | |
| | | | | | | 59 | Bin Height Z | INT16 | 1,500 | mm | |

6.2.2 Using Input Bits

Writeable Coil Bits are inputs to the sensor (outputs from the PLC or HMI). They are used for basic control of the sensor. Toggle them from 0 to 1, one at a time, to request the associated action. Each bit has a corresponding ACK Output bit that changes to 1 in response, to indicate that the action has been completed. The ACK bits reset to 0 when the command bit is reset to 0.

The Input bits can be found in Holding Register 1 or as Coils 00001–00016.

The ACK bits can be found in Input Register 1, Holding Register 1001, or as Inputs 10001–10016.

Update ROI Parameters—This action tells the sensor to take all of the new bin fill parameters, as a group, and apply them to the sensor.

1. Enter the desired PLC Output values for all bin fill parameters:
 - Fill Level Setpoint (Holding Register 21)
 - Peak Height Limit Setpoint (Holding Register 23)
 - Discrete Output 1 Control Mode (Holding Register 25)
 - Discrete Output 2 Control Mode (Holding Register 26)
 - ROI Anchor Point X (Holding Register 27)
 - ROI Anchor Point Y (Holding Register 28)
 - ROI Anchor Point Z (Holding Register 29)

- ROI Length (X) (Holding Register 30)
 - ROI Width (Y) (Holding Register 31)
 - ROI Height (Z) (Holding Register 32)
2. Toggle the Update ROI Parameters bit (Holding Register 1, bit 0 **or** Coil 00001) from 0 to 1.
 3. Look for the corresponding Update ROI Parameters ACK bit (Input Register 0, bit 0 **or** Holding Register 1001, bit 0 **or** Input 10001) to go from 0 to 1.
 4. Confirm that the Configuration Error bit (Input Register 1, bit 15 **or** Holding Register 1001, bit 15 **or** Input 10016) is still 0.

If it is a 1, read the Configuration Error Code (Holding Register 1022 **or** Input Register 22) and correct the error. See [Configuration Error Codes](#) on page 45.

Save Parameters Permanent—This action tells the sensor to take all editable parameters modifiable over Modbus TCP and save them in the sensor's permanent memory. This includes the size and position of the Region of Interest, as well as settings such as Trigger Mode and Output Control Mode.

Reset Application Results—This action resets all measurement output values to 0 in the Modbus TCP registers.

Trigger—This action triggers an immediate image acquisition and measurement.

6.2.3 ZMX Sensor Output Values

The ZMX sensor sends output data to the PLC or HMI via a bank of Input Registers (30000).

Some devices, such as the Modicon family of PLCs, cannot access data using the 30000 range of register addresses. For these devices, the ZMX sensor output data is also made available as Holding Registers (40000). To access this data, use either function code 04 (Read Input Registers) or function code 03 (Read Holding Registers).

| Input REG # | Holding REG # | WORD NAME | DATA TYPE | RANGE |
|-------------|---------------|---|----------------|---------------------|
| 1 | 1001 | Input ACK & Status bits (Inputs 10001–10016) | 16 bits | |
| 2 | 1002 | <i>reserved</i> | 16-bit UINT | |
| 3 | 1003 | Sensor Fault Code (see Sensor Fault Codes on page 44) | 16 bit UINT | |
| 4 | 1004 | Boot Count | 16-bit UINT | 1 ... 65535 |
| 5–6 | 1005–1006 | Up Time (ms) | 32-bit UINT | 1 ... 4,294,967,295 |
| 7–8 | 1007–1008 | Missed Trigger Count | 32-bit UINT | 0 ... 4,294,967,295 |
| 9–15 | 1009–1015 | <i>reserved</i> | 7 16-bit UINTs | |
| 16–17 | 1016–1017 | Frame Number | 32-bit UINT | 1 ... 4,294,967,295 |
| 18–19 | 1018–1019 | Invalid Pixel Count (pixels with too little light received to be able to measure) | 32-bit UINT | 0 ... 56,576 |
| 20–21 | 1020–1021 | Saturated Pixel Count (pixels with too much light received to be able to measure) | 32-bit UINT | 0 ... 56,576 |
| 22 | 1022 | Configuration Error Code (see Configuration Error Codes on page 45) | 16-bit UINT | |
| 23 | 1023 | <i>reserved</i> | 16-bit UINT | |
| 24 | 1024 | Fill Level % | 16-bit UINT | 0 ... 200 |
| 25 | 1025 | Peak Height (mm) | 16-bit UINT | 0 ... 3,500 |
| 26 | 1026 | Estimated Item Count | 16-bit UINT | 0 ... 4,294,967,295 |
| 27 | 1027 | Output 1 PFM Frequency (Hz) | 16-bit UINT | 0 100 ... 600 |
| 28 | 1028 | Output 2 PFM Frequency (Hz) | 16-bit UINT | 0 100 ... 600 |

| Input REG # | Holding REG # | WORD NAME | DATA TYPE | RANGE |
|-------------|---------------|---|----------------|--|
| 29 | 1029 | Trigger Mode ²⁷ | 16-bit UINT | Trigger Mode: 1 = External 5 = Internal (uses trigger period) 6 = Free run 10 = Software (Modbus TCP) |
| 30 | 1030 | Trigger Period (ms) ²⁷ | 16-bit UINT | 200 ... 60000 |
| 31 | 1031 | Illumination Power (%) ²⁷ | 16-bit UINT | 1 ... 100 |
| 32–39 | 1032–1039 | <i>reserved</i> | 8 16-bit UINTs | |
| 40 | 1040 | Pitch angle (degrees × 100) ²⁷ | 16-bit INT | -4500 ... 4500 |
| 41 | 1041 | Roll angle (degrees × 100) ²⁷ | 16-bit INT | -4500 ... 4500 |
| 42 | 1042 | Yaw angle (degrees × 100) ²⁷ | 16-bit INT | -18000 ... 18000 |
| 43–45 | 1043–1045 | <i>reserved</i> | 3 16-bit UINTs | |
| 46 | 1046 | Discrete I/O Polarity ²⁷ | 16-bit UINT | Polarity Mode: 0 = PNP 1 = NPN 2 = Push-Pull |
| 47 | 1047 | <i>reserved</i> | 16-bit UINT | |
| 48 | 1048 | Fill Level Limit Setpoint (%) ²⁷ | 16-bit UINT | 0 ... 200 |
| 49 | 1049 | <i>reserved</i> | 16-bit UINT | |
| 50 | 1050 | Peak Height Limit Setpoint (mm) ²⁷ | 16-bit UINT | 0 ... 2,950** |
| 51 | 1051 | <i>reserved</i> | 16-bit UINT | |
| 52 | 1052 | Discrete Output 1 Control Mode ²⁷ | 16-bit UINT | Discrete Output 1 & 2 Mode: 0 = Disabled 1 = Fill percent above setpoint 2 = Peak height above setpoint 9 = Fill percent above setpoint OR peak height above setpoint 10 = Pulse Pro 100 Hz to 600 Hz scaled from fill percent between 0% to 100% 11 = Pulse Pro 100 Hz to 600 Hz scaled to peak height above bottom of container 20 = No output, channel used as input |
| 53 | 1053 | Discrete Output 2 Control Mode ²⁷ | 16-bit UINT | |
| 54 | 1054 | ROI Anchor Point X (mm) ²⁷ | 16-bit INT | -2,500 ... 2,500 |
| 55 | 1055 | ROI Anchor Point Y (mm) ²⁷ | 16-bit INT | -2,500 ... 2,500 |
| 56 | 1056 | ROI Anchor Point Z (mm) ²⁷ | 16-bit INT | 200 ... 3,000 |
| 57 | 1057 | ROI Length (X) (mm) ²⁷ | 16-bit UINT | 50 ... 5,000 |
| 58 | 1058 | ROI Width (Y) (mm) ²⁷ | 16-bit UINT | 50 ... 5,000 |

²⁷ Readbacks of the current application settings.

| Input REG # | Holding REG # | WORD NAME | DATA TYPE | RANGE |
|-------------|---------------|-----------------------------------|----------------|--------------|
| 59 | 1059 | ROI Height (Z) (mm) ²⁷ | 16-bit UINT | 50 ... 3,000 |
| 60–67 | 1060–1067 | <i>reserved</i> | 8 16-bit UINTs | |

6.2.4 ZMX Sensor Input Values

Holding Registers (40000) are used by the PLC or HMI to write values to the ZMX sensor. To write, use function codes 06 (Preset Single Register) or 16 (Preset Multiple Registers).

| Holding REG # | WORD NAME | DATA TYPE | RANGE & INFO |
|---------------|---------------------------------|----------------|--|
| 1 | Input bits (Coils 00001–00016) | 16 bits | |
| 2 | <i>reserved</i> | 16-bit UINT | |
| 3 | Trigger Mode | 16-bit UINT | Trigger Mode: 1 = External 5 = Internal (uses trigger period) 6 = Free run 10 = Software (Modbus TCP) |
| 4 | Trigger Period (ms) | 16-bit UINT | 100 ... 60,000 |
| 5 | Illumination Power (%) | 16-bit UINT | 0...100 |
| 6–12 | <i>reserved</i> | 7 16-bit UINTs | |
| 13 | Pitch angle (degrees × 100) | 16-bit INT | -4500 ... 4500 |
| 14 | Roll angle (degrees × 100) | 16-bit INT | -4500 ... 4500 |
| 15 | Yaw angle (degrees × 100) | 16-bit INT | -18000 ... 18000 |
| 16–18 | <i>reserved</i> | 3 16-bit UINTs | |
| 19 | Discrete I/O Polarity | 16-bit UINT | Polarity Mode: 0 = PNP 1 = NPN 2 = Push-Pull |
| 20 | <i>reserved</i> | 16-bit UINT | |
| 21 | Fill Level Limit Setpoint (%) | 16-bit UINT | 0 ... 200 |
| 22 | <i>reserved</i> | 16-bit UINT | |
| 23 | Peak Height Limit Setpoint (mm) | 16-bit UINT | 0 ... 2,950 ²⁹ |
| 24 | <i>reserved</i> | 16-bit UINT | |
| 25 | Discrete Output 1 Control Mode | 16-bit UINT | Discrete Output 1 & 2 Mode: 0 = Disabled 1 = Fill percent above setpoint 2 = Peak height above setpoint 9 = Fill percent above setpoint OR peak height above setpoint 10 = Pulse Pro 100 Hz to 600 Hz scaled from fill percent between 0% to 100% 11 = Pulse Pro 100 Hz to 600 Hz scaled to peak height above bottom of container 20 = No output, channel used as input |
| 26 | Discrete Output 2 Control Mode | 16-bit UINT | |
| 27 | ROI Anchor Point X (mm) | 16-bit INT | -2,500 ... 2,500 |
| 28 | ROI Anchor Point Y (mm) | 16-bit INT | -2,500 ... 2,500 |

²⁹ Maximum value is reduced to not extend past the minimum sensing distance.

| Holding REG # | WORD NAME | DATA TYPE | RANGE & INFO |
|---------------|-------------------------|----------------|---------------|
| 29 | ROI Anchor Point Z (mm) | 16-bit INT | 200 ... 3,000 |
| 30 | ROI Length (X) (mm) | 16-bit UINT | 50 ... 5,000 |
| 31 | ROI Width (Y) (mm) | 16-bit UINT | 50 ... 5,000 |
| 32 | ROI Height (Z) (mm) | 16-bit UINT | 50 ... 3,000 |
| 33–40 | <i>reserved</i> | 8 16-bit UINTs | |

6.3 Troubleshooting

6.3.1 Sensor Fault Codes

The following is a list of the possible error codes from Word 2 in the PLC Input (ZMX Output) Assembly Instance.

| Sensor Fault Code | Description | Recommended Solution |
|-------------------|--------------------------------|--|
| 0 | Online, No Fault | |
| 1 | EEPROM Timeout | <ul style="list-style-type: none"> Reboot the sensor If the fault persists, call Banner Customer Support |
| 2 | EEPROM Failure | <ul style="list-style-type: none"> Reboot the sensor If the fault persists, call Banner Customer Support |
| 4 | Acquisition Error | <ul style="list-style-type: none"> Reboot the sensor If the fault persists, call Banner Customer Support |
| 5 | Internal Temperature Error | <ul style="list-style-type: none"> Turn off the power and allow the sensor to cool Use a lower frame rate Use a better heat sink or better airflow |
| 6 | Illumination Temperature Error | <ul style="list-style-type: none"> Turn off the power and allow the sensor to cool Use a lower frame rate Use a better heat sink or better airflow |
| 7 | Main Sensor Temperature Error | <ul style="list-style-type: none"> Turn off the power and allow the sensor to cool Use a lower frame rate Use a better heat sink or better airflow |
| 8 | Acquisition Error 2 | <ul style="list-style-type: none"> Reboot the sensor If the fault persists, call Banner Customer Support |
| 11 | Laser Operation Error | <ul style="list-style-type: none"> Reboot the sensor If the fault persists, call Banner Customer Support |
| 20 | Internal Test Error | <ul style="list-style-type: none"> Reboot the sensor If the fault persists, call Banner Customer Support Reboot the sensor If the fault persists, call Banner Customer Support |
| 21 | Internal Read Error | <ul style="list-style-type: none"> Reboot the sensor If the fault persists, call Banner Customer Support |
| 22 | Internal Write Error | <ul style="list-style-type: none"> Reboot the sensor If the fault persists, call Banner Customer Support |
| 30 | Laser Power Test Error | <ul style="list-style-type: none"> Reboot the sensor If the fault persists, call Banner Customer Support |
| 31 | Laser Power Read Error | <ul style="list-style-type: none"> Reboot the sensor If the fault persists, call Banner Customer Support |

| Sensor Fault Code | Description | Recommended Solution |
|-------------------|--------------------------|--|
| 32 | Laser Power Write Error | <ul style="list-style-type: none"> Reboot the sensor If the fault persists, call Banner Customer Support |
| 1000 | Acquisition Error 3 | <ul style="list-style-type: none"> Reboot the sensor If the fault persists, call Banner Customer Support |
| 1011–1017 | Internal Flash Error 1–7 | <ul style="list-style-type: none"> Call Banner Customer Support |
| 30000-32000 | Boot Loader Error | <ul style="list-style-type: none"> Call Banner Customer Support |

6.3.2 Configuration Error Codes

The following is a list of possible error codes.

Modbus TCP: The codes are from input register 22 (holding register 1022).

EtherNet/IP: The codes are from word 21 in the PLC Input (ZMX Output) Assembly Instance

| Error Code | Description |
|------------|----------------------------|
| 110 | Illumination Power < 1 |
| 111 | Illumination Power > 100 |
| 120 | Invalid Trigger Mode |
| 130 | Trigger Period < 200 ms |
| 131 | Trigger Period > 60000 ms |
| 140 | Pitch Angle < -4500 |
| 141 | Pitch Angle > 4500 |
| 150 | Roll Angle < -4500 |
| 151 | Roll Angle > 4500 |
| 160 | Yaw Angle < -18000 |
| 161 | Yaw Angle > 18000 |
| 300 | Invalid Discrete Polarity |
| 2000 | Anchor Point X < -2500 mm |
| 2001 | Anchor Point X > 2500 mm |
| 2010 | Anchor Point Y < -2500 mm |
| 2011 | Anchor Point Y > 2500 mm |
| 2020 | Anchor Point Z < -2500 mm |
| 2021 | Anchor Point Z > 2500 mm |
| 2030 | Bin Length X < 50 mm |
| 2031 | Bin Length X > 5000 mm |
| 2040 | Bin Width Y < 50 mm |
| 2041 | Bin Width Y > 5000 mm |
| 2050 | Bin Height Z < 50 mm |
| 2051 | Bin Height Z > 5000 mm |
| 2052 | Invalid Bin Height |
| 2060 | Fill Level Setpoint < 0% |
| 2061 | Fill Level Setpoint > 200% |
| 2080 | Peak Height Setpoint < 0 |

| Error Code | Description |
|-------------------|--|
| 2081 | Peak Height Setpoint > Bin Height Z (mm) |
| 2100 | <i>Discrete Output 1 Selection Invalid</i> |
| 2110 | <i>Discrete Output 2 Selection Invalid</i> |

7 Accessories

7.1 Cordsets

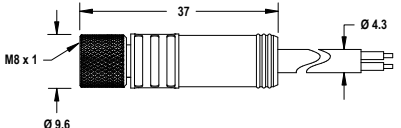
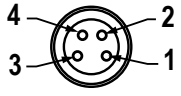
| 4-Pin Threaded M8 Cordsets with Shield for Power and I/O | | | | |
|--|-----------------|----------|--|---|
| Model | Length | Style | Dimensions | Pinout (Female) |
| PKG4MS-2-22 | 2.0 m (6.6 ft) | Straight |  |  <p>1 = Brown 2 = White 3 = Blue 4 = Black</p> |
| PKG4MS-4.6-22 | 4.6 m (15.1 ft) | | | |
| PKG4MS-9.1-22 | 9.1 m (29.9 ft) | | | |

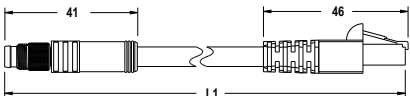
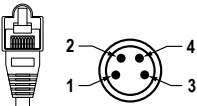
| Double-Ended 4-Pin M8 male to RJ45 male Ethernet and PC communication | | | | |
|---|----------------|----------|--|--|
| Model | Length | Style | Dimensions | Pinout |
| STP-M8MRJ45-406 | 1.83 m (6 ft) | Straight |  |  <p>1 = Blue 2 = White/Blue 3 = White/Orange 4 = Orange</p> |
| STP-M8MRJ45-415 | 4.57 m (15 ft) | | | |
| STP-M8MRJ45-430 | 9.14 m (30 ft) | | | |

7.2 Brackets

SMBZMXMP

- Plate for flush mounting sensor
- 11-gauge stainless steel
- M4 × 0.7 mounting hardware included
- ¼ - 20 thread included for mounting with bogen arm

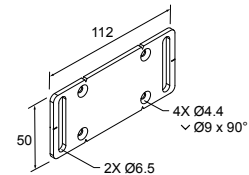

SMBZMXRA

- Right angle mounting bracket, with rotation available
- 12-gauge stainless steel
- M4 × 0.7 mounting hardware included

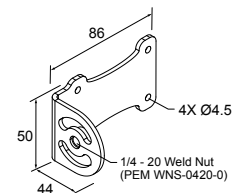

SMBZMXRM

- Recessed mounting bracket
- 12-gauge stainless steel
- M4 × 0.7 mounting hardware included

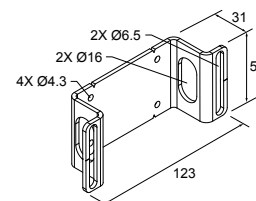

8 Product Support

8.1 Cleaning Instructions

Handle the sensor with care during installation and operation. Sensor windows soiled by fingerprints, dust, water, oil, etc. may create stray light that may degrade the peak performance of the sensor.

Clean as necessary using:

- Optical lens cleaner designed for coated optics
- Optical wipes designed for coated optics

Alternatively, use a soft, clean cloth and isopropyl alcohol or a soft, clean cloth and a mild soap or detergent with lukewarm water. Do not use any other chemicals for cleaning (for example, avoid vinegar or ammonia-based products because they will damage the surface).

Canned air may also be used to blow dust from the sensor.

8.2 Back Up the Sensor

Use the following procedure to create a backup of the ZMX sensor.

1. Connect to the desired sensor.



Note: The sensor can be running, however, consider the status of the connected equipment (for example, the PLC) prior to creating a backup.

2. On the **Sensor Maintenance** pane, click **Backup Device**.
3. Navigate to the desired location.
4. Click **Start**.

All settings, including sensor name, IP address, subnet mask, and gateway are saved. The backup is saved as a .bak file.

8.3 Restore the Sensor

Use the following procedure to restore the ZMX sensor from a saved file.

1. Connect to the desired sensor.



Note: The sensor can be running, however, consider the status of the connected equipment (for example, the PLC) prior to restoring the sensor.

2. On the **Sensor Maintenance** pane, click **Restore Device**.
3. Navigate to the desired .bak file.
4. Select options.
 - a) Select the **Overwrite IP Address, Subnet Mask and Gateway** checkbox (default) if you do not want to keep the current information from the connected sensor.
 - b) Select the **Overwrite Sensor Name** checkbox (default) if you do not want to keep the current sensor name of the connected sensor.
5. Click **Start**.
The sensor settings are restored to those from the .bak file.
6. Reboot the sensor.

8.4 Repairs

Contact Banner Engineering for troubleshooting of this device. **Do not attempt any repairs to this Banner device; it contains no field-replaceable parts or components.** If the device, device part, or device component is determined to be defective by a Banner Applications Engineer, they will advise you of Banner's RMA (Return Merchandise Authorization) procedure.



Important: If instructed to return the device, pack it with care. Damage that occurs in return shipping is not covered by warranty.

8.5 Contact Us

Banner Engineering Corp. headquarters is located at:

9714 Tenth Avenue North
 Minneapolis, MN 55441, USA
 Phone: + 1 888 373 6767

For worldwide locations and local representatives, visit www.bannerengineering.com.

8.6 Banner Engineering Corp. Limited Warranty

Banner Engineering Corp. warrants its products to be free from defects in material and workmanship for one year following the date of shipment. Banner Engineering Corp. will repair or replace, free of charge, any product of its manufacture which, at the time it is returned to the factory, is found to have been defective during the warranty period. This warranty does not cover damage or liability for misuse, abuse, or the improper application or installation of the Banner product.

THIS LIMITED WARRANTY IS EXCLUSIVE AND IN LIEU OF ALL OTHER WARRANTIES WHETHER EXPRESS OR IMPLIED (INCLUDING, WITHOUT LIMITATION, ANY WARRANTY OF MERCHANTABILITY OR FITNESS FOR A PARTICULAR PURPOSE), AND WHETHER ARISING UNDER COURSE OF PERFORMANCE, COURSE OF DEALING OR TRADE USAGE.

This Warranty is exclusive and limited to repair or, at the discretion of Banner Engineering Corp., replacement. **IN NO EVENT SHALL BANNER ENGINEERING CORP. BE LIABLE TO BUYER OR ANY OTHER PERSON OR ENTITY FOR ANY EXTRA COSTS, EXPENSES, LOSSES, LOSS OF PROFITS, OR ANY INCIDENTAL, CONSEQUENTIAL OR SPECIAL DAMAGES RESULTING FROM ANY PRODUCT DEFECT OR FROM THE USE OR INABILITY TO USE THE PRODUCT, WHETHER ARISING IN CONTRACT OR WARRANTY, STATUTE, TORT, STRICT LIABILITY, NEGLIGENCE, OR OTHERWISE.**

Banner Engineering Corp. reserves the right to change, modify or improve the design of the product without assuming any obligations or liabilities relating to any product previously manufactured by Banner Engineering Corp. Any misuse, abuse, or improper application or installation of this product or use of the product for personal protection applications when the product is identified as not intended for such purposes will void the product warranty. Any modifications to this product without prior express approval by Banner Engineering Corp will void the product warranties. All specifications published in this document are subject to change; Banner reserves the right to modify product specifications or update documentation at any time. Specifications and product information in English supersede that which is provided in any other language. For the most recent version of any documentation, refer to: www.bannerengineering.com.

For patent information, see www.bannerengineering.com/patents.

8.7 Banner Engineering Corp. Software Copyright Notice

© Banner Engineering Corp., All Rights Reserved.

<https://www.bannerengineering.com/us/en/company/terms-and-conditions.html>

Disclaimer of Warranties. This software is provided "AS-IS." To the maximum extent permitted by applicable law, Banner, its affiliates, and its channel partners disclaim all warranties, expressed or implied, including any warranty that the software is fit for a particular purpose, title, merchantability, data loss, non-interference with or non-infringement of any intellectual property rights, or the accuracy, reliability, quality or content in or linked to the services. Banner and its affiliates and channel partners do not warrant that the services are secure, free from bugs, viruses, interruption, errors, theft or destruction. If the exclusions for implied warranties do not apply to you, any implied warranties are limited to 60 days from the date of first use of this software.

Limitation of Liability and Indemnity. Banner, its affiliates and channel partners are not liable for indirect, special, incidental, punitive or consequential damages, damages relating to corruption, security, loss or theft of data, viruses, spyware, loss of business, revenue, profits, or investment, or use of software or hardware that does not meet Banner minimum systems requirements. The above limitations apply even if Banner and its affiliates and channel partners have been advised of the possibility of such damages. This Agreement sets forth the entire liability of Banner, its affiliates and your exclusive remedy with respect to the software use.

Index

3D camera view 12

A

amp 12
amplitude 11
auto 12

B

backup 18, 48
blue is far 12
blue is near 12
bubble level 12

C

clip 12
connection pane 13
cursor(x,y) 13

D

default 18, 23
DHCP 17
discrete output 17
DOUT1 15, 17

E

error code 44
EtherNet/IP 17

F

factory default 23
fault code 44
fill level pane 15, 17
firmware 18

G

grayscale overlays distance 12

H

height 15, 17

horizontal flip mode 12

I

image center crosshairs 12
image pane 11, 13, 15, 17, 18
image pane parameters 11
indicator 3
input bits 38, 40
input bits, Modbus TCP 39

L

live protocol map 17
load 11, 13, 15, 17, 18

M

Modbus TCP 17, 39
mode
 trigger 13, 14
model 18

O

output
 discrete 17
output bits, Modbus TCP 39

P

pane
 fill level 15, 17
 image 11, 13, 15, 17, 18
 sensor 13
 sensor controls 13
 sensor maintenance 18
PC requirements 21
peak height 15, 17
pitch 14
points 11
points outside of the application 3D
 space 12
Pulse Pro 15, 17

R

red is far 12

red is near 12
region of interest 15, 17
reset 3D camera view 12
restore 18, 48
restore defaults 23
roll 14

S

save 11, 13, 15, 17, 18
sensor controls pane 13
sensor maintenance pane 18
show or hide 3D camera 12
software 11, 13, 15, 17, 18
status indicator 3
surface 11

T

toggle 3D point cloud 12
trigger 11, 13, 15, 17, 18
trigger mode 13, 14

V

vertical flip mode 12
view parameters 11
volume 15, 17

W

working volume sidewalls 12

X

X(mm) 13

Y

Y(mm) 13
yaw 14

Z

Z(mm) 11