

DELIVERY SPECIFICATION

SPEC. No. C2020-FA

D A T E : 2020 April

To

Non-Controlled Copy

CUSTOMER'S PRODUCT NAME	TDK'S PRODUCT NAME Multilayer Ceramic Capacitors Dipped Radial Lead Type FA-Series General (Up to 50V) Mid voltage (100 to 630V) 【Halogen-free, RoHS compliant】
-------------------------	---

Please return this specification to TDK representatives with your signature.
If orders are placed without returned specification, please allow us to judge that specification is accepted by your side.

RECEIPT CONFIRMATION

DATE: YEAR MONTH DAY

TDK Corporation
Sales
Electronic Components
Sales & Marketing Group

Engineering
Electronic Components Business Company
Ceramic Capacitors Business Group

APPROVED	Person in charge

APPROVED	CHECKED	Person in charge

SCOPE

This delivery specification shall be applied to Multilayer ceramic chip capacitors to be delivered to _____.

PRODUCTION PLACES

Production places defined in this specification shall be TDK Xiamen Co., (China).

PRODUCT NAME

The name of the product to be defined in this specifications shall be FA○○△△△□□□×××◎****.

REFERENCE STANDARD

JIS	C 5101-1	Fixed capacitors for use in electronic equipment-Part 1 : Generic specification
	C 0806-2	Packaging of components for automatic handing-Part 2 : Packaging of components with unidirectional leads on continuous tapes
JEITA	RCR-2335 C	Safety application guide for fixed ceramic capacitors for use in electronic equipment

CONTENTS

1. CODE CONSTRUCTION
2. COMBINATION OF RATED CAPACITANCE AND TOLERANCE
3. OPERATING TEMPERATURE RANGE
4. STORING CONDITION AND TERM
5. INDUSTRIAL WASTE DISPOSAL
6. PERFORMANCE
7. INDICATION
8. INSIDE STRUCTURE AND MATERIAL
9. PACKAGING
10. CAUTION
11. TAPE PACKAGING SPECIFICATION

<EXPLANATORY NOTE>

When the mistrust in the spec arises, this specification is given priority. And it will be confirmed by written spec change after conference of both posts involved.

This specification warrants the quality of the ceramic chip capacitor. Capacitors should be evaluated or confirmed a state of mounted on your product.

If the use of the capacitors goes beyond the bounds of this specification, we can not afford to guarantee.

Division	Date	SPEC. No.
Ceramic Capacitors Business Group	Apr., 2020	C2020-FA

1. CODE CONSTRUCTION

(Example) FA28 X7R 1H 104 K NU0 6
 (1) (2) (3) (4) (5) (6) (7)

(1) Case size

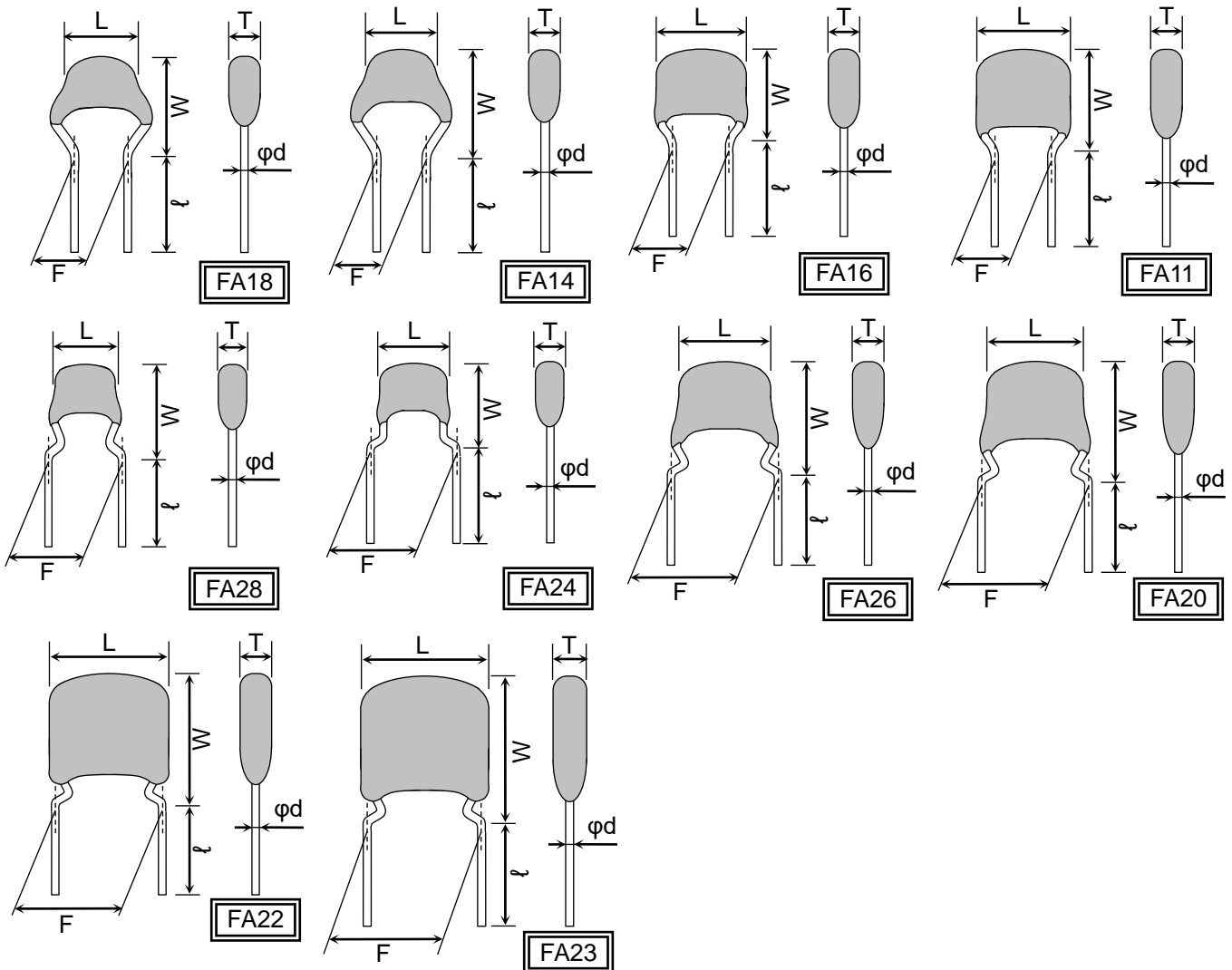

Case size *1	Dimensions (mm)					
	L(max.) *2	W(max.)	T(max.)	F *3	l *3	φd
FA18	4.0	5.5	2.5	2.5±0.8	7.0±2.0	0.5 ^{+0.10} -0.03
FA14	4.5	5.5	3.0			
FA16	5.5	6.0	3.5			
FA11	5.5	7.0	4.0			
FA28	4.0	5.5	2.5	5.0±1.0	7.0±2.0	0.5 ^{+0.10} -0.03
FA24	4.5	5.5	3.0			
FA26	5.5	6.0	3.5			
FA20	5.5	7.0	4.0			
FA22	7.5	8.5	4.5			
FA23	8.5	11.0	5.5			

*1 FA denotes forming lead.

The first digit refers to a distance between leads (1:2.5mm, 2:5.0mm), the second digit is for TDK internal code.

*2 The FA18, FA14, FA28 and FA24 types represent dimensions 1 mm below the top of the body.

Other types represent the dimensions of the central part of the body.

*3 Dimension F and l is applied to bulk packaging.

The measurement point of F dimensions is 1.5 to 2.0mm below the kink.

Refer to Appendix 2 and 3 for dimension of taping packaging.

(2) Temperature Characteristics (Details are shown in para 6 No.7,8)

(3) Rated Voltage

Symbol	Rated Voltage
2 J	DC 630 V
2 W	DC 450 V
2 E	DC 250 V
2 A	DC 100 V
1 H	DC 50 V
1 E	DC 25 V
1 C	DC 16 V
1 A	DC 10 V
0 J	DC 6.3 V

(4) Rated Capacitance

Stated in three digits and in units of pico farads (pF). The first and second digits identify the first and second significant figures of the capacitance, the third digit identifies the multiplier. R is designated for a decimal point.

(Example)

Symbol	Rated Capacitance
2R2	2.2pF
104	100,000pF

(5) Capacitance tolerance

Symbol	Tolerance	Capacitance(C)
C	±0.25 pF	$C \leq 5\text{pF}$
D	±0.5 pF	$5\text{pF} < C \leq 10\text{pF}$
J	± 5 %	Over 10pF
K	±10 %	
M	±20 %	

(6) Internal code

Symbol	Applied voltage of Life
NU0	Rated voltage ×2 (*1)
RU0	Rated voltage ×1

*1 2E : Rated voltage×1.5
 2W : Rated voltage×1.2
 2J : Rated voltage×1.2

(7) Packaging

Symbol	Packaging
0	Bulk
6	Ammo Pack

2. COMBINATION OF RATED CAPACITANCE AND TOLERANCE

Class	Temperature Characteristics	Capacitance tolerance		Rated capacitance(C)
1	C0G	$C \leq 5 \text{ pF}$	C ($\pm 0.25 \text{ pF}$)	E- 6 series
		$5 \text{ pF} < C \leq 10 \text{ pF}$	D ($\pm 0.5 \text{ pF}$)	E- 6 series
		$10 \text{ pF} < C \leq 100 \text{ pF}$	J ($\pm 5 \%$)	E- 6 series
		$100 \text{ pF} < C \leq 10,000 \text{ pF}$	J ($\pm 5 \%$)	E-12 series
		$10,000 \text{ pF} < C$	J ($\pm 5 \%$)	E- 6 series
2	X7R X7S X7T	$C \leq 10\mu\text{F}$	K ($\pm 10 \%$)	E- 6 series
		$10\mu\text{F} < C$	M ($\pm 20 \%$)	E- 6 series

Capacitance Step in E series

E series	Capacitance Step											
E- 6	1.0		1.5		2.2		3.3		4.7		6.8	
E-12	1.0	1.2	1.5	1.8	2.2	2.7	3.3	3.9	4.7	5.6	6.8	8.2

3. OPERATING TEMPERATURE RANGE

T.C.	Min. operating Temperature	Max. operating Temperature	Reference Temperature
C0G X7R X7S X7T	-55°C	125°C	25°C

4. STORING CONDITION AND TERM

Storing temperature	Storing humidity	Storing term
5~40°C	20~70%RH	Within 6 months upon receipt.

5. INDUSTRIAL WASTE DISPOSAL

Dispose this product as industrial waste in accordance with the industrial Waste Law.

6. PERFORMANCE

table 1

No.	Item		Performance	Test or inspection method															
1	External Appearance		No defects which may affect performance.	By visual checking.															
2	Indication	Appearance	Meet a requirement per para 7.	solvent	Solvent temp.	Dipping time													
		Resistance to solvent	Shall be visible.	Isopropyl alcohol	20~25°C	30±5s.													
3	Voltage Proof	Between termination	No insulation breakdown or other damage.	<table border="1"> <thead> <tr> <th>Class</th> <th>Rated voltage</th> <th>Apply voltage</th> </tr> </thead> <tbody> <tr> <td rowspan="2">1</td> <td>100V and under</td> <td>3 × rated voltage</td> </tr> <tr> <td>Over 100V</td> <td>1.5 × rated voltage</td> </tr> <tr> <td rowspan="2">2</td> <td>RV ≤ 100V</td> <td>2.5 × rated voltage</td> </tr> <tr> <td>Over 100V</td> <td>1.5 × rated voltage</td> </tr> </tbody> </table> <p>Above DC voltage shall be applied for 1~5s. Charge / discharge current shall not exceed 50mA.</p>			Class	Rated voltage	Apply voltage	1	100V and under	3 × rated voltage	Over 100V	1.5 × rated voltage	2	RV ≤ 100V	2.5 × rated voltage	Over 100V	1.5 × rated voltage
		Class	Rated voltage	Apply voltage															
1	100V and under	3 × rated voltage																	
	Over 100V	1.5 × rated voltage																	
2	RV ≤ 100V	2.5 × rated voltage																	
	Over 100V	1.5 × rated voltage																	
		Between termination coating	No insulation breakdown or other damage.	Apply ×2.5 rated voltage. (By metallic small ball method.)															
4	Insulation Resistance		10,000MΩ or 500 MΩ · μF min. whichever smaller.	«450V DC and under» Apply rated voltage. «630V DC» Apply DC500V. Applying time : 60sec.															
5	Capacitance		Within the specified tolerance.	Class 1															
				Rated capacitance	Measuring frequency	Measuring voltage													
						0.5~5 Vrms.													
			1,000pF and under	1MHz±10%															
			Over 1,000pF	1kHz±10%															
				Class 2															
				Rated capacitance	Measuring frequency	Measuring voltage													
				10μF and under	1kHz±10%	1.0±0.2 Vrms.													
				Over 10μF	120Hz±20%	0.5±0.2 Vrms.													
				For information which product has which measuring voltage, please contact with our sales representative.															

(continued)

No.	Item		Performance	Test or inspection method															
6	Q (Class 1)		<table border="1"> <thead> <tr> <th>Capacitance</th> <th>Q</th> </tr> </thead> <tbody> <tr> <td>30pF and over</td> <td>1,000 min.</td> </tr> <tr> <td>Under 30pF</td> <td>400+20xC min.</td> </tr> </tbody> </table> <p>C : Rated capacitance (pF)</p>	Capacitance	Q	30pF and over	1,000 min.	Under 30pF	400+20xC min.	<p>See No.5 in this table for measuring condition.</p> <p>For information which product has which Dissipation Factor, please contact with our sales representative.</p>									
	Capacitance	Q																	
30pF and over	1,000 min.																		
Under 30pF	400+20xC min.																		
Dissipation Factor (Class 2)		<table border="1"> <thead> <tr> <th>T.C.</th> <th>D.F.</th> </tr> </thead> <tbody> <tr> <td>X7R</td> <td>0.03 max.</td> </tr> <tr> <td>X7S</td> <td>0.05 max.</td> </tr> <tr> <td>X7T</td> <td>0.075 max.</td> </tr> </tbody> </table>	T.C.	D.F.	X7R	0.03 max.	X7S	0.05 max.	X7T	0.075 max.									
T.C.	D.F.																		
X7R	0.03 max.																		
X7S	0.05 max.																		
X7T	0.075 max.																		
7	Temperature Characteristics of Capacitance (Class 1)		<table border="1"> <thead> <tr> <th>Temperature Coefficient (ppm/°C)</th> </tr> </thead> <tbody> <tr> <td>C0G : 0 ± 30</td> </tr> </tbody> </table> <p>Capacitance drift Within ±0.2% or ±0.05pF, whichever larger.</p>	Temperature Coefficient (ppm/°C)	C0G : 0 ± 30	<p>Temperature Coefficient shall be calculated based on values at 25°C and 85°C temperature.</p> <p>Measuring temperature below 20°C shall be -10°C and -25°C</p>													
Temperature Coefficient (ppm/°C)																			
C0G : 0 ± 30																			
8	Temperature Characteristics of Capacitance (Class 2)		<table border="1"> <thead> <tr> <th>Capacitance Change(%)</th> </tr> </thead> <tbody> <tr> <td>No voltage applied</td> </tr> <tr> <td>X7R : ±15</td> </tr> <tr> <td>X7S : ±22</td> </tr> <tr> <td>X7T : +22, -33</td> </tr> </tbody> </table>	Capacitance Change(%)	No voltage applied	X7R : ±15	X7S : ±22	X7T : +22, -33	<p>Capacitance shall be measured by the steps shown in the following table, after thermal equilibrium is obtained for each step.</p> <p>ΔC be calculated ref. STEP3 reading.</p> <table border="1"> <thead> <tr> <th>Step</th> <th>Temperature(°C)</th> </tr> </thead> <tbody> <tr> <td>1</td> <td>Reference temp. ±2</td> </tr> <tr> <td>2</td> <td>Min. operating temp. ±2</td> </tr> <tr> <td>3</td> <td>Reference temp. ±2</td> </tr> <tr> <td>4</td> <td>Max. operating temp. ±2</td> </tr> </tbody> </table> <p>Measuring voltage: 0.5, 1.0Vrms. For information which product has which applied voltage, please contact with our sales representative.</p>	Step	Temperature(°C)	1	Reference temp. ±2	2	Min. operating temp. ±2	3	Reference temp. ±2	4	Max. operating temp. ±2
Capacitance Change(%)																			
No voltage applied																			
X7R : ±15																			
X7S : ±22																			
X7T : +22, -33																			
Step	Temperature(°C)																		
1	Reference temp. ±2																		
2	Min. operating temp. ±2																		
3	Reference temp. ±2																		
4	Max. operating temp. ±2																		
9	Lead Strength	Tensile Strength	No mechanical damage such as lead breakage and loosing.	<p>With holding the parts, apply pulling force to lead drawing direction gradually. Pulling strength : 10N Holding time : 10±1s.</p> <p>With holding the capacitors to keep the axis vertical, bend it 90 degrees with weighting and put it back to the original position. This operation shall be done for 2~3s. and repeat the following times. Bending forth : 5N Testing time : 2 times</p>															
		Bending Strength	No mechanical damage such as lead breakage and loosing.																

(continued)

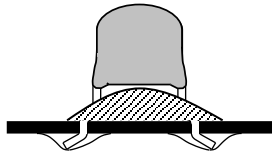
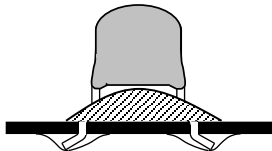
No.	Item	Performance	Test or inspection method									
10	Mechanical Shock	No mechanical damage.	With following conditions.									
	External appearance		Waveform : Half-sine Applied force : 100G max. Velocity change : 12.3ft/s. Duration : 6 msec. Shocks : 18shocks in each 3 mutually perpendicular axes.									
	Capacitance	<table border="1" data-bbox="520 300 951 562"> <thead> <tr> <th colspan="2">Characteristics</th> <th>Change from the value before test</th> </tr> </thead> <tbody> <tr> <td>Class 1</td> <td>C0G</td> <td>±2.5% or ±0.25pF, whichever larger.</td> </tr> <tr> <td>Class 2</td> <td>X7R X7S X7T</td> <td>±7.5 %</td> </tr> </tbody> </table>	Characteristics		Change from the value before test	Class 1	C0G	±2.5% or ±0.25pF, whichever larger.	Class 2	X7R X7S X7T	±7.5 %	Solder the capacitors on a P.C.Board shown in Appendix1 before testing. The FA23 type fixes the capacitors with coating as follows.
	Characteristics		Change from the value before test									
Class 1	C0G	±2.5% or ±0.25pF, whichever larger.										
Class 2	X7R X7S X7T	±7.5 %										
Q Class1	Meet the initial spec.											
D.F. Class2	Meet the initial spec.											
11	Vibration	No mechanical damage.	Vibrate the capacitor with following conditions.									
	External appearance		Applied force : 5G max. Frequency : 10-2,000-10Hz Duration : 20 min. Cycle : 12cycles in each 3 mutually perpendicular directions.									
	Capacitance	<table border="1" data-bbox="520 875 951 1115"> <thead> <tr> <th colspan="2">Characteristics</th> <th>Change from the value before test</th> </tr> </thead> <tbody> <tr> <td>Class 1</td> <td>C0G</td> <td>±2.5% or ±0.25pF, whichever larger.</td> </tr> <tr> <td>Class 2</td> <td>X7R X7S X7T</td> <td>±7.5 %</td> </tr> </tbody> </table>	Characteristics		Change from the value before test	Class 1	C0G	±2.5% or ±0.25pF, whichever larger.	Class 2	X7R X7S X7T	±7.5 %	Solder the capacitors on a P.C.Board shown in Appendix1 before testing. The FA23 type fixes the capacitors with coating as follows.
	Characteristics		Change from the value before test									
Class 1	C0G	±2.5% or ±0.25pF, whichever larger.										
Class 2	X7R X7S X7T	±7.5 %										
Q Class1	Meet the initial spec.											
D.F. Class2	Meet the initial spec.											
12	Solderability	Leads shall be covered by new solder more than 75% of its surface.	<p>Completely soak both terminations in solder at 245±5°C for 2±0.5s.</p> <p>Solder : Sn-3.0Ag-0.5Cu(Pb-free) Flux : Isopropyl alcohol(JIS K 8839) Rosin(JIS K 5902) 25% solid solution. Dipping : By 1.5~2.0mm from the root of lead.</p>									

(continued)

No.	Item	Performance	Test or inspection method									
13	Resistance to solder heat	No defects which may affect performance.	Completely soak both terminations in solder at 260±5°C for 10±1s. Solder : Sn-3.0Ag-0.5Cu(Pb-free) Flux : Isopropyl alcohol(JIS K 8839) Rosin(JIS K 5902) 25% solid solution. Dipping : By 1.5~2.0mm from the root of lead. Leave the capacitors in ambient condition for the following time before measurement. Class1 : 6~24h Class2 : 24±2h									
	External appearance											
	Capacitance	<table border="1"> <thead> <tr> <th colspan="2">Characteristics</th> <th>Change from the value before test</th> </tr> </thead> <tbody> <tr> <td>Class 1</td> <td>C0G</td> <td>±2.5 % or ±0.25pF whichever larger.</td> </tr> <tr> <td>Class 2</td> <td>X7R X7S X7T</td> <td>±7.5 %</td> </tr> </tbody> </table>		Characteristics		Change from the value before test	Class 1	C0G	±2.5 % or ±0.25pF whichever larger.	Class 2	X7R X7S X7T	±7.5 %
	Characteristics			Change from the value before test								
	Class 1	C0G		±2.5 % or ±0.25pF whichever larger.								
Class 2	X7R X7S X7T	±7.5 %										
Q Class1	Meet the initial spec.											
D.F. Class2	Meet the initial spec.											
Insulation Resistance	Meet the initial spec.											
Voltage proof	No insulation breakdown or other damage.											
14	Heat shock	No mechanical damage.	Solder the capacitors on a P.C.Board shown in Appendix1 before testing. Expose the capacitors in the condition step1 through 2. <table border="1"> <thead> <tr> <th>Step</th> <th>Temp.(°C)</th> <th>Time(min.)</th> </tr> </thead> <tbody> <tr> <td>1</td> <td>Min. operating Temp.±3</td> <td>30 ± 3</td> </tr> <tr> <td>2</td> <td>Max. operating Temp.±2</td> <td>30 ± 2</td> </tr> </tbody> </table> Test cycle : 1,000cycles Transit time : Less than 1min. Leave the capacitors in ambient condition for the following time before measurement. Class1 : 6~24h Class2 : 24±2h	Step	Temp.(°C)	Time(min.)	1	Min. operating Temp.±3	30 ± 3	2	Max. operating Temp.±2	30 ± 2
	Step	Temp.(°C)		Time(min.)								
	1	Min. operating Temp.±3		30 ± 3								
	2	Max. operating Temp.±2		30 ± 2								
	External appearance											
Capacitance	<table border="1"> <thead> <tr> <th colspan="2">Characteristics</th> <th>Change from the value before test</th> </tr> </thead> <tbody> <tr> <td>Class 1</td> <td>C0G</td> <td>±2.5 % or ±0.25pF whichever larger.</td> </tr> <tr> <td>Class 2</td> <td>X7R X7S X7T</td> <td>±7.5 %</td> </tr> </tbody> </table>	Characteristics		Change from the value before test	Class 1	C0G	±2.5 % or ±0.25pF whichever larger.	Class 2	X7R X7S X7T	±7.5 %		
Characteristics		Change from the value before test										
Class 1	C0G	±2.5 % or ±0.25pF whichever larger.										
Class 2	X7R X7S X7T	±7.5 %										
Q Class1	Meet the initial spec.											
D.F. Class2	Meet the initial spec.											
Insulation Resistance	Meet the initial spec.											
Voltage proof	No insulation breakdown or other damage.											

(continued)

No.	Item	Performance	Test or inspection method									
15	Moisture Resistance	No mechanical damage.	Solder the capacitors on a P.C.Board shown in Appendix1 before testing.									
	Capacitance	<table border="1"> <thead> <tr> <th colspan="2">Characteristics</th> <th>Change from the value before test</th> </tr> </thead> <tbody> <tr> <td>Class 1</td> <td>C0G</td> <td>$\pm 7.5\%$ or $\pm 0.75\text{pF}$ whichever larger.</td> </tr> <tr> <td>*Class 2</td> <td>X7R X7S X7T</td> <td>$\pm 12.5\%$ $\pm 25\%$</td> </tr> </tbody> </table>	Characteristics		Change from the value before test	Class 1	C0G	$\pm 7.5\%$ or $\pm 0.75\text{pF}$ whichever larger.	*Class 2	X7R X7S X7T	$\pm 12.5\%$ $\pm 25\%$	Apply the rated voltage at temperature $85\pm 2^\circ\text{C}$ and 85%RH for 1,000 +48,0h.
		Characteristics		Change from the value before test								
	Class 1	C0G	$\pm 7.5\%$ or $\pm 0.75\text{pF}$ whichever larger.									
	*Class 2	X7R X7S X7T	$\pm 12.5\%$ $\pm 25\%$									
		Charge/discharge current shall not exceed 50mA.										
		Leave the capacitors in ambient condition for the following time before measurement.										
	Q Class1	<table border="1"> <thead> <tr> <th>Capacitance</th> <th>Q</th> </tr> </thead> <tbody> <tr> <td>30pF and over</td> <td>200 min.</td> </tr> <tr> <td>Under 30pF</td> <td>$100+10/3\times C$ min.</td> </tr> </tbody> </table> <p>C : Rated capacitance (pF)</p>	Capacitance	Q	30pF and over	200 min.	Under 30pF	$100+10/3\times C$ min.	Class1 : 6~24h Class2 : 24 \pm 2h			
Capacitance	Q											
30pF and over	200 min.											
Under 30pF	$100+10/3\times C$ min.											
	D.F. Class2	200% of initial spec max.	Voltage conditioning : (Only Class2) Voltage treat the capacitor under testing temperature and voltage for 1hour.									
	Insulation Resistance	500M Ω or 25M Ω · μF min. whichever smaller.	Leave the capacitors in ambient condition for 24 \pm 2h before measurement. Use this measurement for initial value.									
16	Life	No mechanical damage.	Solder the capacitors on a P.C.Board shown in Appendix1 before testing.									
	Capacitance	<table border="1"> <thead> <tr> <th colspan="2">Characteristics</th> <th>Change from the value before test</th> </tr> </thead> <tbody> <tr> <td>Class 1</td> <td>C0G</td> <td>$\pm 3\%$ or $\pm 0.3\text{pF}$ whichever larger.</td> </tr> <tr> <td>*Class 2</td> <td>X7R X7S X7T</td> <td>$\pm 15\%$ $\pm 25\%$</td> </tr> </tbody> </table>	Characteristics		Change from the value before test	Class 1	C0G	$\pm 3\%$ or $\pm 0.3\text{pF}$ whichever larger.	*Class 2	X7R X7S X7T	$\pm 15\%$ $\pm 25\%$	Below the voltage shall be applied at maximum operating temperature $\pm 2^\circ\text{C}$ for 1,000 +48,0h.
		Characteristics		Change from the value before test								
	Class 1	C0G	$\pm 3\%$ or $\pm 0.3\text{pF}$ whichever larger.									
	*Class 2	X7R X7S X7T	$\pm 15\%$ $\pm 25\%$									
		<table border="1"> <tbody> <tr> <td>Applied voltage</td> </tr> <tr> <td>Rated voltage x2</td> </tr> <tr> <td>Rated voltage x1.5</td> </tr> <tr> <td>Rated voltage x1.2</td> </tr> <tr> <td>Rated voltage x1</td> </tr> </tbody> </table>	Applied voltage	Rated voltage x2	Rated voltage x1.5	Rated voltage x1.2	Rated voltage x1					
Applied voltage												
Rated voltage x2												
Rated voltage x1.5												
Rated voltage x1.2												
Rated voltage x1												
	Q Class1	<table border="1"> <thead> <tr> <th>Capacitance</th> <th>Q</th> </tr> </thead> <tbody> <tr> <td>30pF and over</td> <td>350 min.</td> </tr> <tr> <td>10pF and over under 30pF</td> <td>$275+5/2\times C$ min.</td> </tr> <tr> <td>Under 10pF</td> <td>$200+10\times C$ min.</td> </tr> </tbody> </table> <p>C : Rated capacitance (pF)</p>	Capacitance	Q	30pF and over	350 min.	10pF and over under 30pF	$275+5/2\times C$ min.	Under 10pF	$200+10\times C$ min.	For information which products has which applied voltage, please contact with our sales representative.	
Capacitance	Q											
30pF and over	350 min.											
10pF and over under 30pF	$275+5/2\times C$ min.											
Under 10pF	$200+10\times C$ min.											
	D.F. Class2	200% of initial spec max.	Charge/discharge current shall not exceed 50mA. Leave the capacitors in ambient condition for the following time before measurement.									
	Insulation Resistance	1,000M Ω or 50 M Ω · μF min. whichever smaller.	Class1 : 6~24h Class2 : 24 \pm 2h Voltage conditioning : (Only Class2) Voltage treat the capacitor under testing temperature and voltage for 1hour. Leave the capacitors in ambient condition for 24 \pm 2h before measurement. Use this measurement for initial value.									

* As for the initial measurement of capacitors (Class2) on number 8, 10, 11, 13, and 14, leave capacitors at 150 -10,0°C for 1h and measure the value after leaving capacitors for 24 \pm 2h in ambient condition.

Appendix1

P.C. board

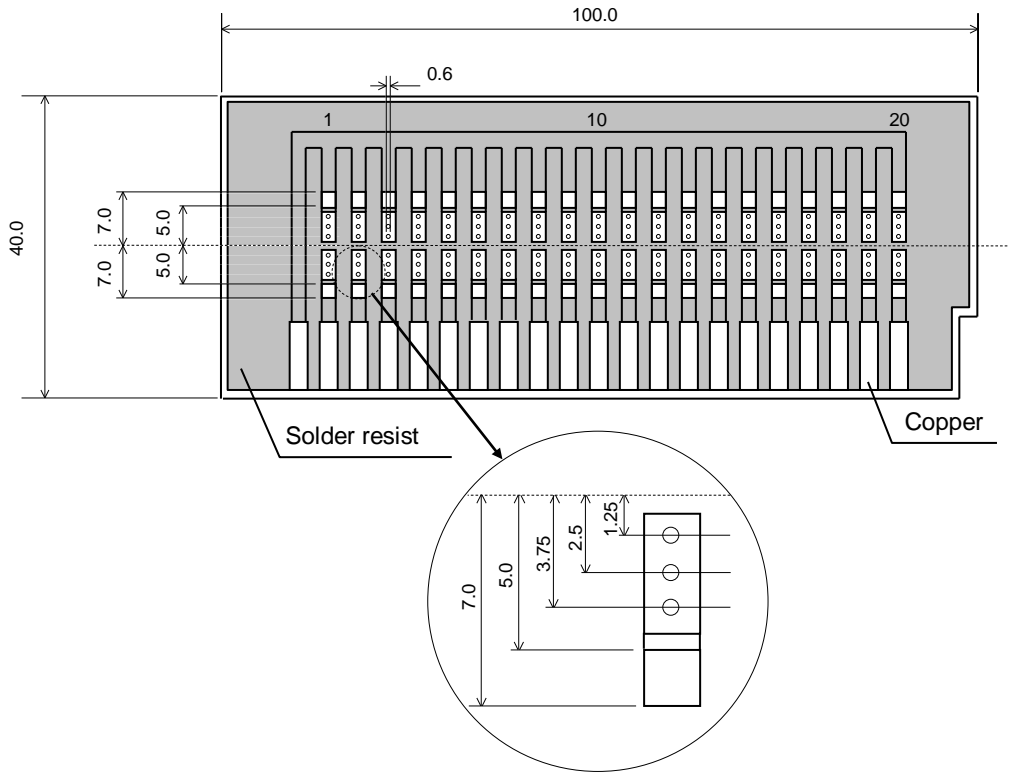

(Unit : mm)

1. Material : Glass Epoxy(As per JIS C6484 GE4)

2. Thickness : 1.6mm

 Copper(Thickness:0.035mm)

 Solder resist

7. INDICATION

7.1 Indication (Example)

Type T.C.	FA18 FA28	FA14 FA24	FA16 FA26	FA11 FA20	FA22	FA23
C0G	(1) → 333		(1) → 104J ← (2) (3) ↗		(1) → 224J ← (2) (3) ↗ TDK ← (4)	
X5R X7R X7S X7T	(1) → 104		(1) → 155K ← (2) (3) ↗		(1) → 335K ← (2) (3) ↗ TDK ← (4)	

7.2 Meaning of indication

No.	Item	Detail
(1)	Rated Capacitance	Indicate in three digits.
(2)	Capacitance tolerance	Indicates the symbol.
(3)	Rated voltage	For DC50V, indicate a bar under the rated capacitance.
(4)	Manufacturer	Indicates " TDK ".

8. INSIDE STRUCTURE AND MATERIAL

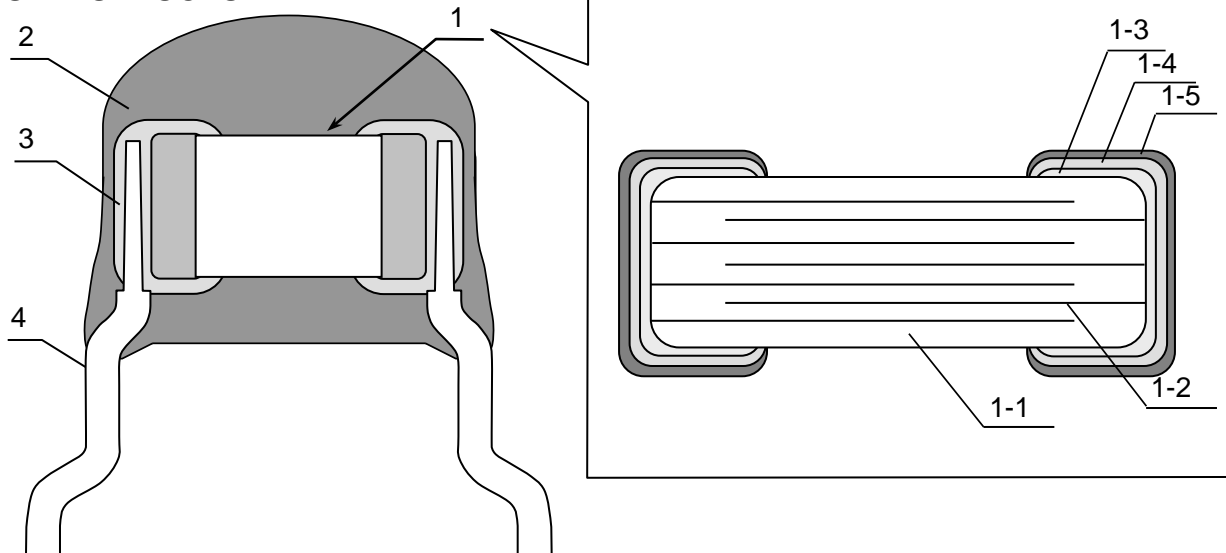

No.	NAME	No.	NAME	MATERIAL	
				Class 1	Class 2
1	Multilayer Ceramic Chip Capacitors	1-1	Dielectric	CaZrO ₃	BaTiO ₃
		1-2	Electrode	Ni	
		1-3	Termination	Cu	
		1-4		Ni	
		1-5		Sn	
2	Coating			Epoxy 【Halogen-free】	
3	Solder for joint			Lead free solder	
4	Lead wire			Tin plated copper covers steel wire	

9. PACKAGING

Packaging shall be done to protect the components from the damage during Transportation and storing, and a label which has the following information shall be attached.

- 1) Inspection No. *
- 2) TDK P/N
- 3) Quantity

* Composition of Inspection No.

Example X 0 A - 00 - 000
 (a) (b) (c) (d) (e)

- a) Inspection factory code
- b) Last digit of year
- c) Month and A for January and B for February and so on. (Skip I)
- d) Inspection Date of the month.
- e) Serial No. of the day

- 1) Total number of components in a plastic bag.

Type	Qty.(pcs.)
FA18, FA28 FA14, FA24 FA16, FA26 FA11, FA20 FA22	500
FA23	200

- 2) Tape packaging is as per TDK tape packaging specification.

10. CAUTION

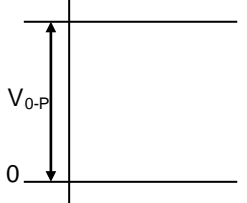
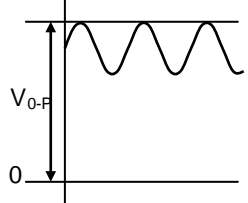
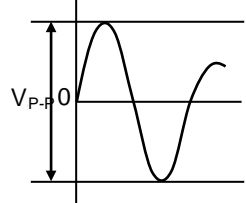
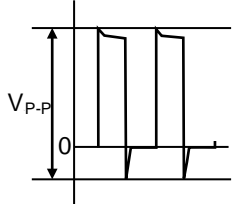
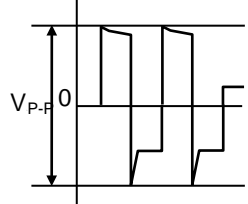
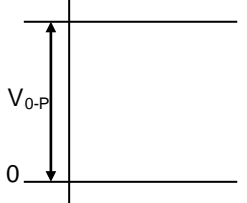
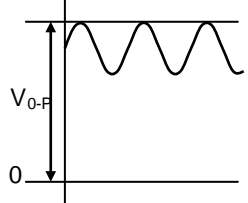
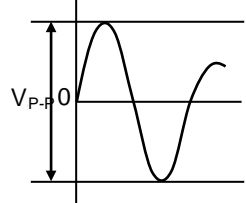
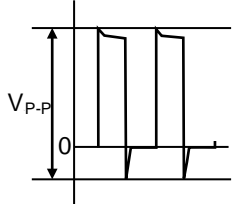
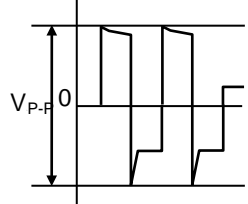
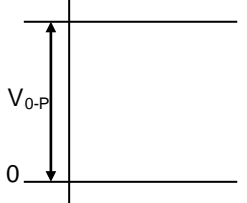
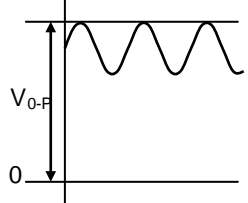
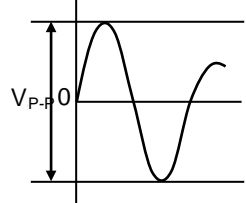
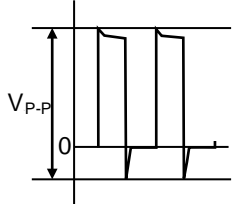
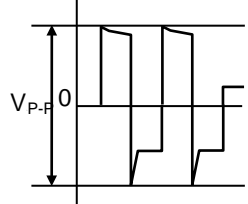
No.	Process	Condition																
1	Operating Condition (Storage, Use, Transportation)	<p>1-1. Storage, Use</p> <ol style="list-style-type: none"> 1) The capacitor must be stored in an ambient temperature of 5~40°C with a relative humidity of 20~70%. The products should be used within 6 months upon receipt. 2) The capacitors must be operated and stored in an environment free of dew condensation and these gases such as Hydrogen Sulphide, Hydrogen Sulphate, Chlorine, Ammonia and sulfur. 3) Avoid storing in sun light and wet with dew. 4) Do not use capacitors under high humidity and high and low atmospheric pressure which may affect capacitors reliability. 5) Capacitors should be tested for the solderability when they are stored for long time. <p>1-2. Handling in transportation</p> <ol style="list-style-type: none"> 1) In case of the transportation of the capacitors, the performance of the capacitors may be deteriorated depending on the transportation condition. (Refer to JEITA RCR-2335C 9.2 Handling in transportation) 																
2	Circuit design  Caution	<p>2-1. Operating temperature</p> <p>Operating temperature should be followed strictly within this specification, especially be careful with the maximum temperature.</p> <ol style="list-style-type: none"> 1) Do not use capacitor above the maximum allowable operating temperature. 2) Surface temperature including self heating should be below maximum operating temperature. (Due to dielectric loss, capacitor will heat itself when AC is applied. Especially at high frequencies around its SRF, the heat might be so extreme that it may damage itself or the product mounted on. Please design the circuit so that the maximum temperature of the capacitor including the self heating to be below the maximum allowable operating temperature. Temperature rise shall be below 20°C.) 3) The electrical characteristics of the capacitors will vary depending on the temperature. The capacitors should be selected and designed in taking the temperature into consideration. <p>2-2. Operating voltage</p> <ol style="list-style-type: none"> 1) Operating voltage across the terminals should be below the rated voltage. When AC and DC are super imposed, V_{0-P} must be below the rated voltage. _____ (1) and (2) AC or pulse with overshooting, V_{P-P} must be below the rated voltage. _____ (3), (4) and (5) <p>When the voltage is started to apply to the circuit or it is stopped applying, the irregular voltage may be generated for a transit period because of resonance or switching. Be sure to use a capacitor within rated voltage containing these irregular voltage.</p> <table border="1" data-bbox="446 1541 1444 2060"> <thead> <tr> <th data-bbox="446 1541 646 1574">Voltage</th> <th data-bbox="646 1541 909 1574">(1) DC voltage</th> <th data-bbox="909 1541 1173 1574">(2) DC + AC voltage</th> <th data-bbox="1173 1541 1444 1574">(3) AC voltage</th> </tr> </thead> <tbody> <tr> <td data-bbox="446 1574 646 1798">Positional Measurement (Rated voltage)</td> <td data-bbox="646 1574 909 1798">  </td> <td data-bbox="909 1574 1173 1798">  </td> <td data-bbox="1173 1574 1444 1798">  </td> </tr> <tr> <th data-bbox="446 1809 646 1843">Voltage</th> <th data-bbox="646 1809 909 1843">(4) Pulse voltage (A)</th> <th data-bbox="909 1809 1173 1843">(5) Pulse voltage (B)</th> <td></td> </tr> <tr> <td data-bbox="446 1843 646 2060">Positional Measurement (Rated voltage)</td> <td data-bbox="646 1843 909 2060">  </td> <td data-bbox="909 1843 1173 2060">  </td> <td></td> </tr> </tbody> </table>	Voltage	(1) DC voltage	(2) DC + AC voltage	(3) AC voltage	Positional Measurement (Rated voltage)				Voltage	(4) Pulse voltage (A)	(5) Pulse voltage (B)		Positional Measurement (Rated voltage)			
Voltage	(1) DC voltage	(2) DC + AC voltage	(3) AC voltage															
Positional Measurement (Rated voltage)																		
Voltage	(4) Pulse voltage (A)	(5) Pulse voltage (B)																
Positional Measurement (Rated voltage)																		

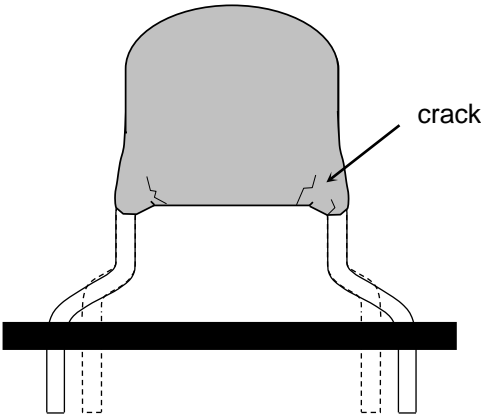
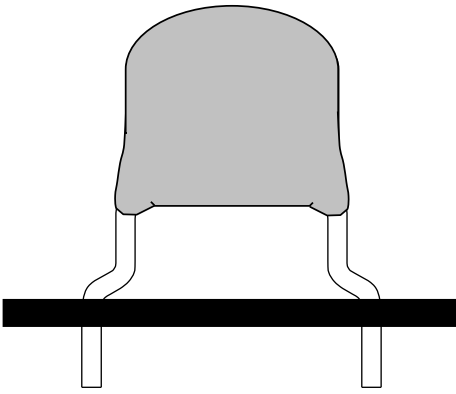
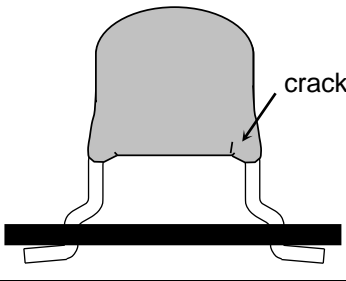
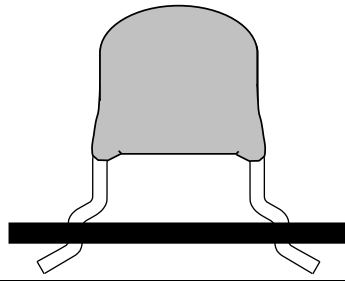
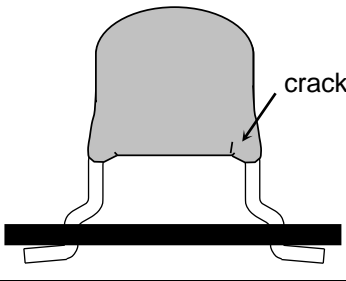
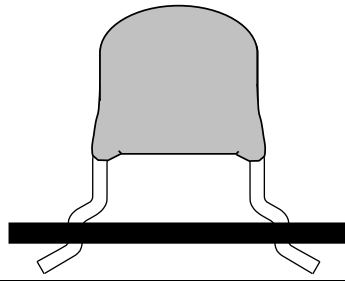
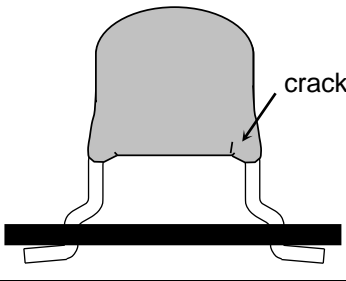
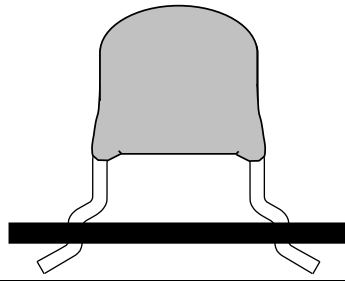
No.	Process	Condition						
2	Circuit design ⚠ Caution	<p>2) Even below the rated voltage, if repetitive high frequency AC or pulse is applied, the reliability of the capacitor may be reduced.</p> <p>3) The effective capacitance will vary depending on applied DC and AC voltages. The capacitors should be selected and designed in taking the voltages into consideration.</p> <p>2-3. Frequency</p> <p>1) When the capacitors (Class 2) are used in AC and/or pulse voltages, the capacitors may vibrate themselves and generate audible sound.</p>						
3	Designing P.C.board	<p>If capacitor leads are inserted into different pitch holes, it may induce excessive stress in the capacitor or outer resin to result in cracking, and it may degrade the quality. Recommend capacitor layout is as following.</p> <div style="display: flex; justify-content: space-around; align-items: center;"> <div style="text-align: center;"> <p>Not recommended</p>  </div> <div style="text-align: center;"> <p>Recommended</p>  </div> </div>						
4	Lead wire insertion	<p>1) If the leads clinching is too tight, the lead wire tend to be pulled excessively to cause lead wire breakage or cracking of the coating and quality degradation. Please adjust the clinching and provide sufficient preventive maintenance. Recommended capacitor layout is as following.</p> <table border="1" style="width: 100%; border-collapse: collapse;"> <thead> <tr> <th style="width: 30%;"></th> <th style="width: 35%; text-align: center;">Not recommended</th> <th style="width: 35%; text-align: center;">Recommended</th> </tr> </thead> <tbody> <tr> <td style="vertical-align: middle;">Clinching</td> <td style="text-align: center;">  </td> <td style="text-align: center;">  </td> </tr> </tbody> </table> <p>2) If capacitor leads are inserted into different pitch holes, it may induce excessive stress in the capacitor or outer resin to result in cracking, and it may degrade the quality. When the lead pitch does not fit with the through hole on the pc board, please adjust the lead pitch so that the capacitor body would not receive excessive force.</p>		Not recommended	Recommended	Clinching		
	Not recommended	Recommended						
Clinching								

No.	Process	Condition
-----	---------	-----------

5 Soldering

5-1. Flux selection
 Although highly-activated flux gives better solderability, substances which increase activity may also degrade the insulation of the capacitors. To avoid such degradation, it is recommended following.

- 1) It is recommended to use a mildly activated rosin flux (less than 0.1wt% chlorine). Do not use acidic flux is not recommended.
- 2) Excessive flux must be avoided. Please provide proper amount of flux.
- 3) When water-soluble flux is used, enough washing is necessary.

5-2. Recommended soldering profile by various methods

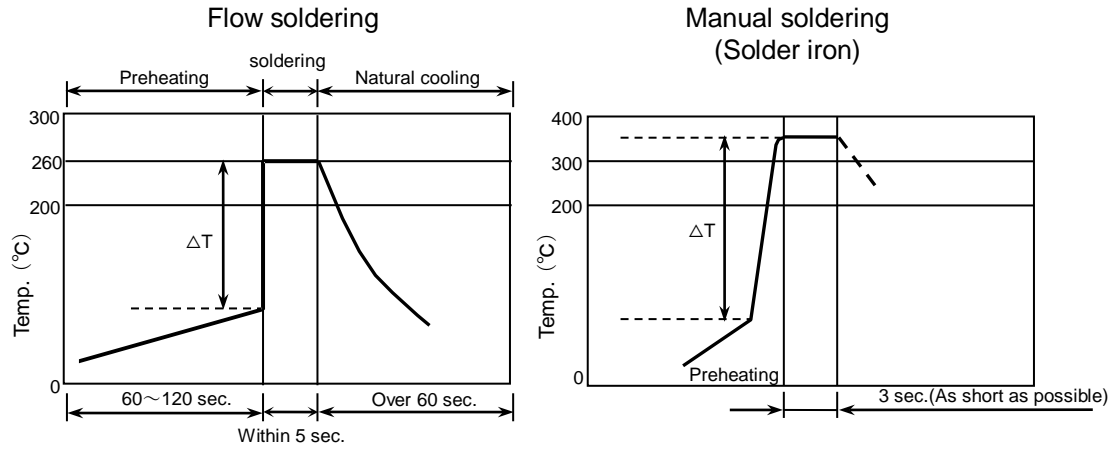

5-3. Avoiding thermal shock

1) Preheating condition

Soldering	Temp.(°C)
Wave soldering	$\Delta T \leq 150$
Manual soldering	$\Delta T \leq 190$

2) Cooling condition

Natural cooling using air is recommended. If the chips are dipped into a solvent for cleaning, the temperature difference(ΔT) must be less than 100°C.

5-4. Amount of solder

In sufficient solder may detach the capacitor from the P.C.board. See below for example of solder amount.

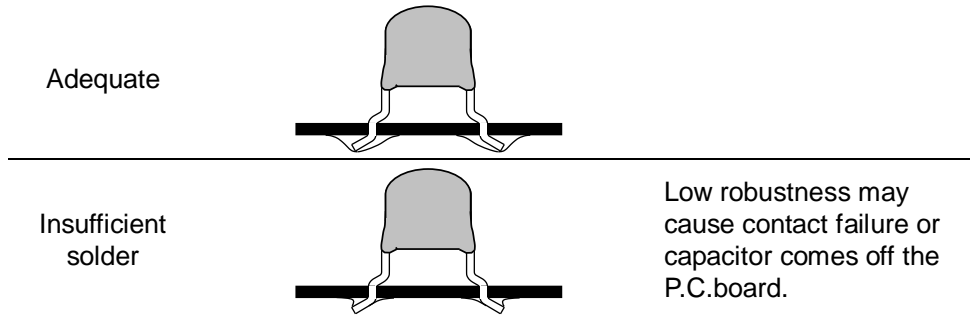

No.	Process	Condition								
5	Soldering	<p>5-5. Solder repair by solder iron Tip temperature of solder iron varies by its type, P.C.board material and solder land size. Higher the tip temperature, quick the operation is, but the heat shock may crack the capacitor. Following condition is recommended.</p> <p style="text-align: center;">(Recommended solder iron condition)</p> <table border="1" data-bbox="464 371 1362 472"> <thead> <tr> <th data-bbox="464 371 687 414">Temp. (°C)</th> <th data-bbox="687 371 911 414">Wattage (W)</th> <th data-bbox="911 371 1134 414">Shape (mm)</th> <th data-bbox="1134 371 1362 414">Time (sec.)</th> </tr> </thead> <tbody> <tr> <td data-bbox="464 414 687 472">350 MAX.</td> <td data-bbox="687 414 911 472">20 MAX.</td> <td data-bbox="911 414 1134 472">φ3.0 MAX.</td> <td data-bbox="1134 414 1362 472">3 MAX.</td> </tr> </tbody> </table>	Temp. (°C)	Wattage (W)	Shape (mm)	Time (sec.)	350 MAX.	20 MAX.	φ3.0 MAX.	3 MAX.
Temp. (°C)	Wattage (W)	Shape (mm)	Time (sec.)							
350 MAX.	20 MAX.	φ3.0 MAX.	3 MAX.							
6	Cleaning	<p>1) If an unsuitable cleaning fluid is used, flux residue or some foreign articles may stick to capacitor surface to deteriorate especially the insulation resistance.</p> <p>2) If cleaning condition is not suitable, it may damage the capacitor.</p> <p>2)-1. Insufficient washing (1) Terminal electrodes may corrode by Halogen in the flux. (2) Halogen in the flux may adhere on the surface of capacitor, and lower the insulation resistance. (3) Water soluble flux has higher tendency to have above mentioned problems (1) and (2).</p> <p>2)-2. Excessive washing (1) Excessive washing way damage the coating material of coated capacitor and deteriorate it. (2) When ultrasonic cleaning is used, excessively high ultrasonic energy output can affect the adhesion between the ceramic dielectric and the terminal electrodes. To avoid this, following is the recommended condition.</p> <p style="text-align: center;">Power : 20W/l max. Frequency : 40kHz max. Washing time : 5 minutes max.</p> <p>2)-3. If the cleaning fluid is contaminated, density of Halogen increases, and it may bring the same result as insufficient cleaning.</p>								
7	Coating and molding of the P.C.board	<p>1) When the P.C.board is coated, please verify the quality influence on the product.</p> <p>2) Please verify carefully that there is no harmful decomposing or reaction gas emission during curing which may damage the capacitor.</p> <p>3) Please verify the curing temperature.</p>								

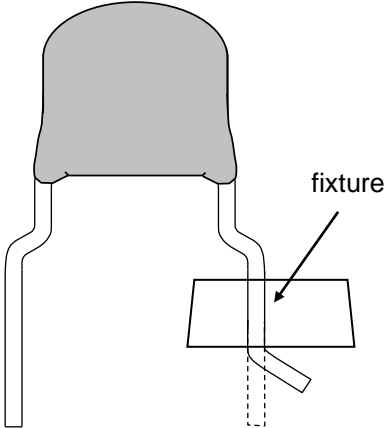
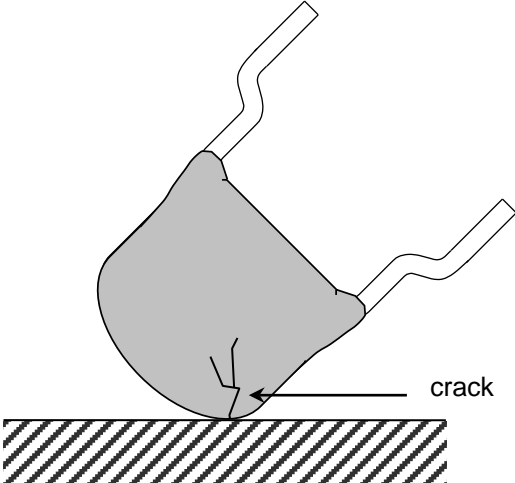
No.	Process	Condition
8	Lead wire bending	<p data-bbox="443 197 1469 286">During lead wire bending process, mechanical stress often concentrates in one part of capacitor body and it may damage the ceramic and the coating. Refer to following for bending the lead wire.</p> <div data-bbox="742 302 1129 728" style="text-align: center;">  </div> <p data-bbox="443 768 1469 835">When bending the lead wire, hold the wire closer to the capacitor with a fixture so that the lead bending would not affect the capacitor body.</p>
9	Handling of loose capacitor	<p data-bbox="443 869 1469 958">If dropped the capacitor may crack. Once dropped do not use it. Especially, the large case sized capacitor is tendency to have cracks easily, so please handle with care.</p> <div data-bbox="699 936 1216 1417" style="text-align: center;">  </div>
10	Capacitance aging	<p data-bbox="443 1473 1469 1574">The capacitors (Class 2) have aging in the capacitance. They may not be used in precision time constant circuit. In case of the time constant circuit, the evaluation should be done well.</p>
11	Estimated life and estimated failure rate of capacitors	<p data-bbox="443 1608 1469 1798">The estimated life and the estimated failure rate depend on the temperature and the voltage. This can be calculated by the equation described in JEITA RCR-2335C Annex F(Informative) Calculation of the estimated lifetime and the estimated failure rate (Temperature acceleration : 3rd powered low, Voltage acceleration : 10degC law) The failure rate can be decreased by reducing the temperature and the voltage but they will not be guaranteed.</p>

No.	Process	Condition
12	Caution during operation of equipment	<p>1) A capacitor shall not be touched directly with bare hands during operation in order to avoid electric shock. Electric energy held by the capacitor may be discharged through the human body when touched with a bare hand. Even when the equipment is off, a capacitor may stay charged. The capacitor should be handled after being completely discharged using a resistor.</p> <p>2) The terminals of a capacitor shall not be short-circuited by any accidental contact with a conductive object. A capacitor shall not be exposed to a conductive liquid such as an acid or alkali solution. A conductive object or liquid, such as acid and alkali, between the terminals may lead to the breakdown of a capacitor due to short circuit</p> <p>3) Confirm that the environment to which the equipment will be exposed during transportation and operation meets the specified conditions. Do not to use the equipment in the following environments.</p> <p>(1) Environment where a capacitor is spattered with water or oil (2) Environment where a capacitor is exposed to direct sunlight (3) Environment where a capacitor is exposed to Ozone, ultraviolet rays or radiation (4) Environment where a capacitor exposed to corrosive gas(e.g. hydrogen sulfide, sulfur dioxide, chlorine. ammonia gas etc.) (5) Environment where a capacitor exposed to vibration or mechanical shock exceeding the specified limits. (6) Atmosphere change with causes condensation</p>
13	Others  Caution	<p>The product listed in this specification is intended for use in automotive applications under normal operation and usage conditions.</p> <p>The product is not designed or warranted to meet the requirements of the applications listed below, whose performance and/or quality requires a more stringent level of safety or reliability, or whose failure, malfunction or defect could cause serious damage to society, person or property. Please understand that we are not responsible for any damage or liability caused by use of the products in any of the applications below or for any other use exceeding the range or conditions set forth in this specification sheet. If you intend to use the products in the applications listed below or if you have special requirements exceeding the range or conditions set forth in this specification, please contact us.</p> <p>(1) Aerospace/Aviation equipment (2) Transportation equipment (electric trains, ships etc.) (3) Medical equipment (Excepting Pharmaceutical Affairs Law classification Class1,2) (4) Power-generation control equipment (5) Atomic energy-related equipment (6) Seabed equipment (7) Transportation control equipment (8) Public information-processing equipment (9) Military equipment (10) Electric heating apparatus, burning equipment (11) Disaster prevention/crime prevention equipment (12) Safety equipment (13) Other applications that are not considered general-purpose applications</p> <p>When designing your equipment even for general-purpose applications, you are kindly requested to take into consideration securing protection circuit/device or providing backup circuits in your equipment.</p> <p>In addition, although the product listed in this specification is intended for use in automotive applications as described above, it is not prohibited to use in general electronic equipment, whose performance and/or quality doesn't require a more stringent level of safety or reliability, or whose failure, malfunction or defect could not cause serious damage to society, person or property.</p> <p>Therefore, the description of this caution will be applied, when the products are used in general electronic equipment under a normal operation and usage conditions.</p>

11.TAPE PACKAGING SPECIFICATION

1. DIMENSION OF TAPING

Dimensions of FA1* type shall be according to Appendix 2.
 Dimensions of FA2* type shall be according to Appendix 3.

2. QUANTITY

Type	Parts quantity/box (pcs.)
FA18, FA28 FA14, FA24 FA16, FA26	2,000
FA11, FA20	1,500
FA22, FA23	1,000

3. PERFORMANCE SPECIFICATIONS

- 3-1. The missing of components shall be within consecutive 3pcs.
- 3-2. Empty part for min 3pcs shall be provided at the beginning and the end of taping.
- 3-3. Shipping label must be attached at the side of carton.
- 3-4. When pull the carrier tape for left side with keeping the head of capacitors to the direction of the above figure, adhesive tape shall be upper side.
- 3-5. Folded tape shall contain 25pcs. of components.

4. PACKAGING SPECIFICATION (Ammo pack)

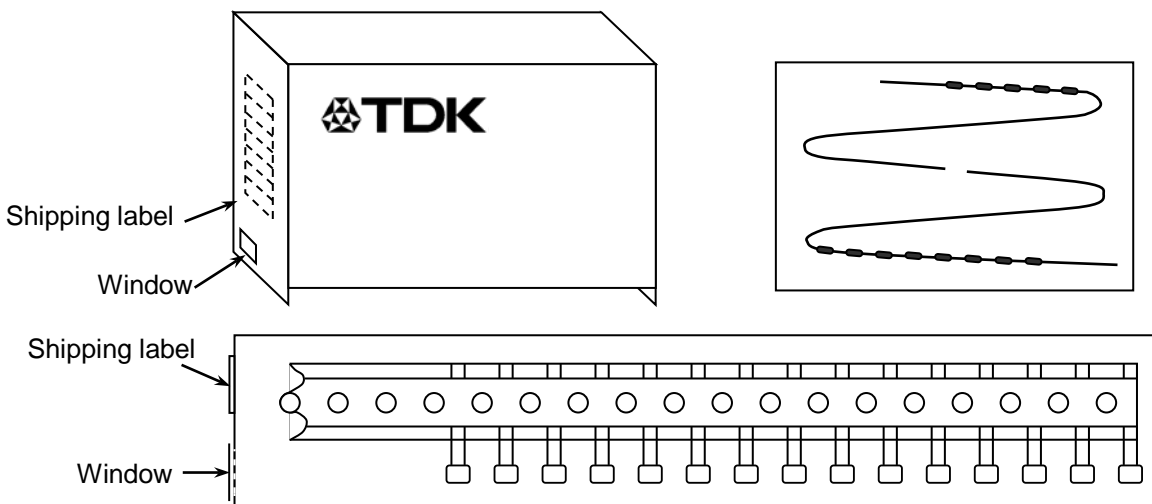

- 4-1. Head of the capacitors shall face the window.
- 4-2. In case of FA22 and FA23 series, a stainless round steel is put in a hole of tape. Please remove a stainless round steel at the time of use.

Appendix 2

Taping dimensions

(FA18,FA14,FA16,FA11)

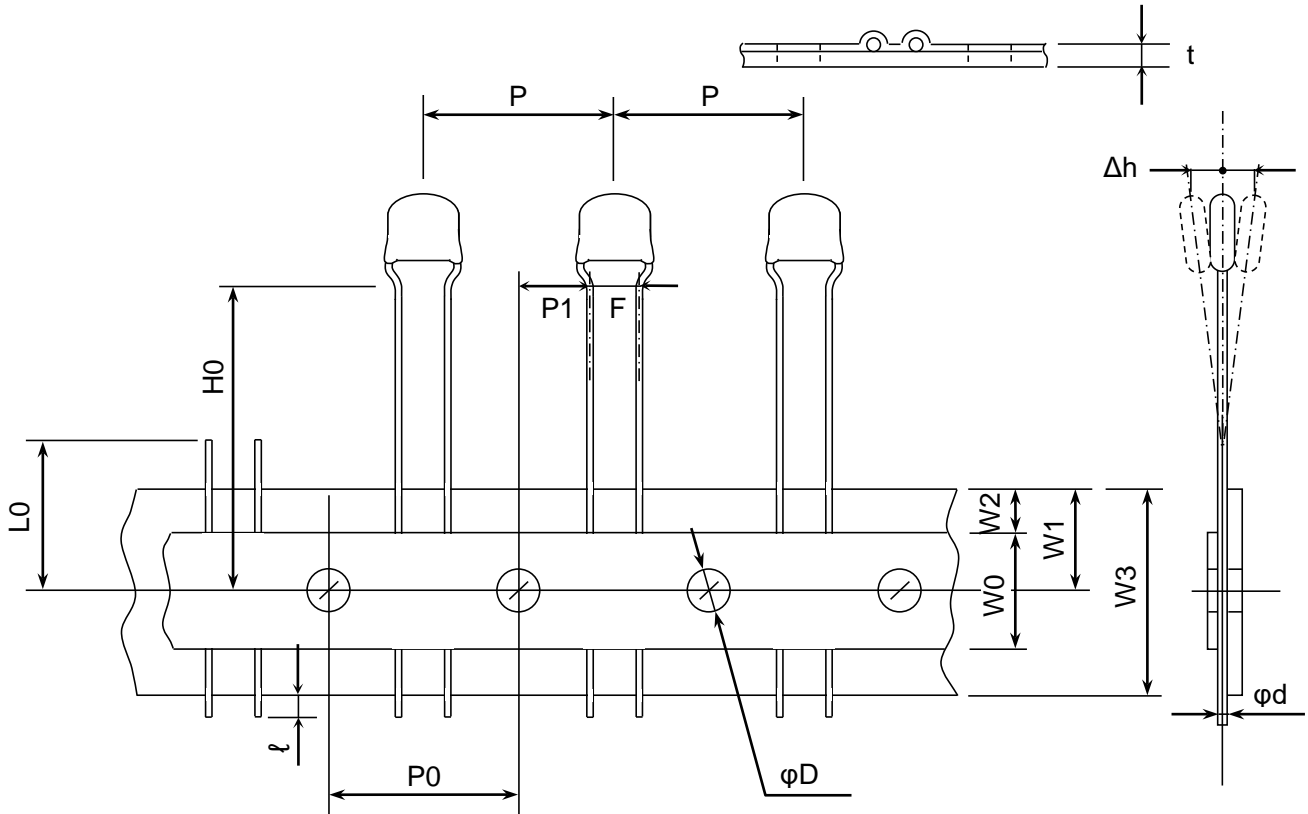

(Unit : mm)

Symbol	Dimensions	Note
P	(12.7)	
P0	(12.7)	
P1	(5.1)	
W0	12.0±1.0	
W1	9.0±0.5	
W2	3.0 max.	Adhesive tape shall not stick out from carrier tape.
W3	18.0+1.0,-0.5	
H0	16.0±0.8	
ℓ	1.0 max.	
t	0.6±0.2	
L0	11.0 max.	
F	2.5+0.5,-0.2	The measurement point is 1.5 to 2.0mm below the kink.
φd	φ0.5+0.1,-0.03	
φD	(φ4.0)	
Δh	(±2)	

() Reference value.

Appendix 3

Taping dimensions (FA28,FA24,FA26,FA20,FA22,FA23)

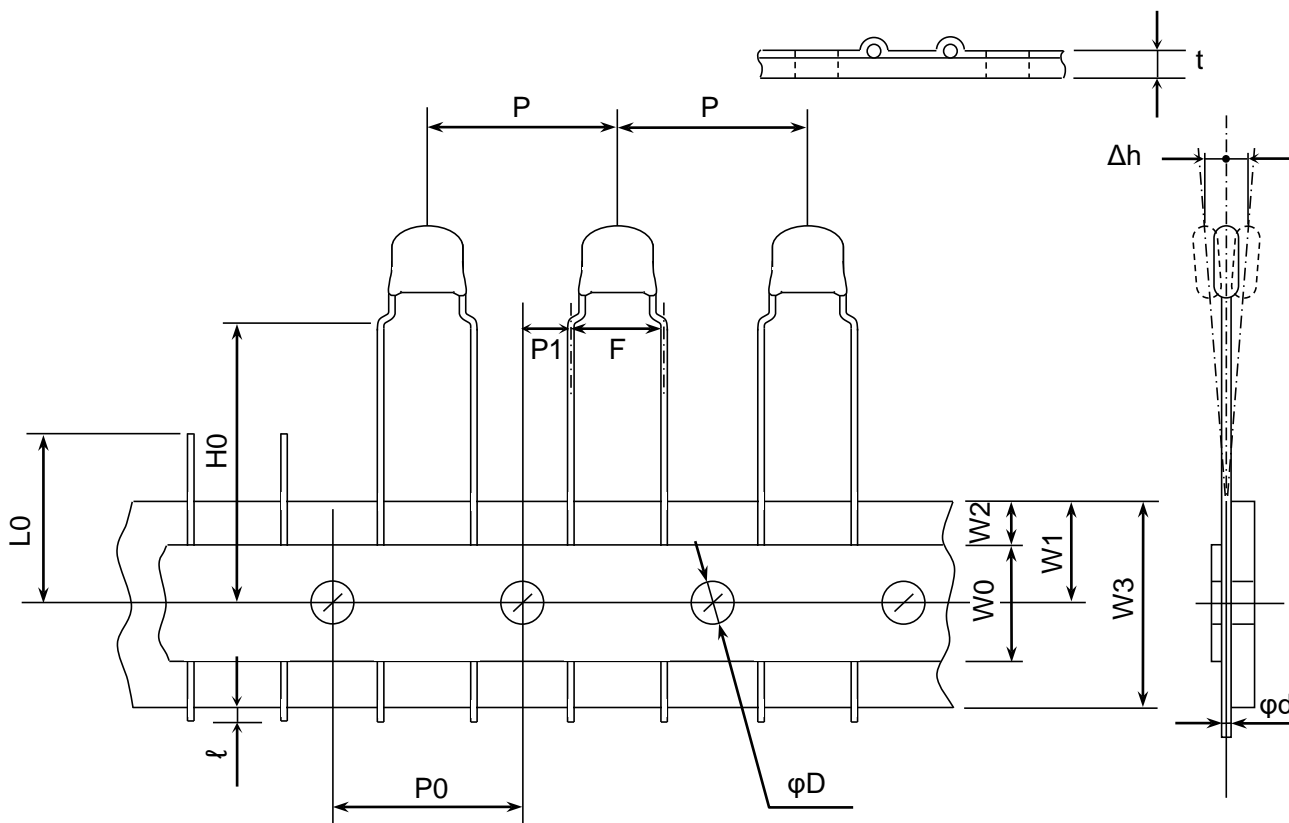

(Unit : mm)

Symbol	Dimensions	Note
P	(12.7)	
P0	(12.7)	
P1	(3.85)	
W0	12.0±1.0	
W1	9.0±0.5	
W2	3.0 max.	Adhesive tape shall not stick out from carrier tape.
W3	18.0+1.0,-0.5	
H0	16.0±0.8	
l	1.0 max.	
t	0.6±0.2	
L0	11.0 max.	
F	5.0+0.8,-0.2	The measurement point is 1.5 to 2.0mm below the kink.
φd	φ0.5+0.1,-0.03	
φD	(φ4.0)	
Δh	(±2)	

() Reference value.