



ULTRA LOW NOISE, HIGH IP3

Monolithic Amplifier PMA2-252LN+

50Ω 1.5 to 2.5 GHz

THE BIG DEAL

- Low Noise figure, 0.8 dB at 1.8 GHz
- High IP3, 30 dBm typ. at 1.8 GHz
- Adjustable Current, 25 to 80 mA
- P1dB 17.9 dBm typ. at 1.8 GHz
- Adjustable Gain, ±1.5 dB
- Active Bias
- May be used as a replacement for MGA-632P8^{a,b}

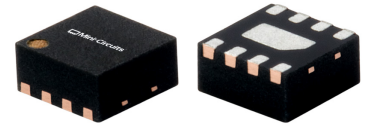

Generic photo used for illustration purposes only

CASE STYLE: MC1631

+RoHS Compliant

The +Suffix identifies RoHS Compliance. See our web site for RoHS Compliance methodologies and qualifications

APPLICATIONS

- Base station infrastructure
- Satellite Communication (Inmarsat)
- LTE
- GPS
- Tactical Air Navigation

PRODUCT OVERVIEW

Mini-Circuits PMA2-252LN+ is a E-PHEMT based Ultra-Low Noise MMIC Amplifier with a unique combinations of low noise and high IP3 making this amplifier ideal for sensitive high dynamic range receiver applications. This design operates on a single 3 to 4V supply.

KEY FEATURES

Feature	Advantages
Ultra Low Noise, 0.8 dB at 1.8 GHz	Excellent noise figure performance. Increases signal to noise ratio.
High IP3, +30 dBm at 1.8 GHz	Combining Low Noise and High IP3 makes this MMIC amplifier ideal for use in Low Noise Receiver Front End (RFE) as it gives the user advantages at both ends of the dynamic range: sensitivity & two-tone IM performance.
Adjustable Current	Provides users ability to set current consumption over a wide range from 25 to 80 mA.
2mm x 2mm 8 lead MCLP Package	Low Inductance, repeatable transitions, excellent thermal contact to PCB
Max Input Power, +27 dBm	Ruggedized design operates up to high input powers often seen at Receiver inputs eliminating the need for an external limiter.
High Reliability	Low, small signal operating current of 57 mA nominal maintains junction temperatures typically below 100°C at 85°C ground lead temperature.

A. Suitability for model replacement within a particular system must be determined by and is solely the responsibility of the customer based on, among other things, electrical performance criteria, stimulus conditions, application, compatibility with other components and environmental conditions and stresses.

B. The Avago MGA-632P8 part number is used for identification and comparison purposes only





ULTRA LOW NOISE, HIGH IP3

Monolithic Amplifier PMA2-252LN+

ELECTRICAL SPECIFICATIONS⁽¹⁾ AT 25°C, UNLESS NOTED OTHERWISE

Parameter	Condition (GHz)	Vs=4V			Vs=3V	Units
		Min.	Typ.	Max.	Typ.	
Frequency Range		1.5		2.5		GHz
Noise Figure	1.5		0.7		0.7	dB
	1.8		0.8		0.8	
	2.0		0.8		0.9	
	2.2		0.8		1.1	
	2.5		1.2		1.1	
Gain	1.5	—	19.5	—	18.8	dB
	1.8	—	18.6	—	17.8	
	2.0	15.8	17.6	19.5	16.8	
	2.2	—	16.5	—	15.7	
	2.5	—	15.7	—	14.8	
Input Return Loss	1.5		21.3		17.5	dB
	1.8		19.9		15.4	
	2.0		18.0		14.4	
	2.2		16.3		13.4	
	2.5		14.9		13.0	
Output Return Loss	1.5		10.0		10.8	dB
	1.8		23.3		28.5	
	2.0		18.2		16.9	
	2.2		12.9		11.9	
	2.5		8.3		7.9	
Output Power @1 dB compression ⁽²⁾	1.5		18.5		16.2	dBm
	1.8		17.9		15.9	
	2.0		17.8		15.6	
	2.2		17.4		15.3	
	2.5		16.2		13.9	
Output IP3	1.5		31.1		27.1	dBm
	1.8		30.1		25.5	
	2.0		30.0		25.3	
	2.2		29.3		24.8	
	2.5		27.6		23.2	
Device Operating Voltage		3.8	4.0	4.2	3.0	V
Device Operating Current at typical voltage ⁽²⁾			57	70	41	mA
Device Current variation vs. Temperature at typical voltage ⁽³⁾			-19.0		-3.4	μA/°C
Device Current Variation vs Voltage			0.018		0.017	mA/mV
Thermal Resistance			53		53	°C/W

(1) Measured on Mini-Circuits Characterization test board TB-642+. See Characterization Test Circuit (Fig. 1) R1=825Ω, RBIAS=619Ω

(2) Current increases at P1dB

(3) (Current at 85°C - Current at -45°C)/130

MAXIMUM RATINGS

Parameter	Ratings
Operating Temperature (ground lead)	-40°C to 85°C
Storage Temperature	-65°C to 150°C
Junction Temperature	150°C
Total Power Dissipation	0.55W
Input Power (CW), Vs=3V or 4V	+25 dBm (5 minutes max), +20 dBm (continuous)
DC Voltage (Vs)	5.5 V

Permanent damage may occur if any of these limits are exceeded. Electrical maximum ratings are not intended for continuous normal operation.

DC CURRENT HISTOGRAM AT Vs=4V

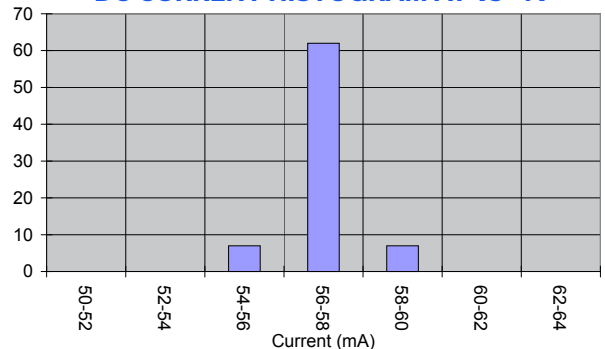



ULTRA LOW NOISE, HIGH IP3

Monolithic Amplifier PMA2-252LN+

SIMPLIFIED SCHEMATIC AND PAD DESCRIPTION

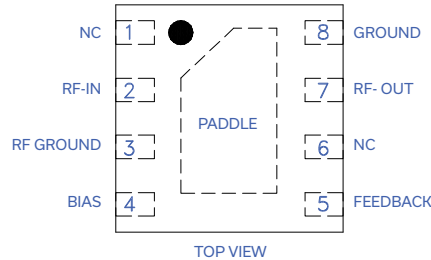
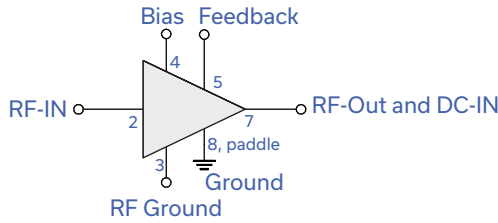

Function	Pad Number	Description (Ref: Figure1)
RF IN	2	Connects to RF input via C1 and Pad 3 via L1
RF-OUT	7	Connects to RF out via C2, Pad 5 via R1 and C3
RF-Ground	3	Connects to ground via C4 and Pad 2 via L1
Bias	4	Connects to Supply voltage (Vs) via Rbias
Feedback	5	Connected to pads via R1 and C3
No Connection	1,6	Not used internally. Pin 1 Connected to ground on test board
Ground	8 & paddle	Connects to ground

RECOMMENDED APPLICATION AND CHARACTERIZATION TEST CIRCUIT

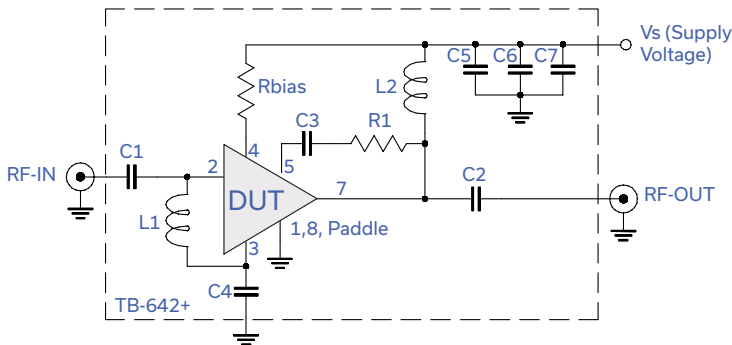
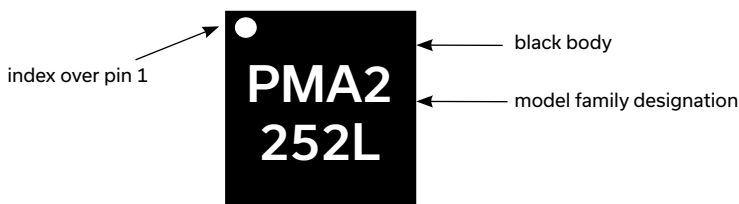

Fig 1. Application and Characterization Circuit
 Note: This block diagram is used for characterization. (DUT soldered on Mini-Circuits Characterization test board TB-642+)
 Gain, Return loss, Output power at 1dB compression (P1 dB), output IP3 (OIP3) and noise figure measured using Agilent's N5242A PNA-X microwave network analyzer.

- Conditions:
- Gain and Return loss: Pin= -25dBm
 - Output IP3 (OIP3): Two tones, spaced 1 MHz apart, 0 dBm/tone at output.

PRODUCT MARKING



Marking may contain other features or characters for internal lot control

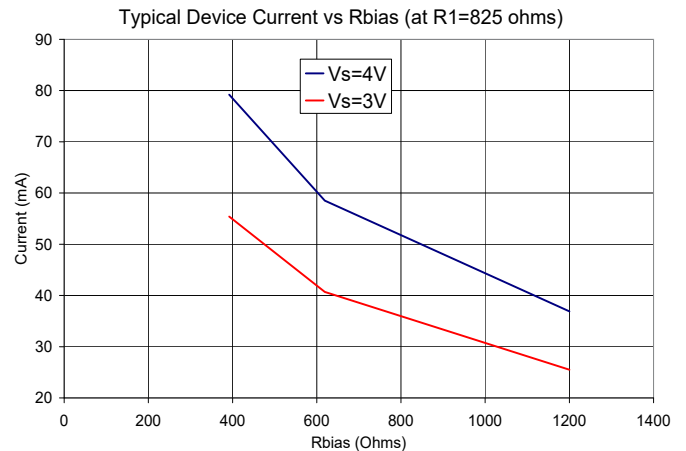



ULTRA LOW NOISE, HIGH IP3

Monolithic Amplifier PMA2-252LN+

Mini-Circuits

ADJUSTABLE GAIN PERFORMANCE (Vs. R1) AT Vs=4V

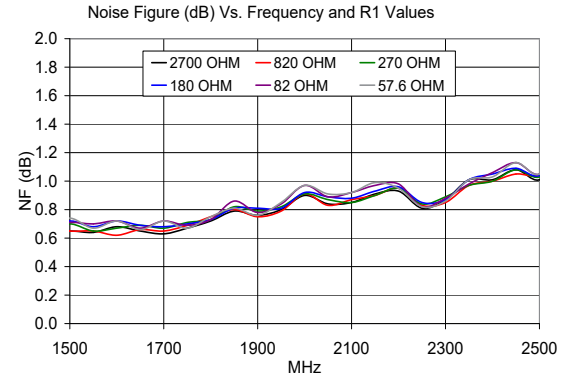
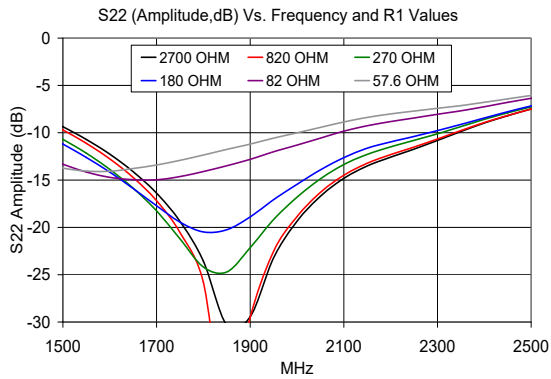
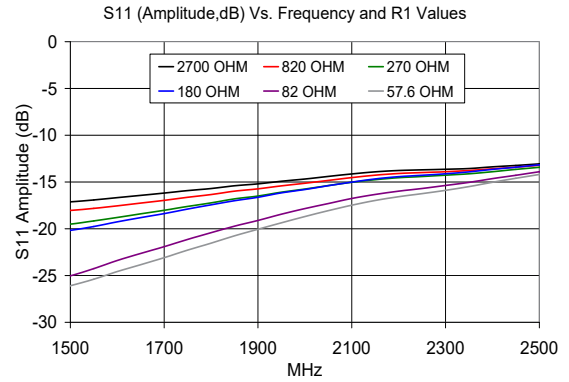
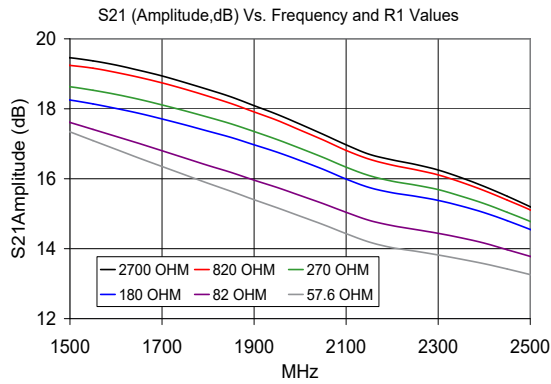

ADJUSTABLE GAIN PERFORMANCE (Vs. R1) AT Vs=3V

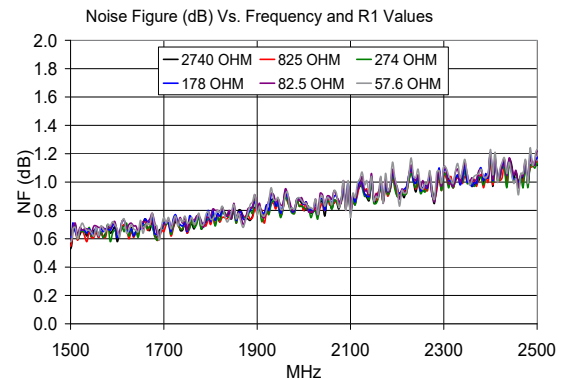
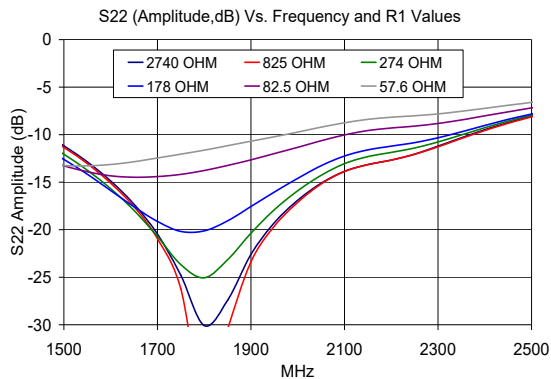
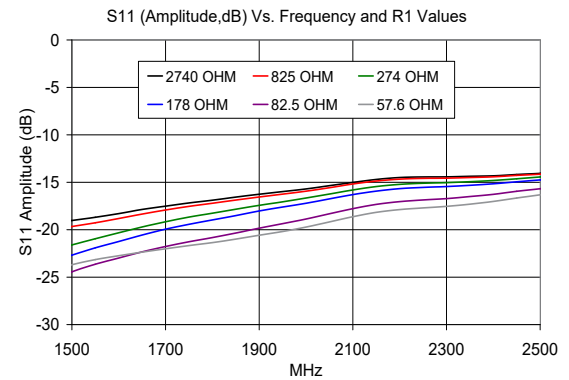
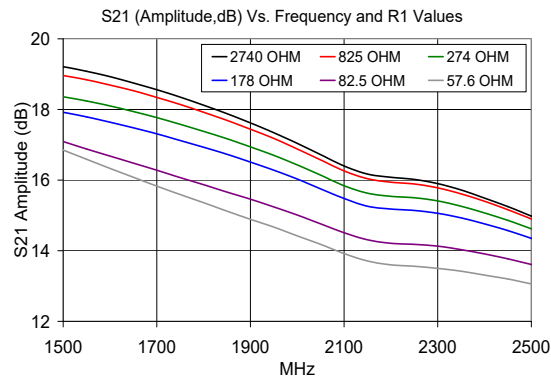



ULTRA LOW NOISE, HIGH IP3

Monolithic Amplifier PMA2-252LN+

Mini-Circuits

ADDITIONAL DETAILED TECHNICAL INFORMATION IS AVAILABLE ON OUR DASH BOARD. TO ACCESS [CLICK HERE](#)

Performance Data	Data Table
	Swept Graphs
	S-Parameter (S2P Files) Data Set (.zip file)
Case Style	MC1631 Plastic package, exposed paddle, lead finish: matte tin
Tape & Reel	F66
Standard quantities available on reel	7" reels with 20, 50, 100, 200, 500,1K,2K or 3K devices
Suggested Layout for PCB Design	PL-360
Evaluation Board	TB-642+
Environmental Ratings	ENV08T1

ESD RATING

Human Body Model (HBM): Class 1A (250 to <500V) in accordance with ANSI/ESD STM 5.1 - 2001

Machine Model (MM): Class M1 (pass 25V) in accordance with ANSI/ESD STM5.2-1999

MSL RATING

Moisture Sensitivity: MSL1 in accordance with IPC/JEDEC J-STD-020D

MSL TEST FLOW CHART

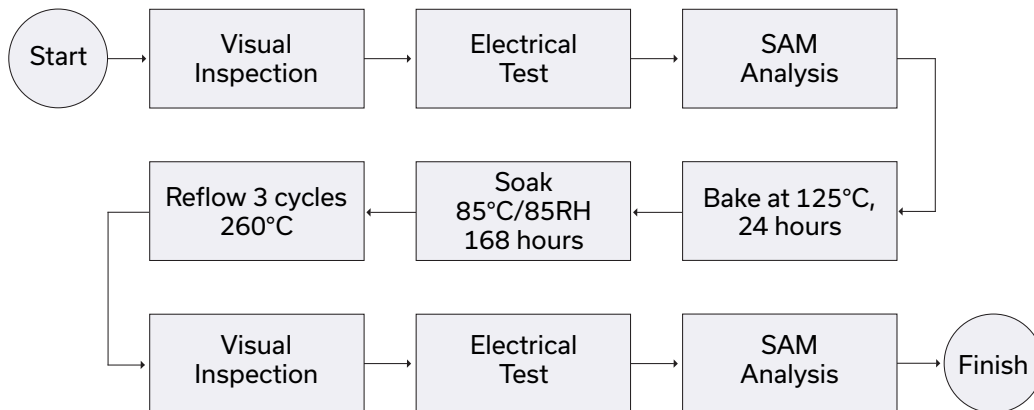

- NOTES**
- A. Performance and quality attributes and conditions not expressly stated in this specification document are intended to be excluded and do not form a part of this specification document.
 - B. Electrical specifications and performance data contained in this specification document are based on Mini-Circuit's applicable established test performance criteria and measurement instructions.
 - C. The parts covered by this specification document are subject to Mini-Circuits standard limited warranty and terms and conditions (collectively, "Standard Terms"); Purchasers of this part are entitled to the rights and benefits contained therein. For a full statement of the standard. Terms and the exclusive rights and remedies thereunder, please visit Mini-Circuits' website at www.minicircuits.com/MCLStore/terms.jsp

