

Device Features

- OIP3 = 40.0 dBm @ 70 MHz
- Gain = 27.1 dB @ 70 MHz
- Output P1 dB = 21.3 dBm @ 70 MHz
- Patented temperature compensation
- Patented over voltage protection
- RoHS2-compliant SOT-89 SMT package



Product Description

BeRex's BIF7 is a high performance InGaP/ GaAs HBT MMIC amplifier, internally matched to 50 Ohms and uses a patented **temperature compensation** circuit to provide stable current over the operating temperature range without the need for external components and a patented **over voltage protection** circuit to protect a internal device. The BIF7 is designed for high linearity IF amplifier that requires excellent gain, high OIP3 and flatness. It is packaged in a RoHS2-compliant with SOT-89 surface mount package.

Applications

- Base station Infrastructure/RFID
- Commercial/Industrial/Military wireless system

Applications Circuit

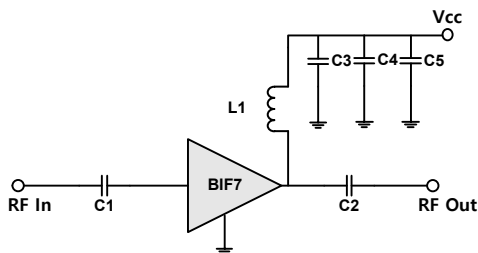

*C1, C2=100nF ± 5%; C3 = 100 pF ± 5%; C4 = 1000pF ±5%

*C5 = 10uF; L1 = 1uH ±5%

*C1, C2 = 100pF; L1 = 12nH ±5% for RF Bandwidth

Electrical Specifications

Device performance _ measured on a BeRex evaluation board at 25°C, Vc=5V, 50 Ω system.

Parameter	Conditions	Min	Typ	Max	Unit
Operational Frequency Range		5		800	MHz
Test Frequency			70		MHz
Gain		25.6	27.1		dB
Input Return Loss			-32.0		dB
Output Return Loss			-12.1		dB
Output IP3	10 dBm / tone , Δf=1 MHz	37.0	40.0		dBm
Output P1dB		20.3	21.3		dBm
Noise Figure			2.9		dB

Recommended Operating Conditions

Parameter	Min	Typ	Max	Unit
Bandwidth	5		800	MHz
I _c @ (V _c = 5V)	76	95	114	mA
V _c	4.5	5.0	5.25	V
dG/dT		-0.003		dB/°C
R _{TH}		50		°C/W
Operating Case Temperature	-40		+85	°C

Electrical specifications are measured at specified test conditions.

Specifications are not guaranteed over all recommended operating conditions.

Absolute Maximum Ratings

Parameter	Rating	Unit
Storage Temperature	-55 to +155	°C
Junction Temperature	+175	°C
Supply Voltage	+6.0	V
Supply Current	160	mA
Input RF Power	23	dBm

Operation of this device above any of these parameters may result in permanent damage.

Above 7V, a device goes to protection mode.

5-800 MHz Internally Matched IF Amplifier

Typical Performance (Vd = 5V, Ic = 95mA, T = 25°C)

Freq	MHz	70	140	250	500	800
S21	dB	27.1	27.0	26.7	25.7	25.0
S11	dB	-32.0	-41.1	-38.5	-28.6	-23.2
S22	dB	-12.1	-11.6	-10.1	-7.2	-6.5
P1	dBm	21.3	21.5	21.5	21.0	19.7
OIP3	dBm	40.0	38.5	38.0	36.0	32.5
NF	dB	2.9	2.9	3.0	3.0	3.0

Typical Performance (Vd = 4.7V, Ic = 78mA, T = 25°C)

Freq	MHz	70	140	250	500	800
S21	dB	26.7	26.6	26.4	25.7	24.6
S11	dB	-28.5	-32.5	-29.2	-23.3	-19.8
S22	dB	-10.9	-11.0	-10.4	-8.2	-6.0
P1	dBm	20.0	20.5	20.5	20.0	19.0
OIP3	dBm	35.5	35.5	35.0	33.0	31.5
NF	dB	2.9	2.9	3.0	3.0	3.0

Typical Performance (Vd = 4.5V, Ic = 67mA, T = 25°C)

Freq	MHz	70	140	250	500	800
S21	dB	26.7	26.6	26.2	25.1	24.5
S11	dB	-26.6	-28.2	-26.0	-21.6	-18.8
S22	dB	-10.5	-10.6	-10.1	-8.0	-5.8
P1	dBm	18.8	19.2	19.5	19.6	17.4
OIP3	dBm	34.5	34.0	33.0	31.5	33.0
NF	dB	2.9	2.9	3.0	3.0	3.0

V-I Characteristics

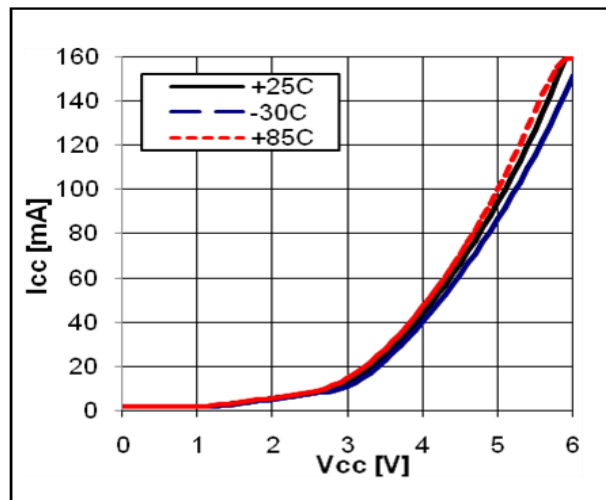

Typical Device Data

S-parameters (Vc=5V, Ic=95mA, T=25°C)

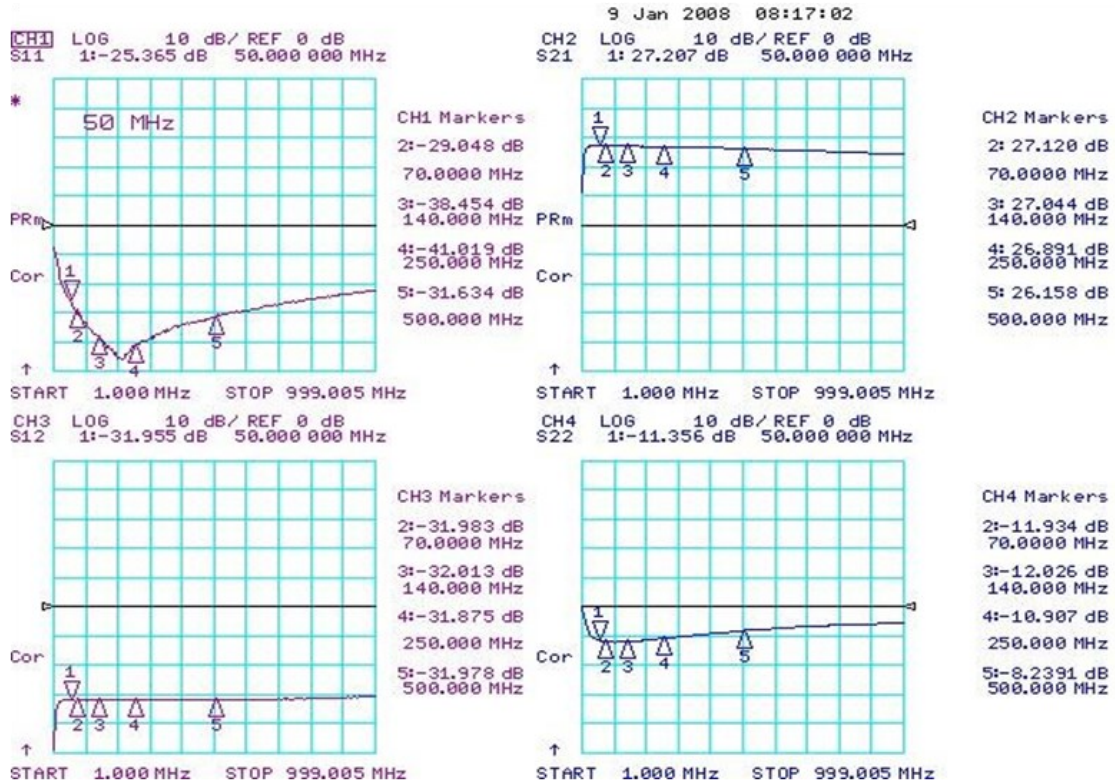

S-Parameter

(Vdevice = 5.0V, Icc = 95mA, T = 25 °C, calibrated to device leads)

Freq	S11	S11	S21	S21	S12	S12	S22	S22
[MHz]	[Mag]	[Ang]	[Mag]	[Ang]	[Mag]	[Ang]	[Mag]	[Ang]
100	0.590	175.3	25.200	170.9	0.027	2.7	0.242	-20.9
500	0.540	155.4	19.772	139.2	0.027	10.0	0.341	-92.7
1000	0.484	140.8	14.791	116.0	0.028	21.8	0.449	-148.9
1500	0.495	126.4	12.899	102.3	0.039	30.7	0.541	171.2
2000	0.443	114.8	10.915	76.4	0.044	26.5	0.568	139.2
2500	0.492	100.3	9.942	69.3	0.051	33.4	0.593	113.8
3000	0.473	82.1	10.121	41.0	0.062	22.0	0.609	89.9
3500	0.499	70.9	7.532	20.2	0.062	17.5	0.617	69.4
4000	0.558	52.8	6.114	4.8	0.072	6.5	0.617	42.1

RF Bandwidth

S-parameters (Vc=5V, Ic=95mA, T=25°C)

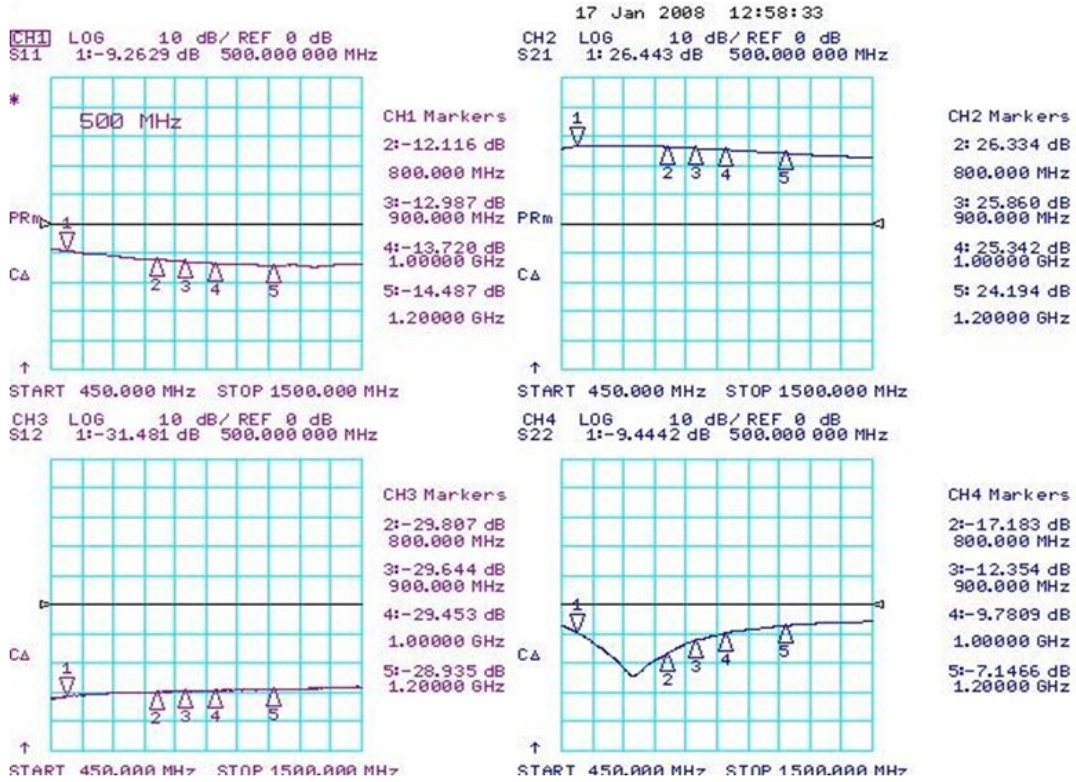

BeRex SOT89 Evaluation Board

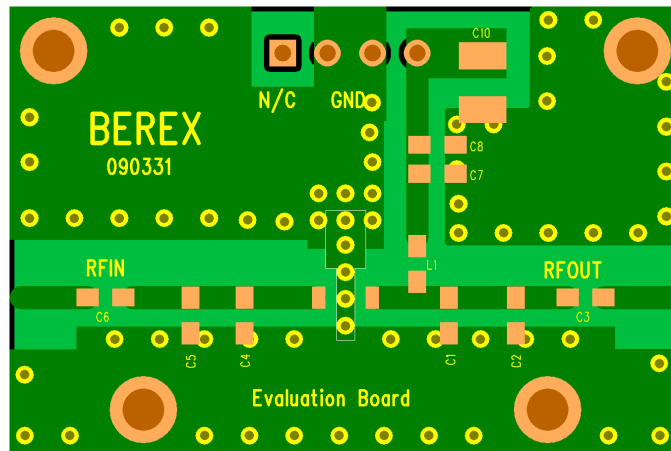

*Dielectric constant _ 4.2 *RF pattern width 52mil *31mil thick FR4 PCB

Typical Performance

($V_c=5V$, $I_c=95mA$, $T=25^\circ C$)

Pin-Pout-Gain

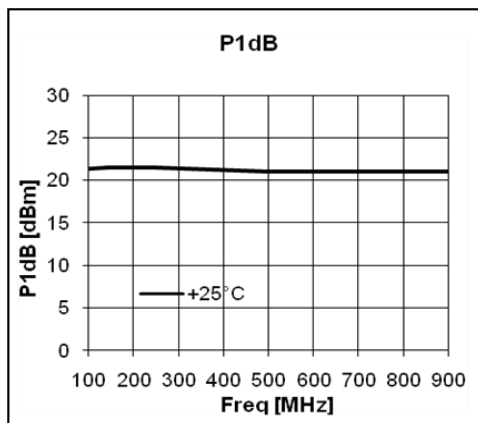
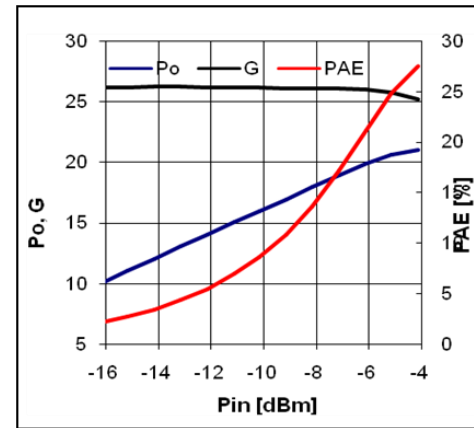
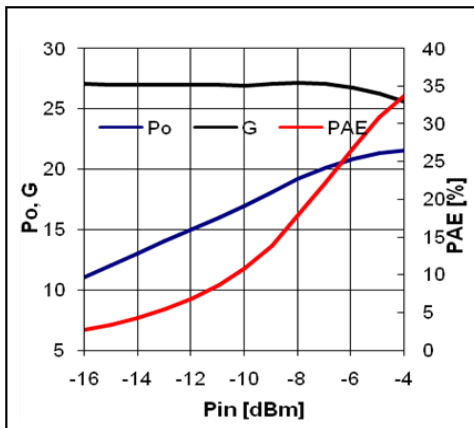
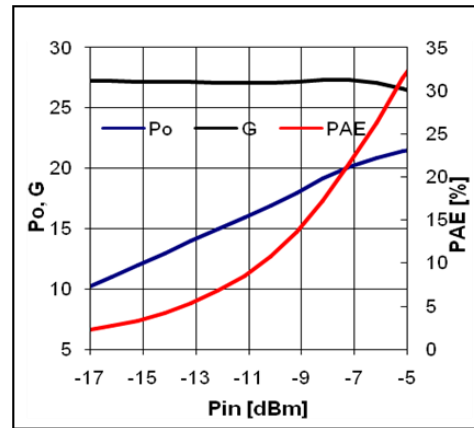
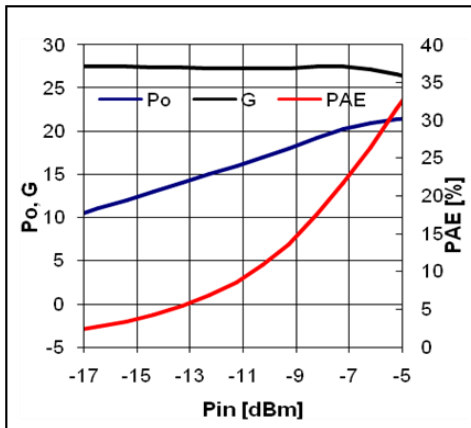

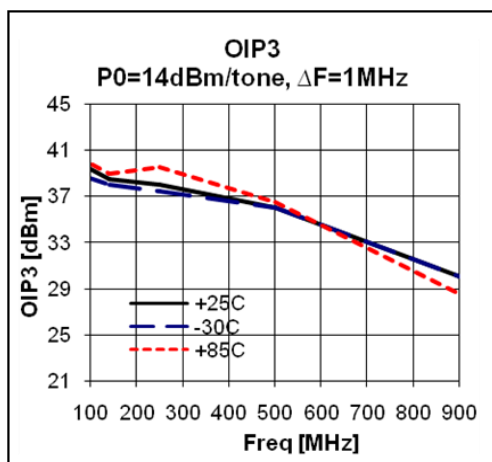
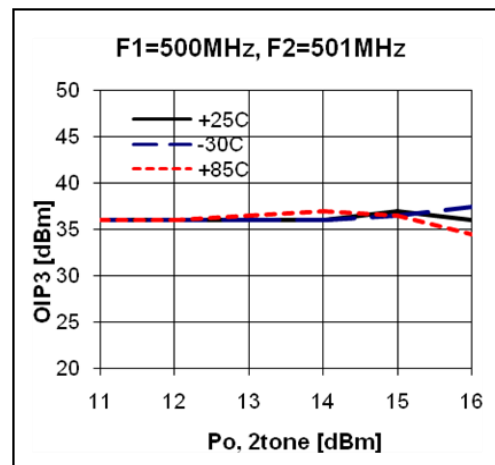
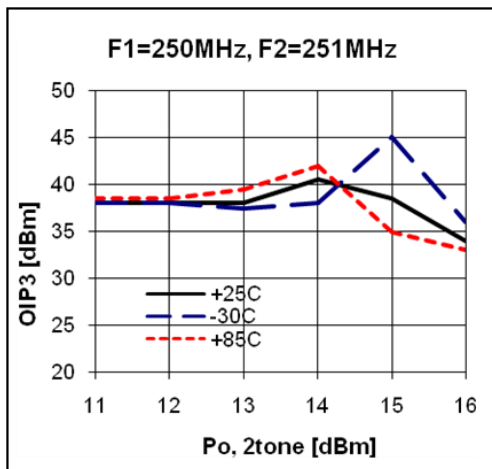
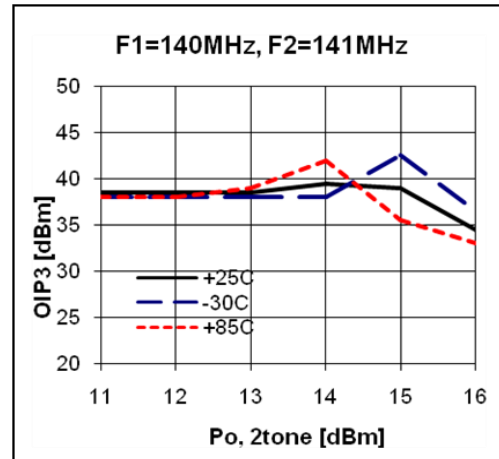
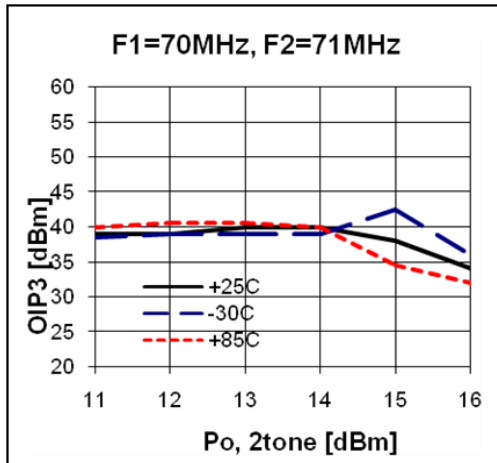
OIP3

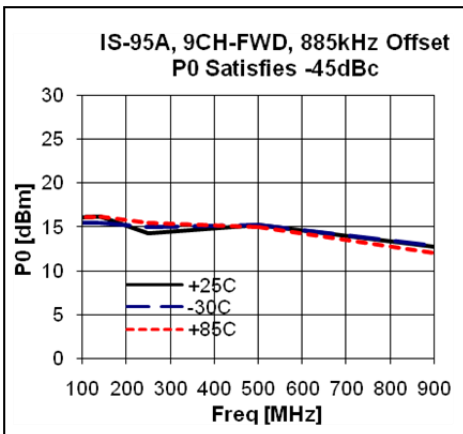
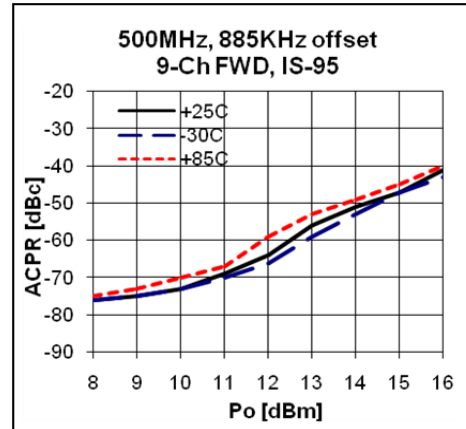
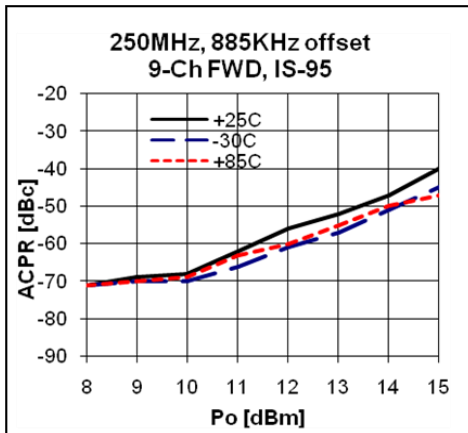
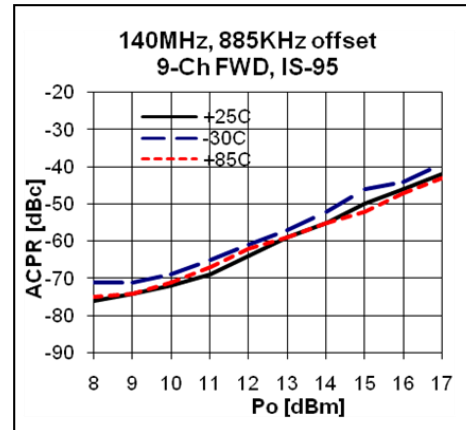
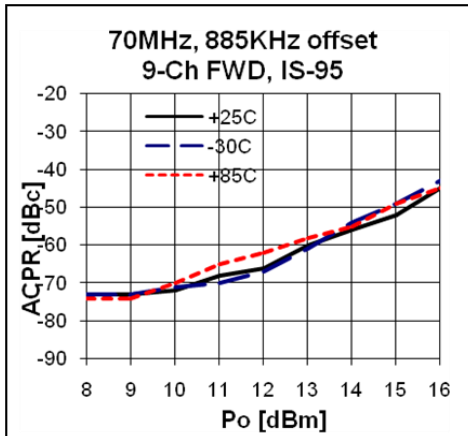
ACPR

ACLR

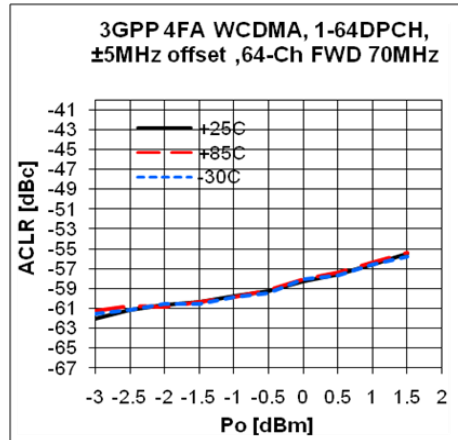

S-Parameters over Temperature

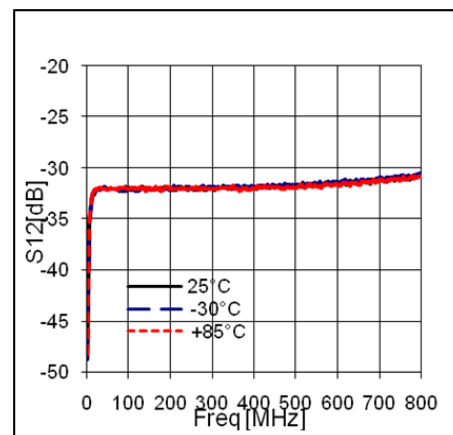
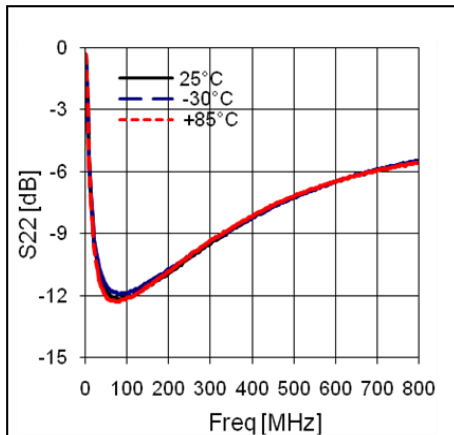
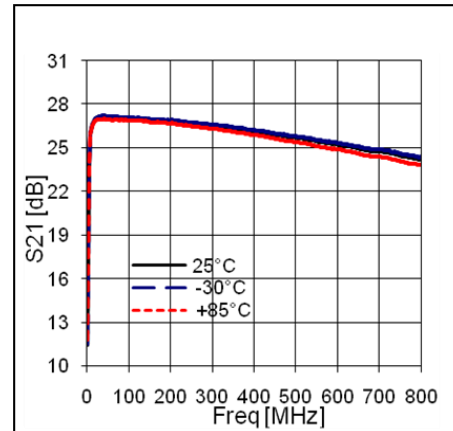
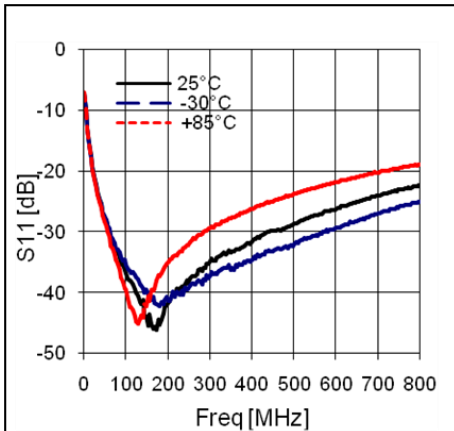

Package Outline Dimension

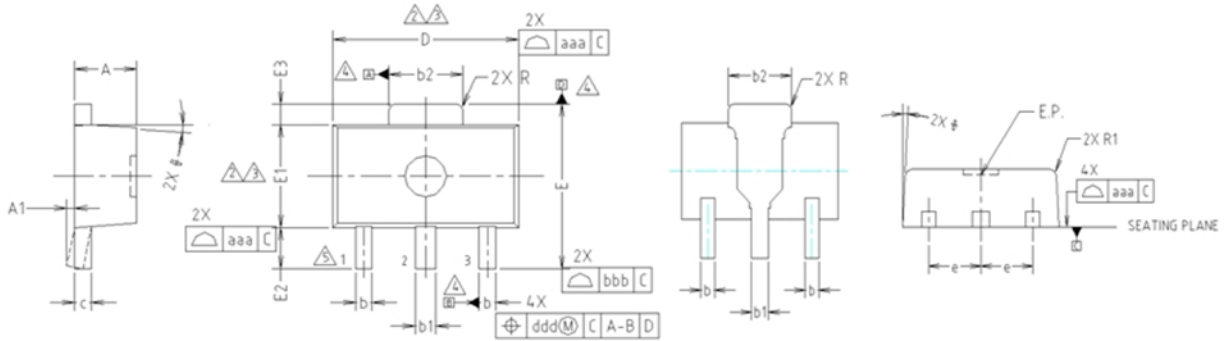

- NOTE:**
 1. DIMENSIONS IN MILLIMETERS.
- ⚠ DIMENSION D DOES NOT INCLUDE MOLD FLASH, PROTRUSIONS OR GATE BURRS. MOLD FLASH, PROTRUSIONS OR GATE BURRS SHALL NOT EXCEED 0.5mm PER END. DIMENSION E1 DOES NOT INCLUDE INTERLEAD FLASH OR PROTRUSION. INTERLEAD FLASH OR PROTRUSION SHALL NOT EXCEED 0.5mm PER SIDE.
 - ⚠ DIMENSIONS D AND E1 ARE DETERMINED AT THE OUTMOST EXTREMES OF THE PLASTIC BODY EXCLUSIVE OF MOLD FLASH, TIE BAR BURRS, GATE BURRS AND INTERLEAD FLASH, BUT INCLUDING ANY MISMATCH BETWEEN THE TOP AND BOTTOM OF THE PLASTIC BODY.
 - ⚠ DATUMS A, B AND D TO BE DETERMINED 0.18mm FROM THE LEAD TIP.
 - ⚠ TERMINAL NUMBERS ARE SHOWN FOR REFERENCE ONLY.

SYMBOL	MILLIMETERS			NOTE
	MINIMUM	NOMINAL	MAXIMUM	
A	1.40	1.50	1.60	
A1	0.00	—	0.10	
b	0.38	0.42	0.48	
b1	0.48	0.52	0.58	
b2	1.79	1.82	1.87	
c	0.40	0.42	0.46	
D	4.40	4.50	4.70	2,3
E	3.70	4.00	4.30	
E1	2.40	2.50	2.70	2,3
E2	0.80	1.00	1.20	
E3	0.40	0.50	0.60	
e	1.50 TYP.			
φ	4° TYP.			
R	0.15 TYP.			
R1	—	—	0.20	
SYMBOL	TOLERANCES OF FORM AND POSITION		NOTE	
aaa	0.15			
bbb	0.20			
ccc	0.10			
ddd	0.10			

Suggested PCB Land Pattern and PAD Layout

PCB Land Pattern

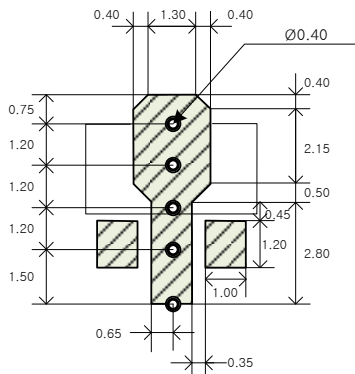

Note : All dimension _ millimeters

PCB lay out _ on BeRex website

PCB Mounting

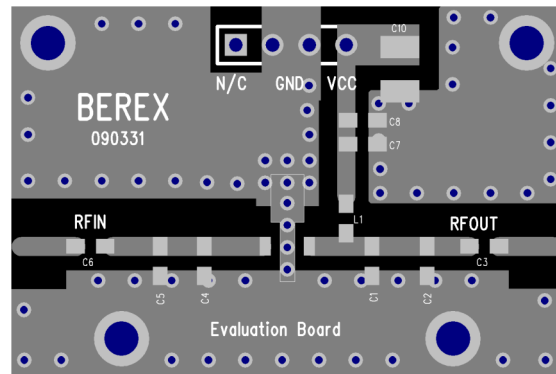

Package Marking

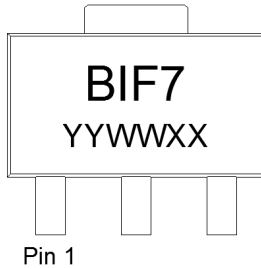

YY = Year, WW = Working Week,
XX = Wafer No.

Tape & Reel

SOT89

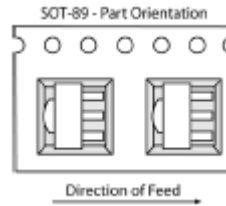

Packaging information:

Tape Width (mm): 12
Reel Size (inches): 7
Device Cavity Pitch (mm): 8
Devices Per Reel: 1000

Lead plating finish

100% Tin Matte finish

(All BeRex products undergoes a 1 hour, 150 degree C, Anneal bake to eliminate thin whisker growth concerns.)

MSL / ESD Rating

ESD Rating:	Class 1C
Value:	Passes <2000V
Test:	Human Body Model (HBM)
Standard:	JEDEC Standard JESD22-A114
MSL Rating:	Level 1 at +260°C convection reflow
Standard:	JEDEC Standard J-STD-020



Proper ESD procedures should be followed when handling this device.

RoHS Compliance

This part is compliant with Restrictions on the Use of Certain Hazardous Substances in Electrical and Electronic Equipment (RoHS) Directive 2011/65/EU as amended by Directive 2015/863/EU.

This product also is compliant with a concentration of the Substances of Very High Concern (SVHC) candidate list which are contained in a quantity of less than 0.1%(w/w) in each components of a product and/or its packaging placed on the European Community market by the BeRex and Suppliers.

NATO CAGE code:

2	N	9	6	F
---	---	---	---	---