

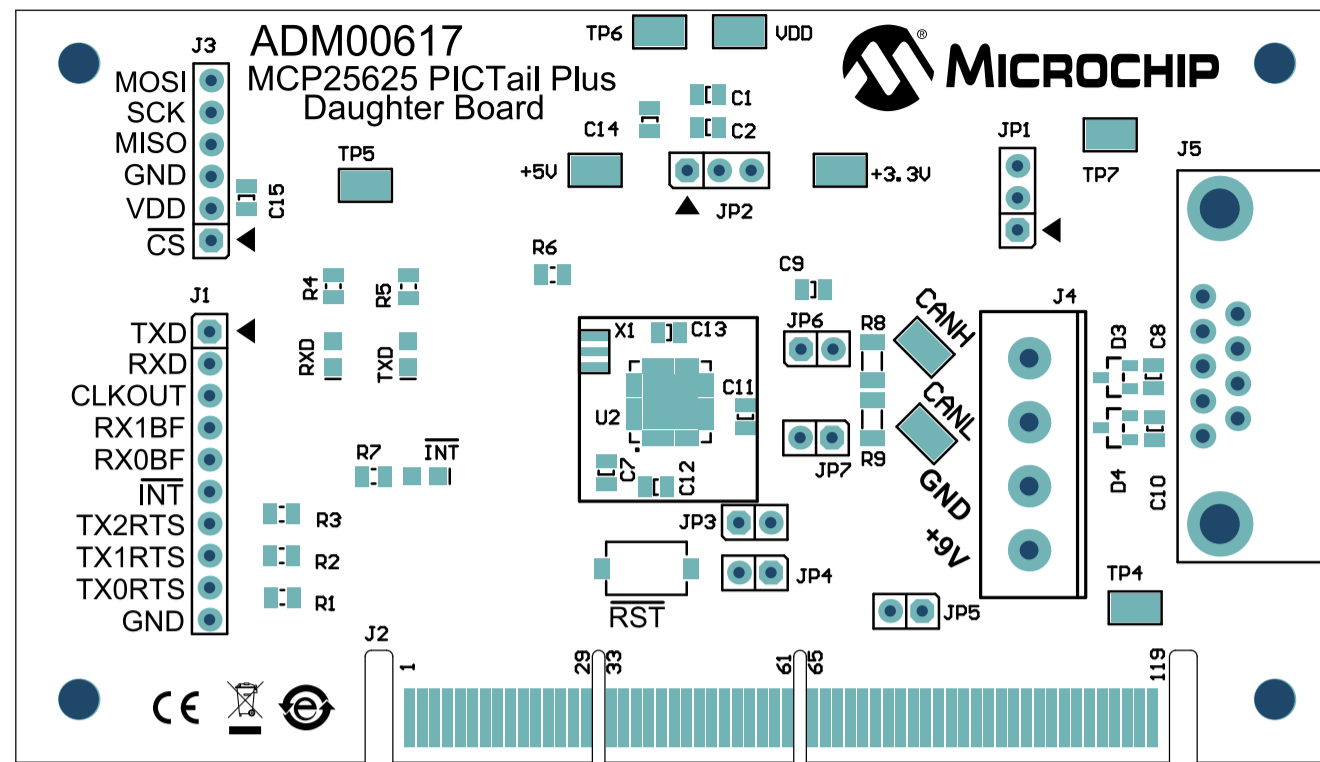



REV	ECO	Comments	Date

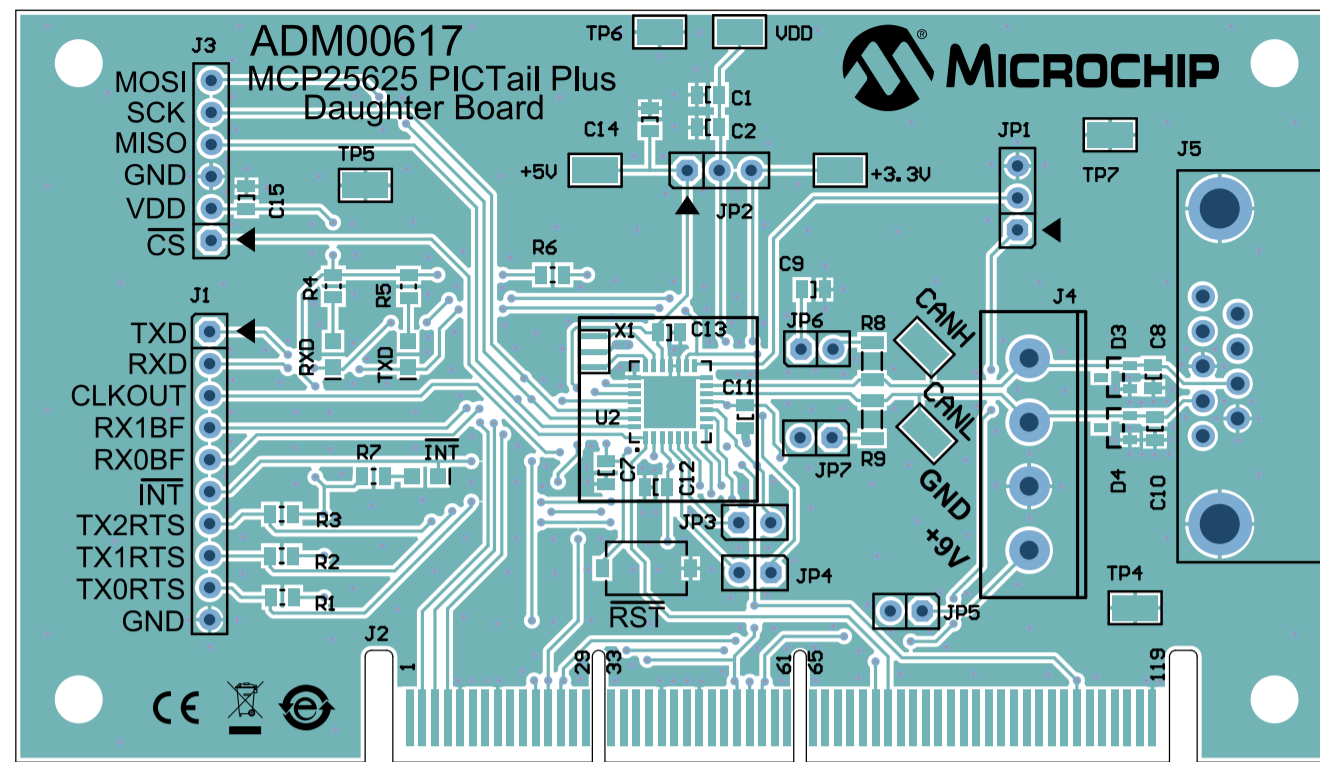

 MICROCHIP Microchip Technology Inc. 2355 W. Chandler Blvd. Chandler, AZ 85224	TITLE: MCP25625 PICTail Plus		PROJECT PART NUMBER: ADM00617
	PCB DESIGNER: Fernando Gonzalez	GERBER FILE: TOP Silk	
	ENGINEER: Fernando Gonzalez	BOARD NUMBER: 04-10350	DATE: 10/21/2015
	PCB FILE NAME: MCP25625 PICTail Plus.PcbDoc	LAYER NAME: BOARD (14)	REV: 1

REV	ECO	Comments	Date

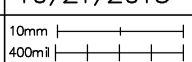

 MICROCHIP Microchip Technology Inc. 2355 W. Chandler Blvd. Chandler, AZ 85224	TITLE: MCP25625 PICTail Plus		PROJECT PART NUMBER: ADM00617
	PCB DESIGNER: Fernando Gonzalez	GERBER FILE: TOP Copper & Silk	
	ENGINEER: Fernando Gonzalez	BOARD NUMBER: 04-10350	DATE: 10/21/2015
	PCB FILE NAME: MCP25625 PICTail Plus.PcbDoc	LAYER NAME: BOARD (1/2)	REV: 1
			

1 2 3 4 5 6

REV	ECO	Comments	Date

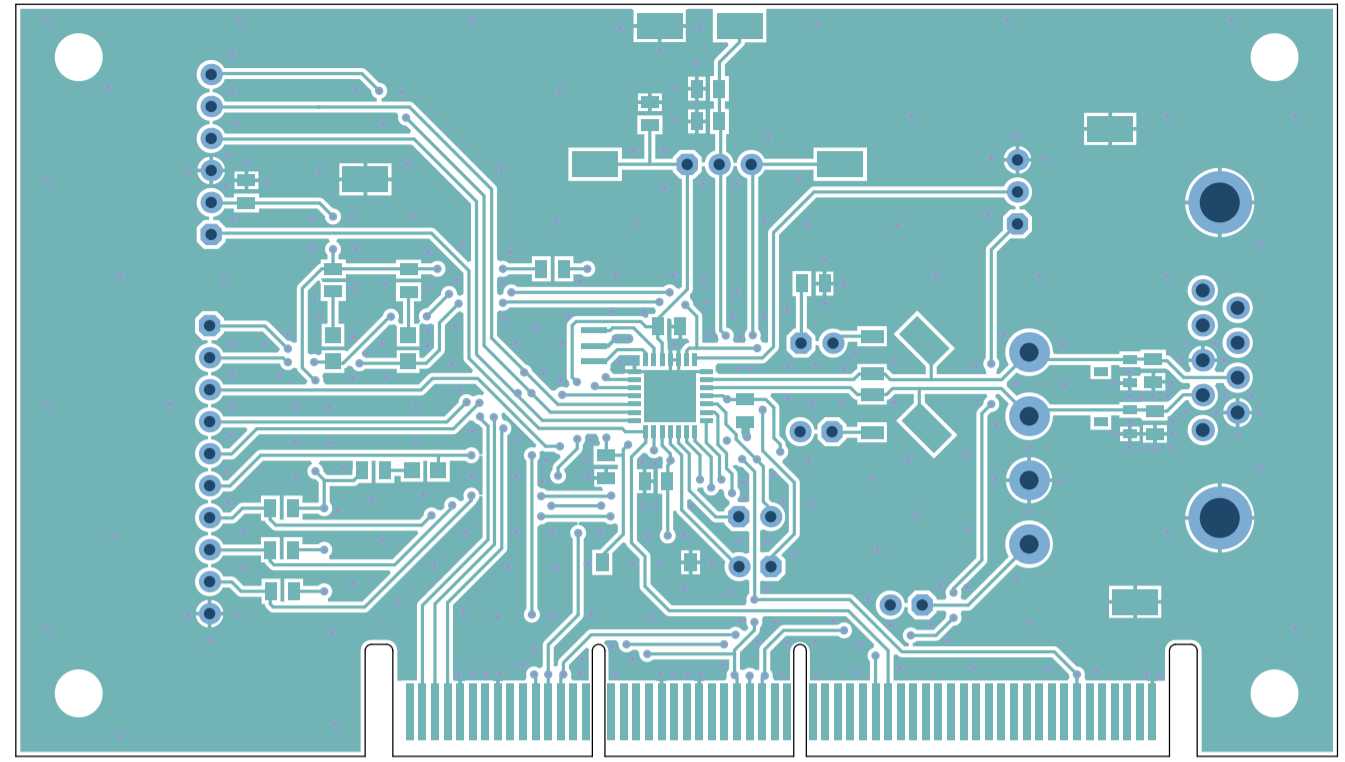

A

A

B

B

C

C

D

D

1 2 3 4 5 6

 MICROCHIP Microchip Technology Inc. 2355 W. Chandler Blvd. Chandler, AZ 85224	TITLE: MCP25625 PICTail Plus		PROJECT PART NUMBER: ADM00617
	PCB DESIGNER: Fernando Gonzalez	GERBER FILE: TOP Copper	
	ENGINEER: Fernando Gonzalez	BOARD NUMBER: 04-10350	DATE: 10/21/2015
	PCB FILE NAME: MCP25625 PICTail Plus.PcbDoc	LAYER NAME: BOARD (M2)	REV: 1

1 2 3 4 5 6

1 2 3 4 5 6

A

A

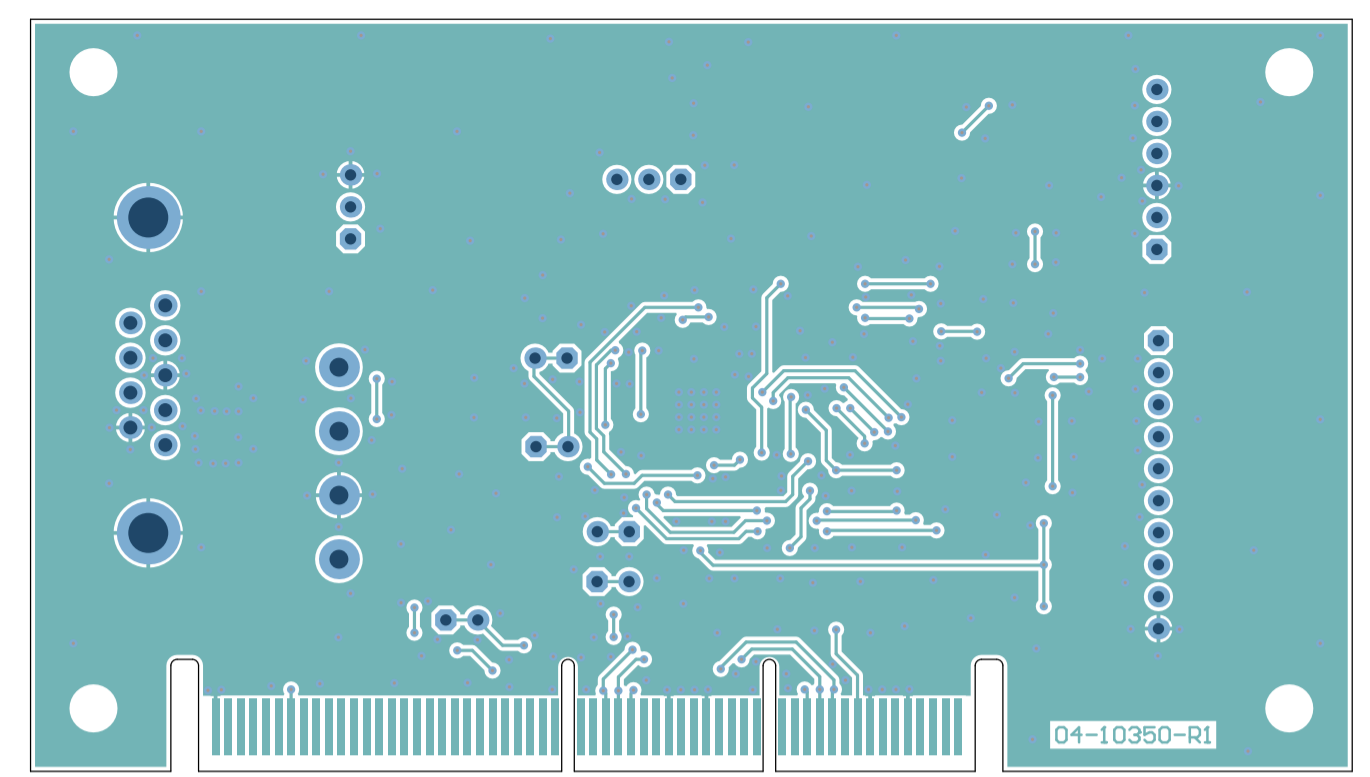

B

B

C

C

D

D

 MICROCHIP Microchip Technology Inc. 2355 W. Chandler Blvd. Chandler, AZ 85224	TITLE: MCP25625 PICTail Plus		PROJECT PART NUMBER: ADM00617
	PCB DESIGNER: Fernando Gonzalez	GERBER FILE: BOTTOM Copper	
	ENGINEER: Fernando Gonzalez	BOARD NUMBER: 04-10350	DATE: 10/21/2015
	PCB FILE NAME: MCP25625 PICTail Plus.PcbDoc	LAYER NAME:	REV: 10mm 400mil

1 2 3 4 5 6

BOARD (MS) (SM)

1 2 3 4 5 6

A

A

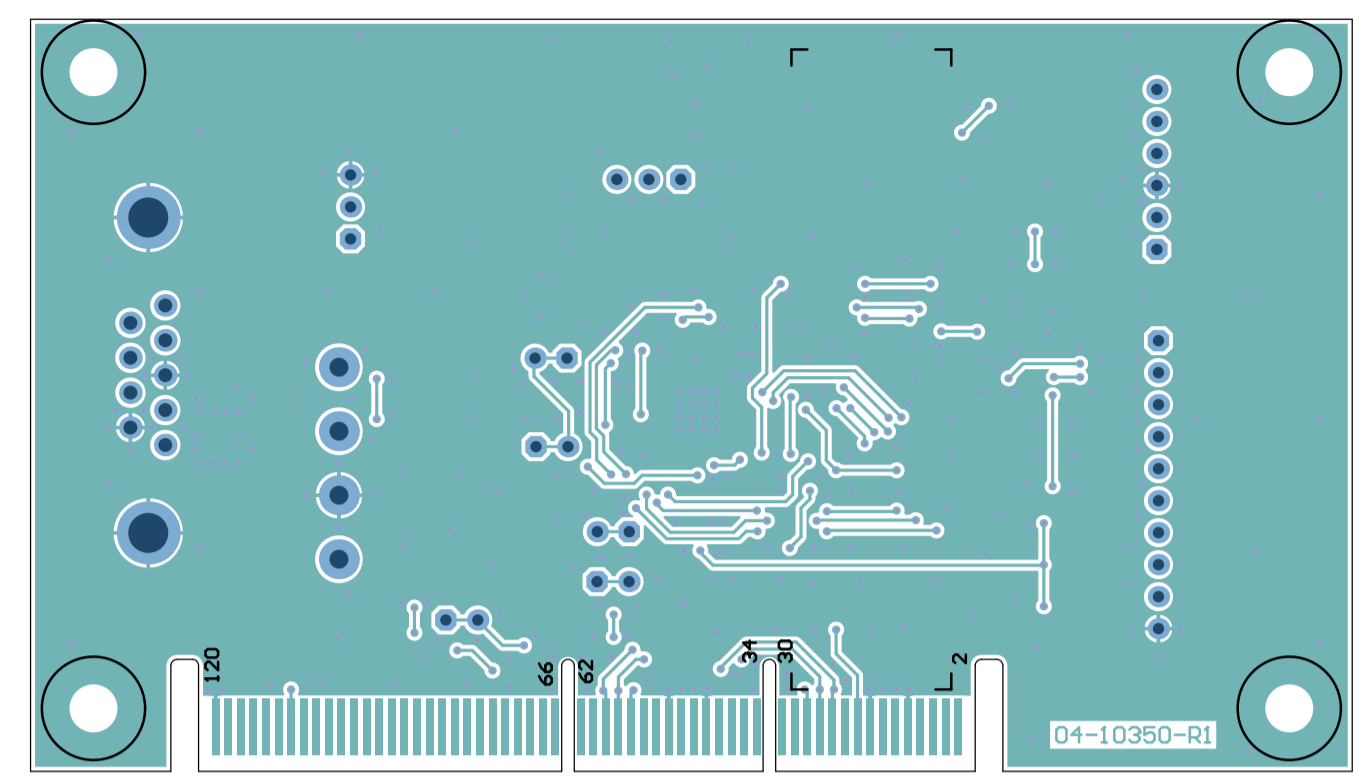

B

B

C

C

D

D

 MICROCHIP Microchip Technology Inc. 2355 W. Chandler Blvd. Chandler, AZ 85224	TITLE: MCP25625 PICTail Plus		PROJECT PART NUMBER: ADM00617
	PCB DESIGNER: Fernando Gonzalez	GERBER FILE: Bottom Copper & Silk	
	ENGINEER: Fernando Gonzalez	BOARD NUMBER: 04-10350	DATE: 10/21/2015
	PCB FILE NAME: MCP25625 PICTail Plus.PcbDoc	LAYER NAME:	REV:

1 2 3 4 5 6

04-10350-R1

1 2 3 4 5 6

A

A

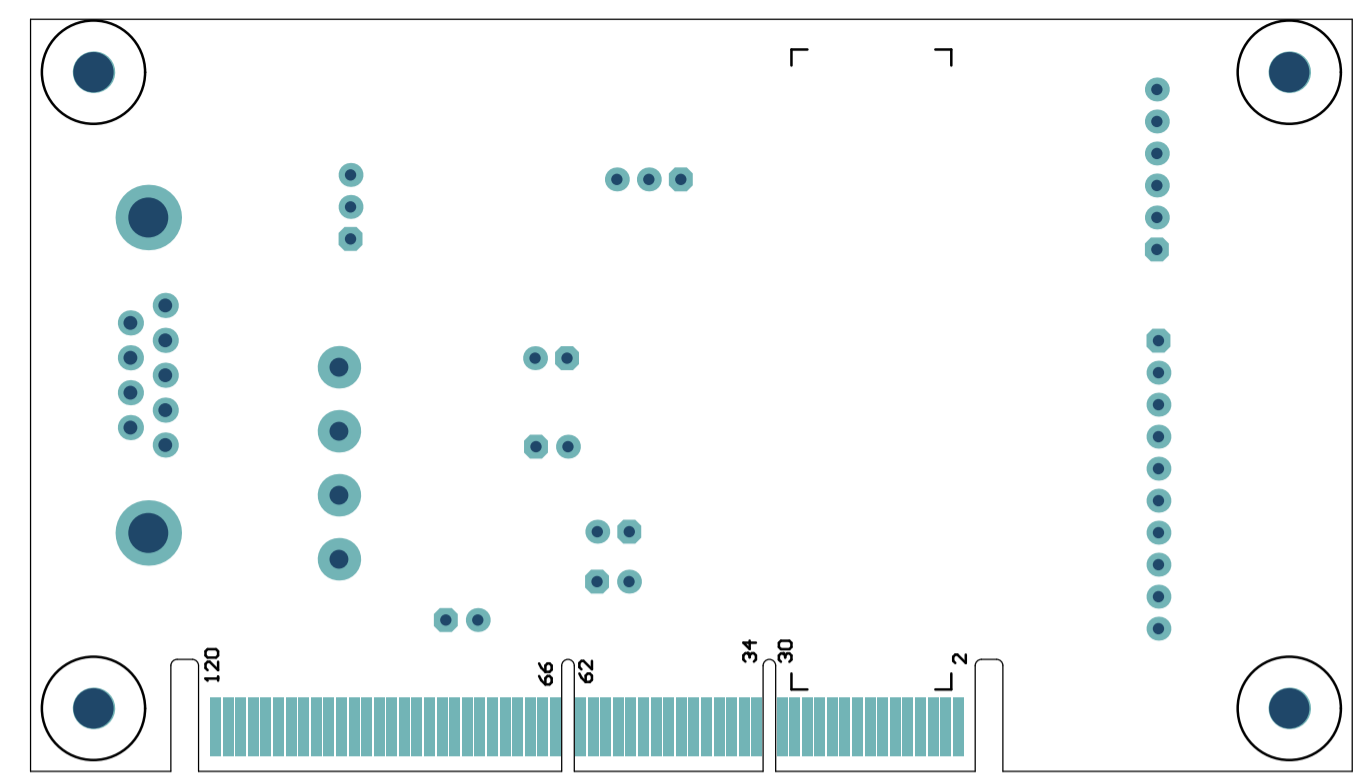

B

B

C

C

D

D

 MICROCHIP Microchip Technology Inc. 2355 W. Chandler Blvd. Chandler, AZ 85224	TITLE: MCP25625 PICTail Plus		PROJECT PART NUMBER: ADM00617		
	PCB DESIGNER: Fernando Gonzalez		GERBER FILE: BOTTOM Silk		
	ENGINEER: Fernando Gonzalez		BOARD NUMBER: 04-10350	DATE: 10/21/2015	
	PCB FILE NAME: MCP25625 PICTail Plus.PcbDoc		LAYER NAME:	REV:	10mm 400mil

1 2 3 4 5 6

10/21/2015

REV	ECO#	DESCRIPTION	DATE

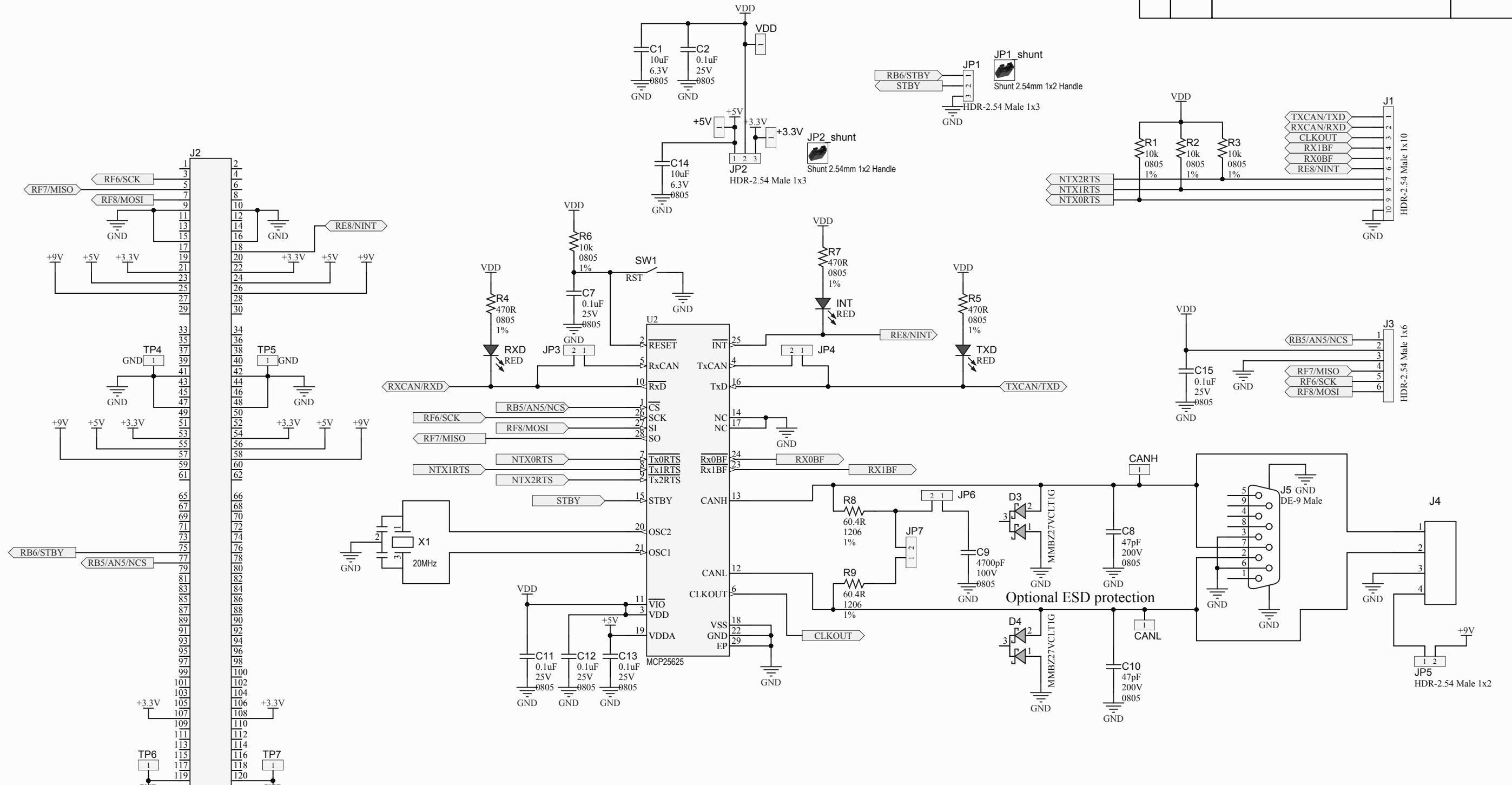

Drawn By: Fernando Gonzalez	MICROCHIP
Engineer: Fernando Gonzalez	
PartNumber: ADM00617	Project Title MCP25625 PICTail Plus
Sheet Title Full Schematic	
Size B	Sch #:03-10350 Revision:1
Date: 10/21/2015 3:12:43 PM	Sheet 1 of 1
File: MCP25625 PICTail Plus.SchDoc	

Need Help?
http://support.microchip.com
Assy# Serial #
LABEL1

- PAD1
 SJ61A11
- PAD2
 SJ61A11
- PAD3
 SJ61A11
- PAD4
 SJ61A11

