

FEMALE PLUG M12 90° ANGLED TO MALE PLUG M12 90° ANGLED

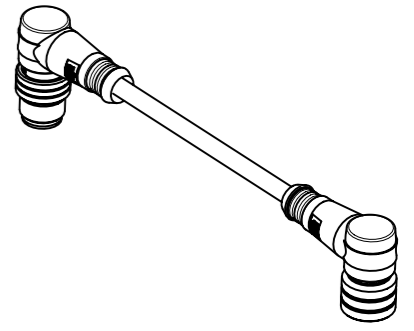
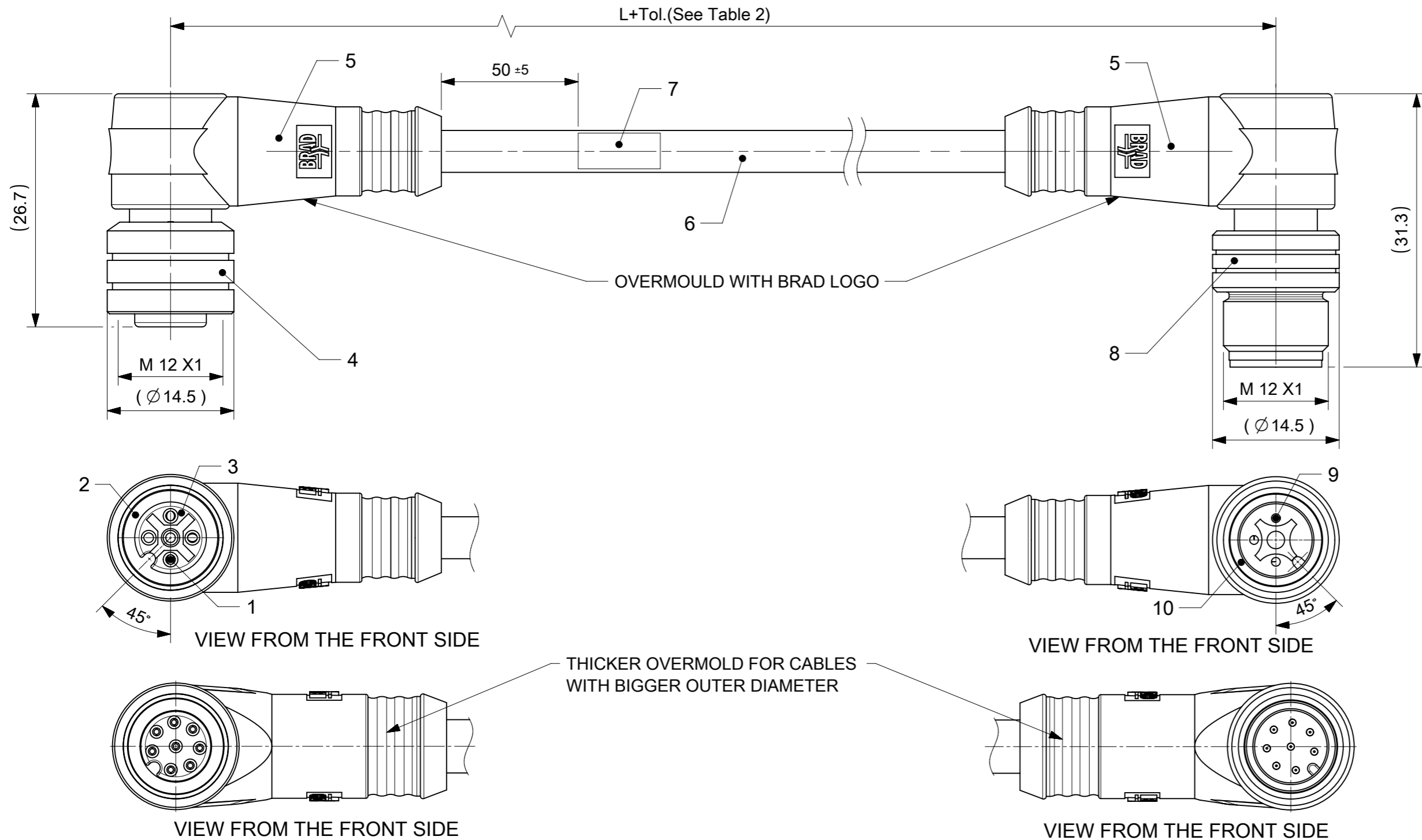

SCALE 1:2

BILL OF MATERIALS

ITEM	QTY.	DESCRIPTION	MATERIAL	FINISH/COLOR
10	1	INSERT MALE	PUR	BLACK
9	3	CONTACT M12 MALE	BRASS	SELECTIVE GOLD OVER NICKEL
8	1	COUPLING NUT MALE	BRASS	NICKEL
7	1	LABEL	VINYL	YELLOW
6	-	CABLE	SEE MATRIX/ CABLE SPECIFICATION	SEE CABLE SPECIFICATION
5	1	OVERMOULD	TPU	SEE MATRIX
4	1	COUPLING NUT FEMALE	BRASS	NICKEL
3	1	INSERT FEMALE	PUR	BLACK
2	1	O-RING	FPM	RED
1	3	CONTACT M12 FEMALE	BRASS	SELECTIVE GOLD OVER NICKEL

NOTES:

CONTACT CURRENT RATING: 3-5 POLES 4A
8 POLES 2A
VOLTAGE RATING: 3-4 POLES 250V
5 POLES 60V DC
8 POLES 30V
PROTECTION CLASS: IP 67
TEMPERATURE: -25°C / +85°C

THIS DRAWING CONTAINS INFORMATION THAT IS PROPRIETARY TO MOLEX ELECTRONIC TECHNOLOGIES, LLC AND SHOULD NOT BE USED WITHOUT WRITTEN PERMISSION												
DIMENSION UNITS mm		SCALE 2:1		CURRENT REV DESC: REMOVED OBSOLETE PART NUMBERS AS PER PCN#510807.								
GENERAL TOLERANCES (UNLESS SPECIFIED)												
ANGULAR TOL ± 1.0°												
4 PLACES ±		EC NO: 726454		2022/10/27		CSE M12 XP AC FE RA MA RA XM						
3 PLACES ±		DRWN: LIKITV		2022/11/30								
2 PLACES ± 0.05		CHK'D: GGA		2022/11/30		PRODUCT CUSTOMER DRAWING						
1 PLACE ± 0.3		APPR: GGA		2022/11/30								
0 PLACES ± 0.5		INITIAL REVISION:		DOCUMENT NUMBER		DOC TYPE		DOC PART		REVISION		
DRAFT WHERE APPLICABLE MUST REMAIN WITHIN DIMENSIONS		THIRD ANGLE PROJECTION		DRAWING		SERIES		MATERIAL NUMBER		CUSTOMER		SHEET NUMBER
				A3-SIZE		120007		1200070187		PSD 000 A4		1 OF 3
								SEE TABLE		GENERAL MARKET		

ENGINEERING NO. - NUMERICAL CODE (Available parts see PART LIST table. Others on request).

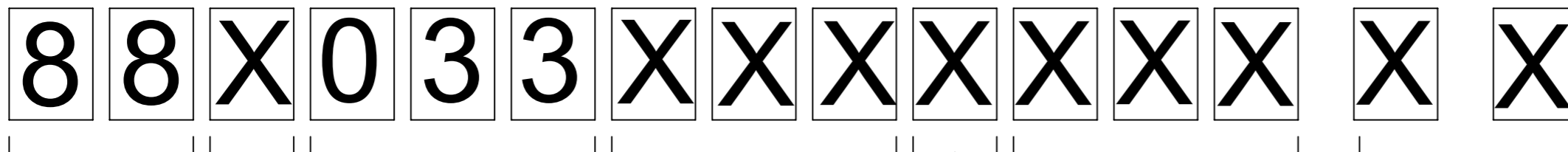

88 = M12x1
Double ended

Poles:
3 = 3 Poles
4 = 4 Poles
5 = 5 Poles

Heads style:
033 = Plugs FE 90° &
Male 90°

Cable types:
E02=0.25mm² PVC Black
E03=0.34mm² PVC Black
E13=0.75mm² PVC Yellow
E52=0.34mm² PVC Grey(RAL 7001)
E57=0.34mm² PVC Grey(RAL 7001)
H09=0.34mm² PUR Black
H69=0.34mm² PUR Grey LSOH SCR
I02=0.25mm² PVC Grey CEI
I03=0.34mm² PVC Grey CEI
I20=0.25mm² PVC Grey CEI SCR DC
I26=0.34mm² PVC Grey CEI SCR AC
P02=0.25mm² PUR/PVC Black
P03=0.34mm² PUR/PVC Black
P08=0.25mm² PUR Yellow HIFLEX
P20=0.34mm² PUR Grey LSOH braid
P82=0.34mm² PUR orange irradiated DC
S20=0.34mm² PVC Yellow SJTO braid

Units:
C = Centimeter
M = Meter
K = Kilometer
F = Feet

Length
Examples:
020 = 2 M
060 = 6 M
100 = 10 M

Overmold color:
Blank (Standard)=Black TPU
Blank=Yellow PVC for cables
A09, S19, S20, S26
Blank=Yellow TPE-E for cables
K03, K05
A=Grey / G=Black / Y=Yellow

Coupling Nut:
Blank (Standard)=Knurled Brass Ni Plated
1=Hexagonal Stainless steel
5=Knurled Derlin
7=Knurled Brass Ni Plated, Teflon Coated
Blank=7 for cables I20, I26, K03, K05, P82, S26
9=Knurled / Hexagonal Brass Ni Plated SW13

H= 2 pcs. of I/D Carrier PVC Transparent
(Cables lxx & P82 always with 2 pcs. of
I/D Carrier even if no H in Engineering No.)

COUPLING NUT
FEMALE MALE

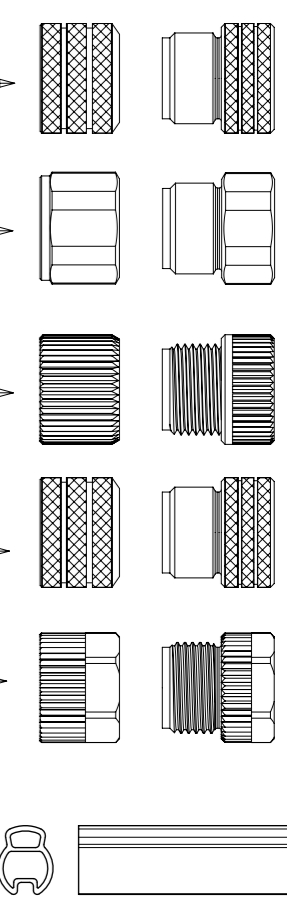

CABLE SPECIFICATION

CABLE TYPE	NO. OF WIRES	CROSS SECTION	CABLE JACKET	UL	CSA	STATIC: TEMP. / BENDING RADIUS	DYNAMIC: TEMP. / BENDING RADIUS	DRAG CHAIN	SHIELD
E03	3 / 4 / 5	0.34mm²	PVC BLACK	UL 2464/1729	C22.2 I/II A/B 80°C/300V	-30°C to +80°C, 10xO.D.	-10°C to +80°C, 15xO.D.	-	-
E13	3	AWG18	PVC YELLOW	UL 1731/AWM 2661	AWM C I/II A/B 80°C/300V	-	-	-	-
H09	3 / 4 / 5	0.34mm²	PUR BLACK LS0H	UL 21198/10493	C22.2 I/II A/B 80°C/300V	-40°C to +80°C, 5xO.D.	-25°C to +80°C, 10xO.D.	2 000 000 cycles at 20°C, Temp. range +5°C to +60°C	-
P03	3 / 4 / 5	0.34mm²	PUR / PVC BLACK	-	-	-30°C to +80°C, >7xO.D.	-5°C to +80°C, >15xO.D.	-	-
P82	4	0.34mm²	PUR IRR ORANGE	-	-	-50°C to +105°C,	-50°C to +105°C,	-	-
I03	4	0.34mm²	PVC GRAY	-	-	-30°C to +70°C	-5°C to +70°C	-	-
K03	4	AWG18	TPE YELLOW	ITC E195601 OR PLTC	AWM I/II A/B FT4 LL54185	-	-40°C to +105°C	-	-
K05	4	0.34mm²	TPE YELLOW	ITC E195601 OR PLTC	AWM I/II A/B FT4 LL54185	-	-40°C to +105°C	-	-
S20	4	0.34mm²	PVC YELLOW	UL 2661/1731	C22.2 AWM II	-30°C to +105°C	-40°C to +105°C	-	-

CONTACT POSITION FRONT VIEW:

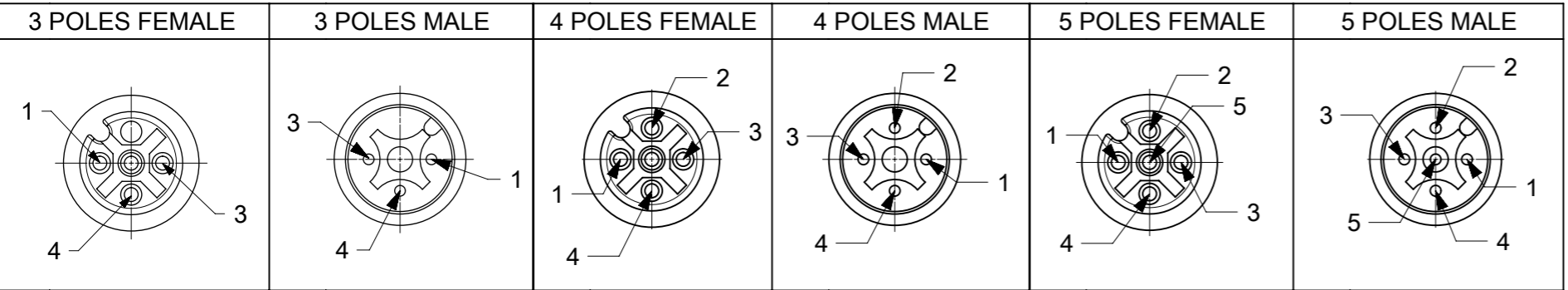

PIN	WIRE	PIN	WIRE	PIN	WIRE	PIN	WIRE	PIN	WIRE	PIN	WIRE	PIN	WIRE
1	BROWN	1	BROWN	1	BROWN	1	BROWN	1	BROWN	1	BROWN	1	BROWN
2	-	2	-	2	WHITE	2	WHITE	2	WHITE	2	WHITE	2	WHITE
3	BLUE	3	BLUE	3	BLUE	3	BLUE	3	BLUE	3	BLUE	3	BLUE
4	BLACK	4	BLACK	4	BLACK	4	BLACK	4	BLACK	4	BLACK	4	BLACK
5	-	5	-	5	-	5	-	5	GREY OR GREEN/YELLOW	5	GREY OR GREEN/YELLOW	5	GREY OR GREEN/YELLOW

OVER	UPTO AND INCLUDING	TOLERANCE
0	305	+19
305	915	+45
915	1830	+56
1830	3660	+89
3660	7320	+165
7320	14640	+317
14640	30500	+610
30500	>	+2% OF LENGTH

THIS DRAWING CONTAINS INFORMATION THAT IS PROPRIETARY TO MOLEX ELECTRONIC TECHNOLOGIES, LLC AND SHOULD NOT BE USED WITHOUT WRITTEN PERMISSION

mm SCALE 1:1

GENERAL TOLERANCES (UNLESS SPECIFIED)

ANGULAR TOL ± 1.0°

4 PLACES ±

3 PLACES ±

2 PLACES ± 0.05

1 PLACE ± 0.3

0 PLACES ± 0.5

DRAFT WHERE APPLICABLE MUST REMAIN WITHIN DIMENSIONS

THIRD ANGLE PROJECTION

DRAWING A3-SIZE

SERIES 120007

MATERIAL NUMBER SEE TABLE

CUSTOMER GENERAL MARKET

SHEET NUMBER 2 OF 3

EC NO: 726454
DRWN: LIKITV
CHK'D: GGA
APPR: GGA

INITIAL REVISION:
DRWN: DSOPPIN
APPR: RSILLER

2022/10/27
2022/11/30
2022/11/30

2018/09/27
2018/10/22

DOCUMENT NUMBER 1200070187

DOC TYPE PSD

DOC PART 000

REVISION A4

molex

CSE M12 XP AC FE RA MA RA XM

PRODUCT CUSTOMER DRAWING

DOCUMENT STATUS	P1	RELEASE DATE	2022/11/30	11:33:40
-----------------	----	--------------	------------	----------

PART LIST

MOLEX PN	ENGINEERING PN	LENGTH (mm)
1200070187	883033E03M003	300
1200669514	883033E03M006H	600
1200070190	883033E03M020	2000
1200668685	883033E03M030	3000
1200668668	883033E03M050	5000
1200668398	883033E03M100	10000
1200668539	883033E03M150	15000
1200668253	883033E03M200	20000
1200668351	883033E13M005	500
1200668498	883033H09M010	1000
1200070203	883033I03M006	600
1200070204	883033I03M010	1000
1200070207	883033I03M050	5000
1200070208	883033I03M100	10000
1200071856	883033I03M1005	10000
1200070209	883033I03M150	15000
1200668295	883033P03M003	300
1200070215	883033P03M006	600
1200070216	883033P03M010	1000
1200070217	883033P03M020	2000
1200070817	883033P03M050	5000
1200668178	884033E03M003	300
1200669210	884033E03M0038	300
1200669211	884033E03M0068	600
1200668757	884033E03M008	800
1200070554	884033E03M010	1000
1200668192	884033E03M020	2000
1200072331	884033E03M0201	2000
1200070556	884033E03M030	3000
1200070557	884033E03M050	5000
1200668492	884033H09M010	1000
1200668240	884033H09M020	2000
1200668243	884033H09M050	5000
1200668260	884033I03M010	1000
1200668261	884033I03M020	2000
1200668262	884033I03M0305	3000
1200668263	884033I03M0505	5000
1200668264	884033I03M1005	10000
1200661370	884033K03M006	600
1200661371	884033K03M010	1000
1200661373	884033K03M020	2000
1200661374	884033K03M030	3000
1200661599	884033K03M036	3600

MOLEX PN	ENGINEERING PN	LENGTH (mm)
1200661376	884033K03M050	5000
1200661380	884033K05M005	500
1200661382	884033K05M010	1000
1200661383	884033K05M015	1500
1200661384	884033K05M020	2000
1200071524	884033P03M006	600
1200071523	884033P03M010	1000
1200668275	884033P03M015	1500
1200668332	884033P03M020	2000
1200668179	884033P03M020H	2000
1200668217	884033P03M030	3000
1200668298	884033P03M050	5000
1200669900	884033P03M100	10000
1200070565	884033S20M010	1000
1200665402	885033E03M010	1000
1200668529	885033E03M010H	1000
1200668675	885033E03M020	2000
1200668676	885033E03M030	3000
1200668677	885033E03M050	5000
1200668678	885033E03M100	10000
1200668499	885033H09M010	1000
1200668679	885033H09M020	2000
1200668680	885033H09M030	3000
1200668681	885033H09M050	5000
1200668682	885033H09M100	10000
1200668871	885033P03C130	130
1200668346	885033P03M003	300
1200668094	885033P03M010	1000
1200073087	885033P03M020	2000
1200072660	885033P03M030	3000
1200073088	885033P03M050	5000
1200072657	885033P03M0755	7500
1200073089	885033P03M100	10000

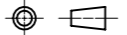
THIS DRAWING CONTAINS INFORMATION THAT IS PROPRIETARY TO MOLEX ELECTRONIC TECHNOLOGIES, LLC AND SHOULD NOT BE USED WITHOUT WRITTEN PERMISSION									
DIMENSION UNITS	SCALE	CURRENT REV DESC: REMOVED OBSOLETE PART NUMBERS AS PER PCN#510807.							
mm	1:1	 CSE M12 XP AC FE RA MA RA XM							
GENERAL TOLERANCES (UNLESS SPECIFIED)									
ANGULAR TOL	± 1.0 °	EC NO: 726454 DRWN: LIKITV 2022/10/27 CHK'D: GGA 2022/11/30 APPR: GGA 2022/11/30							
4 PLACES	±								
3 PLACES	±	INITIAL REVISION: DRWN: DSOPPIN 2018/09/27 APPR: RSILLER 2018/10/22							
2 PLACES	± 0.05								
1 PLACE	± 0.3	DOCUMENT NUMBER			DOC TYPE		DOC PART		REVISION
0 PLACES	± 0.5	1200070187			PSD		000		A4
DRAFT WHERE APPLICABLE MUST REMAIN WITHIN DIMENSIONS		THIRD ANGLE PROJECTION	DRAWING	SERIES	MATERIAL NUMBER	CUSTOMER		SHEET NUMBER	
			A3-SIZE	120007	SEE TABLE	GENERAL MARKET		3 OF 3	

DOCUMENT STATUS	P1	RELEASE DATE	2022/11/30	11:33:40
-----------------	----	--------------	------------	----------