

OMNIMATE Signal - series B2C/S2C 3.50 - 2-row B2CF 3.50/14/180LR SN OR BX

Weidmüller Interface GmbH & Co. KG
Klingenbergstraße 16
D-32758 Detmold
Germany
Fon: +49 5231 14-0
Fax: +49 5231 14-292083
www.weidmueller.com

Product image



Similar to illustration

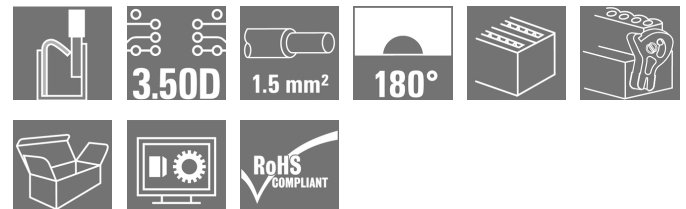

Two-row female plug with PUSH IN spring connection

- Simply insert the prepared wire - and you're done
- Intuitive to use because
- the wire-entry area and handling area are clearly separated
- Integrated push-buttons for opening the terminal point
- High component density because of low heights
- Optional: locking and releasing require no tools when using Weidmüller's release latch (LR) or release lever (LH)

General ordering data

Type	B2CF 3.50/14/180LR SN OR BX
Order No.	1278090000
Version	PCB plug-in connector, female plug, 3.50 mm, No. of poles: 14, 180°, PUSH IN, Tension-clamp connection, Clamping range, max.: 1.5 mm², Box
GTIN (EAN)	4050118068221
Qty.	60 pc(s).
Product data	IEC: 320 V / 13.4 A / 0.14 - 1.5 mm² UL: 300 V / 9.5 A / AWG 26 - AWG 16
Packaging	Box

**OMNIMATE Signal - series B2C/S2C 3.50 - 2-row
B2CF 3.50/14/180LR SN OR BX**

Weidmüller Interface GmbH & Co. KG
Klingenbergstraße 16
D-32758 Detmold
Germany
Fon: +49 5231 14-0
Fax: +49 5231 14-292083
www.weidmueller.com

Technical data
Dimensions and weights

Width	31.4 mm	Width (inches)	1.236 inch
Height	17.25 mm	Height (inches)	0.679 inch
Depth	29.9 mm	Depth (inches)	1.177 inch
Net weight	9.956 g		

System parameters

Product family	OMNIMATE Signal - series B2C/S2C 3.50 - 2-row	Type of connection	Field connection
Wire connection method	PUSH IN, Tension-clamp connection	Pitch in mm (P)	3.5 mm
Pitch in inches (P)	0.138 inch	Conductor outlet direction	180°
No. of poles	14	L1 in mm	21 mm
L1 in inches	0.827 inch	Number of rows	1
Pin series quantity	2	Rated cross-section	1.5 mm ²
Touch-safe protection acc. to DIN VDE 57 106	Safe from finger touch	Touch-safe protection acc. to DIN VDE 0470	IP 20
Can be coded	Yes	Stripping length	10 mm
Actuating force actuating element, max.	40 N	Screwdriver blade	0.4 x 2.5
Screwdriver blade standard	DIN 5264	Plugging cycles	25
Plugging force/pole, max.	5 N	Pulling force/pole, max.	5 N

Material data

Insulating material	PA 66 GF 30	Colour code	orange
Colour chart (similar)	RAL 2000	Insulating material group	II
CTI	≥ 600	Insulation strength	≥ 10 ⁸ Ω
UL 94 flammability rating	V-0	Contact material	Copper alloy
Contact surface	tinned	Layer structure of plug contact	2-5 μm Sn hot-dip tinned
Storage temperature, min.	-25 °C	Storage temperature, max.	55 °C
Max. relative humidity during storage	80 %	Operating temperature, min.	-50 °C
Operating temperature, max.	120 °C	Temperature range, installation, min.	-40 °C
Temperature range, installation, max.	120 °C		

Conductors suitable for connection

Clamping range, min.	0.14 mm ²	Clamping range, max.	1.5 mm ²
Solid, min. H05(07) V-U	0.14 mm ²	Solid, max. H05(07) V-U	1.5 mm ²
Flexible, min. H05(07) V-K	0.14 mm ²	Flexible, max. H05(07) V-K	1.5 mm ²
w. plastic collar ferrule, DIN 46228 pt 4, min.	0.14 mm ²	w. plastic collar ferrule, DIN 46228 pt 4, max.	1 mm ²
w. wire end ferrule, DIN 46228 pt 1, min	0.14 mm ²	w. wire end ferrule, DIN 46228 pt 1, max.	1.5 mm ²

**OMNIMATE Signal - series B2C/S2C 3.50 - 2-row
B2CF 3.50/14/180LR SN OR BX**

Weidmüller Interface GmbH & Co. KG
 Klingenbergstraße 16
 D-32758 Detmold
 Germany
 Fon: +49 5231 14-0
 Fax: +49 5231 14-292083
 www.weidmueller.com

Technical data**Rated data acc. to IEC**

tested acc. to standard	IEC 60664-1, IEC 61984	Rated current, min. no. of poles (Tu=20°C)	13.4 A
Rated current, max. no. of poles (Tu=20°C)	10 A	Rated current, min. no. of poles (Tu=40°C)	12 A
Rated current, max. no. of poles (Tu=40°C)	9 A	Rated voltage for surge voltage class / pollution degree II/2	320 V
Rated voltage for surge voltage class / pollution degree III/2	160 V	Rated voltage for surge voltage class / pollution degree III/3	160 V
Rated impulse voltage for surge voltage class/ pollution degree II/2	2.5 kV	Rated impulse voltage for surge voltage class/ pollution degree III/2	2.5 kV
Rated impulse voltage for surge voltage class/ contamination degree III/3	2.5 kV	Short-time withstand current resistance	3 x 1s with 80 A

Rated data acc. to CSA

Institute (CSA)		Certificate No. (CSA)	200039-1121690
Rated voltage (Use group B / CSA)	300 V	Rated voltage (Use group C / CSA)	50 V
Rated voltage (Use group D / CSA)	300 V	Rated current (Use group B / CSA)	9.5 A
Rated current (Use group C / CSA)	9.5 A	Rated current (Use group D / CSA)	9.5 A
Wire cross-section, AWG, min.	AWG 26	Wire cross-section, AWG, max.	AWG 16
Reference to approval values	Specifications are maximum values, details - see approval certificate.		

Rated data acc. to UL 1059

Institute (cURus)		Certificate No. (cURus)	E60693
Rated voltage (Use group B / UL 1059)	300 V	Rated voltage (Use group C / UL 1059)	50 V
Rated voltage (Use group D / UL 1059)	300 V	Rated current (Use group B / UL 1059)	9.5 A
Rated current (Use group C / UL 1059)	9.5 A	Rated current (Use group D / UL 1059)	9.5 A
Wire cross-section, AWG, min.	AWG 26	Wire cross-section, AWG, max.	AWG 16
Reference to approval values	Specifications are maximum values, details - see approval certificate.		

Packaging

Packaging	Box	VPE length	35 mm
VPE width	135 mm	VPE height	350 mm

Classifications

ETIM 4.0	EC002637	ETIM 5.0	EC002637
ETIM 6.0	EC002637	eClass 6.2	27-26-07-04
eClass 7.1	27-44-04-02	eClass 8.1	27-44-04-02
eClass 9.0	27-44-04-02	eClass 9.1	27-44-04-02

**OMNIMATE Signal - series B2C/S2C 3.50 - 2-row
B2CF 3.50/14/180LR SN OR BX**

Weidmüller Interface GmbH & Co. KG
Klingenbergstraße 16
D-32758 Detmold
Germany
Fon: +49 5231 14-0
Fax: +49 5231 14-292083
www.weidmueller.com

Technical data

Notes

Notes

- Additional colours on request
- Gold-plated contact surfaces on request
- Rated current related to rated cross-section & min. No. of poles.
- Crimp shape A for wire-end ferrules with crimping tools PZ 1,5 (order no. 9005990000) or PZ 6/5 (order no. 9011460000) for larger wire cross-sections recommended.
- P on drawing = pitch
- Rated data refer only to the component itself. Clearance and creepage distances to other components are to be designed in accordance with the relevant application standards.
- Max. outer diameter of the conductor 2.6 mm

Wire-end ferrule w/plastic collar DIN 46228/4 or Weidmüller colour code

- 1.00mm² [H1.0/18D] mtl. ferrule leng. 12mm, stripping leng. 15mm
- 0.75mm² [H0.75/18D] mtl. ferrule leng. 12mm, stripping leng. 14mm
- 0.50mm² [H0.5/16D] mtl. ferrule leng. 10mm, stripping leng. 12mm
- 0.34mm² [H0.34/12] mtl. ferrule leng. 8mm, stripping leng. 10mm
- 0.25mm² [H0.25/12] mtl. ferrule leng. 8mm, stripping leng. 10mm
- 0.14mm² [H0.14/12] mtl. ferrule leng. 8mm, stripping leng. 10mm

Wire-end ferrule w/o plastic collar acc. to DIN 46228/1

- 1.50mm² [H1.5/10] mtl. ferrule leng. 10mm, stripping leng. 10mm

Wire-end ferrule w/plastic collar DIN 46228/4 and 2 connec. cables

- 2 x 0.20mm² [H0.5/16] mtl. ferrule leng. 10mm, stripping leng. 12mm
- 2 x 0.34mm² [H1.0/18] mtl. ferrule leng. 12mm, stripping leng. 15mm

IPC conformity

Conformity: The products are developed, manufactured and delivered according international recognized standards and norms and comply with the assured properties in the data sheet resp. fulfill decorative properties in accordance with IPC-A-610 "Class 2". Further claims on the products can be evaluated on request.

Approvals

Approvals



ROHS

Conform

Data sheet

OMNIMATE Signal - series B2C/S2C 3.50 - 2-row B2CF 3.50/14/180LR SN OR BX

Weidmüller Interface GmbH & Co. KG
 Klingenbergstraße 16
 D-32758 Detmold
 Germany
 Fon: +49 5231 14-0
 Fax: +49 5231 14-292083
 www.weidmueller.com

Technical data

Downloads

Approval/Certificate/Document of Conformity	Declaration of the Manufacturer
Brochure/Catalogue	FL DRIVES EN MB DEVICE MANUF. EN FL DRIVES DE CAT 2 PORTFOLIOGUIDE EN FL BUILDING SAFETY EN FL APPL LED LIGHTING EN FLIndustr.CONTROLS EN FL MACHINE SAFETY EN FL HEATING ELECTR EN FL APPL INVERTER EN FL BASE STATION EN FL ELEVATOR EN FL POWER SUPPLY EN FL 72H SAMPLE SER EN PO OMNIMATE EN
Engineering Data	EPLAN_WSCAD
Engineering Data	STEP
User Documentation	Operating instruction
White Paper wire connection	Download Whitepaper

**OMNIMATE Signal - series B2C/S2C 3.50 - 2-row
B2CF 3.50/14/180LR SN OR BX**

Weidmüller Interface GmbH & Co. KG
Klingenbergstraße 16
D-32758 Detmold
Germany
Fon: +49 5231 14-0
Fax: +49 5231 14-292083
www.weidmueller.com

Drawings

Dimensional drawing

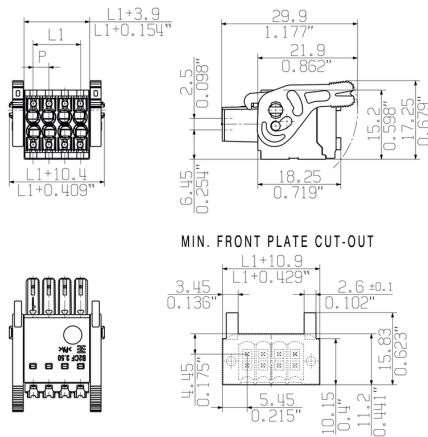

Graph

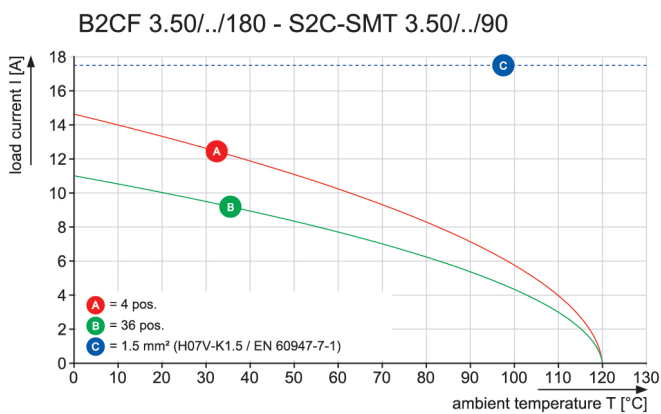

Product benefits

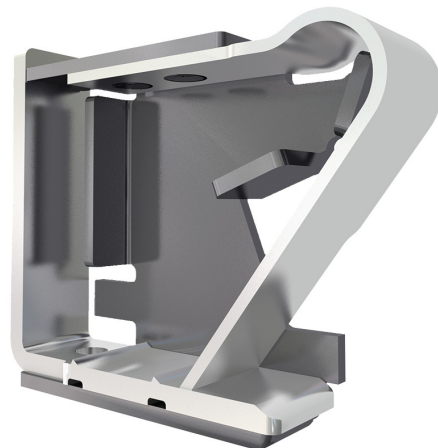

- Solid PUSH IN contact
- Safe and durable

Product benefits



- Large connection cross-section
- Up to 1.5 mm possible with ease

Product benefits



- Fast PUSH IN connection
- Tool-free and touch-safe

**OMNIMATE Signal - series B2C/S2C 3.50 - 2-row
B2CF 3.50/14/180LR SN OR BX**

Weidmüller Interface GmbH & Co. KG
Klingenbergstraße 16
D-32758 Detmold
Germany
Fon: +49 5231 14-0
Fax: +49 5231 14-292083
www.weidmueller.com

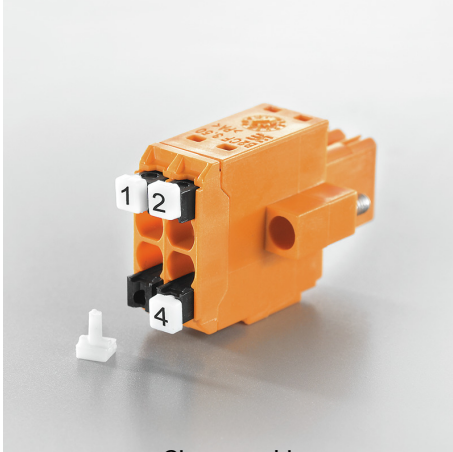
Product benefits

- Clear marking
- Unique designation

Example of use