

# MP-7070 -T110 LED (10 W)

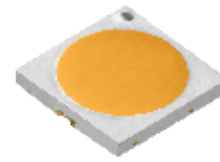

## Table of Contents

Technology Overview . . . . .2

Product Selection Table . . . .3

Operating Characteristics . .4

Chromaticity Diagram . . . . .5

Color Ranks . . . . .5

Chromaticity Coordinate Group  
 . . . . .6

Characteristics Graphs . . . .7

Solder Profile . . . . .8

Ordering Nomenclature . . . .9

Package dimension . . . . . 10

Soldering Pad Pattern . . . . 10

Dimension and Polarity . . . 11

Package Dimensions . . . 12

Inner Box . . . . . 13

## Features:

---

- High efficacy
- Low thermal resistance
- Compatible with automatic placement equipment
- Compatible with infrared reflow solder process
- RoHs and REACH compliant

## Applications

---

- |                     |                          |
|---------------------|--------------------------|
| • Replacement lamps | • Down lights            |
| • Panel lighting    | • Architectural lighting |

## Technology Overview

Luminus LEDs are lighting class solutions designed for high performance general lighting applications. These state-of-the-art LEDs allow illumination engineers and designers to develop lighting solutions with maximum efficacy, brightness and overall quality.

### Reliability

Luminus LED is one of the most reliable light sources in the world today. Having passed a rigorous suite of environmental and mechanical stress tests, including mechanical shock, vibration, temperature cycling and humidity, it is fully qualified for use in a wide range of high performance and high efficacy lighting applications.

### REACH & RoHS Compliance

The Luminus 7070 LED is compliant to the Restriction of Hazardous Substances Directive or RoHS. The restricted materials including lead, mercury cadmium hexavalent chromium, polybrominated biphenyls (PBB) and polybrominated diphenyl ether (PBDE) are not used.

## Understanding Luminus LED Test Specifications

Every Luminus LED is fully tested to ensure it meets the high quality standards customers have come to expect from Luminus products.

### Testing Temperature

XNova products are measured at a case solder point temperature of 25°C and placed into intensity, chromaticity and voltage bins as described here in

**Product Selection Table**

 Test condition = 280 mA,  $T_s = 25\text{ }^\circ\text{C}$ 

Nominal CCT	Minimum CRI	Ordering Part Number	Minimum Flux (Lumens)	Typical Flux (Lumens)
2700K	80	MP-7070-T110-27-80	1300	1380
	90	MP-7070-T110-27-90	1100	1180
3000K	80	MP-7070-T110-30-80	1300	1450
	90	MP-7070-T110-30-90	1100	1240
4000K	80	MP-7070-T110-40-80	1400	1540
	90	MP-7070-T110-40-90	1200	1320
5000K	80	MP-7070-T110-50-80	1400	1540
	90	MP-7070-T110-50-90	1200	1320
5700K	80	MP-7070-T110-57-80	1400	1540
	90	MP-7070-T110-57-90	1200	1320
6500K	80	MP-7070-T110-65-80	1400	1540
	90	MP-7070-T110-65-90	1200	1320

*\*IFP condition with Pulse: Width  $\leq 100\mu\text{s}$  Duty cycle  $\leq 1/10$*

*\*Tolerance of measurements of the Luminous Flux is  $\pm 7\%$*

*\*Ra measurement tolerance is  $\pm 2$*

*\*Correlated Color Temperature is derived from the CIE 1931 Chromaticity diagram*

*\*IFP condition with Pulse: Width  $\leq 100\mu\text{s}$  Duty cycle  $\leq 1/10$*

### 7070 Operating Characteristics

#### Optical and Electrical Characteristics(Ts=25°C)

Parameter	Symbol	Minimum	Typical	Maximum	Unit	Condition
Forward Voltage	$V_f$	36	37.7	40	V	$I_f=280\text{mA}$
Reverse Current	$I_r$			10	uA	$V_r=5\text{V}$
View Angle	$2\theta^{1/2}$		120		°	$I_f=280\text{mA}$
Thermal Resistance	$R_{th}_{j-sp}$		1.8		°C/W	$I_f=280\text{mA}$
Electrostatic Discharge	ESD	1000			V	

Note 1: To prevent damage refer to operating conditions and derating curves for appropriate maximum operating conditions

Note 2: Maximum operating case temperature combined with maximum drive current defines the total maximum operating condition for the device. To prevent damage, please follow derating curves for all operating conditions.

Note 3: LEDs are designed for operation up to an absolute maximum forward drive current as specified above. Product lifetime data is specified at typical forward drive currents. Sustained operation at absolute maximum currents will result in a reduction of device lifetime compared to typical forward drive currents. Actual device lifetimes will also depend on case temperature. Refer to the current vs. case temperature derating curves for further information.

Note 4: Caution must be taken not to stare at the light emitted from these LEDs. Under special circumstances, the high intensity could damage the eye.

#### Absolute Maximum Ratings (Ts=25°C)

Parameter	Symbol	Rating	Unit
Forward Current	$I_f$	350	mA
Pulse Forward Current	$I_{fp}$	525	mA
Power Dissipation	$P_d$	14	W
Reverse Voltage	$V_r$	5	V
Operating Temperature	$T_{opr}$	-40~+85	°C
Storage Temperature	$T_{sta}$	-40~+100	°C
Junction Temperature	$T_j$	125	°C
Soldering Temperature	$T_{sld}$	230 °C or 260 °C for 10 sec	

\*IFP condition with Pulse: Width  $\leq 100\mu\text{s}$  Duty cycle  $\leq 1/10$

### Chromaticity Diagram

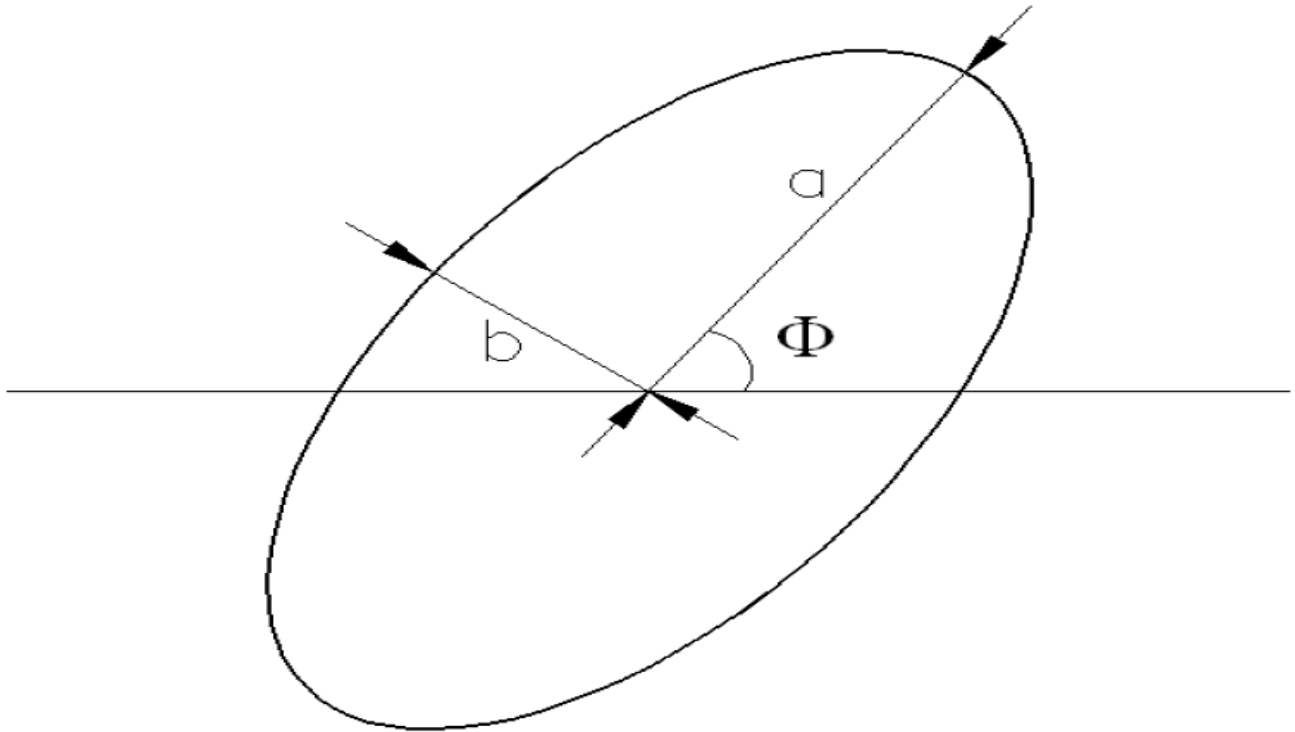

### Color Bins

Color Code	Center		Radius		Angle(deg)
	x	y	a	b	Φ
27m5	0.4620	0.4145	0.013500	0.007000	53.42
30m5	0.4383	0.4081	0.013900	0.006800	53.13
40m5	0.3875	0.3868	0.015650	0.006700	53.43
50m5	0.3507	0.3635	0.013700	0.005900	59.37
57m5	0.3348	0.3491	0.011175	0.005500	58.35
65m5	0.3187	0.3363	0.011150	0.004750	58.34

\*Note: Tolerance of measurements of the chromaticity Coordinate is  $\pm 0.005$   
Chromaticity coordinates as per ANSI standard.

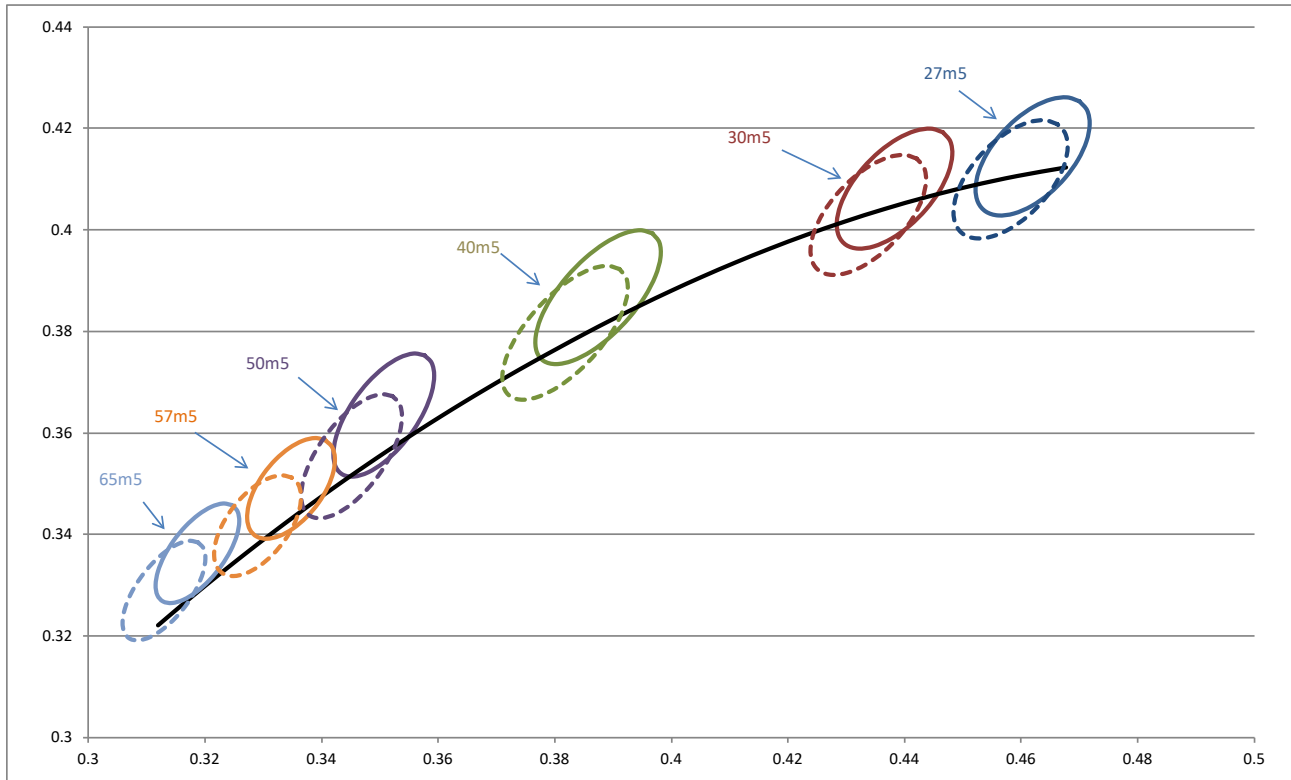
**Chromaticity Coordinate Group**

○  $T_j = 25\text{ }^\circ\text{C}$   
 ( )  $T_j = 85\text{ }^\circ\text{C}$

\*Note: Luminus maintains a +/- 0.01 tolerance on chromaticity (CIEx and CIEy) measurements.

Typical optical/Electrical Characteristics Graphs

COLOR SPECTRUM ( Ra≥80 Tj=25°C )

COLOR SPECTRUM ( Ra≥90 Tj=25°C )

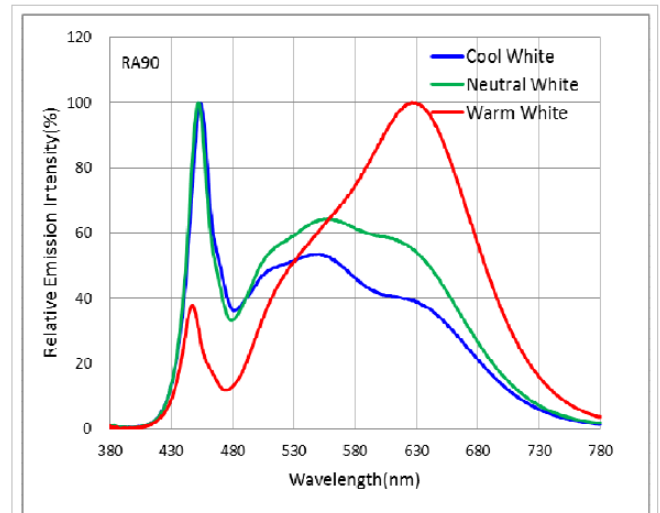
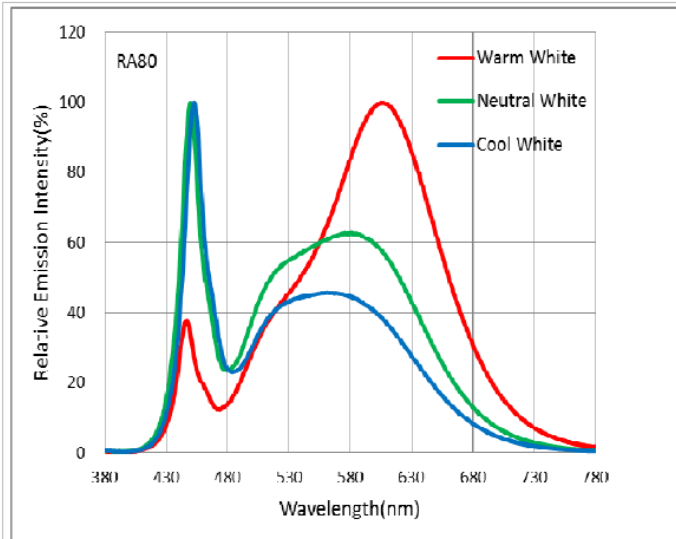

FORWARD CURRENT VS. RELATIVE INTENSITY

FORWARD CURRENT VS. FORWARD VOLTAGE

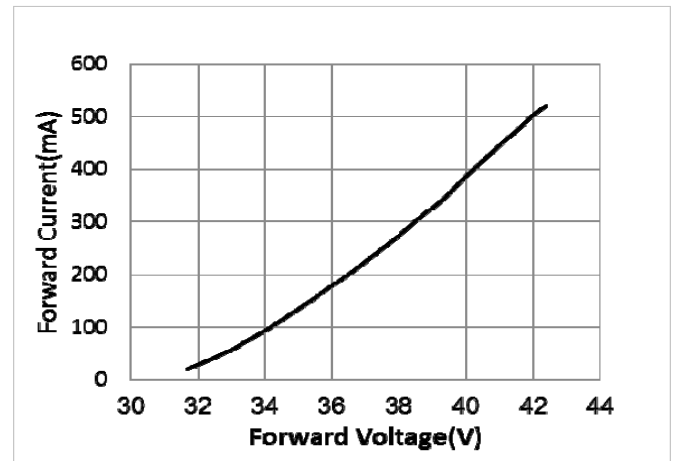
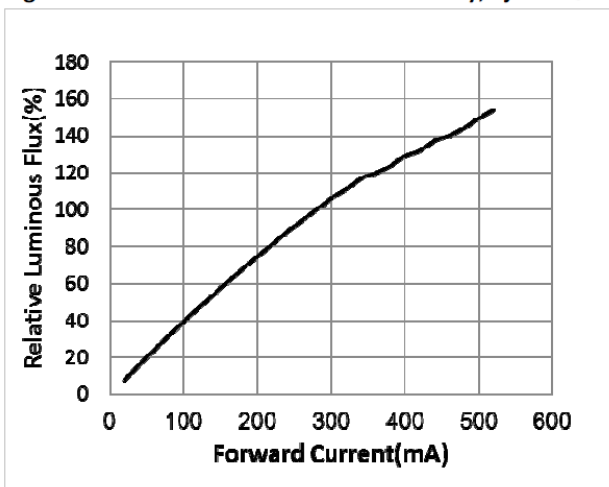

\*Note: Luminus maintains a +/- 0.01 tolerance on chromaticity (CIEx and CIEy) measurements.

Typical optical/Electrical Characteristics Graphs

Typical Polar Radiation Pattern

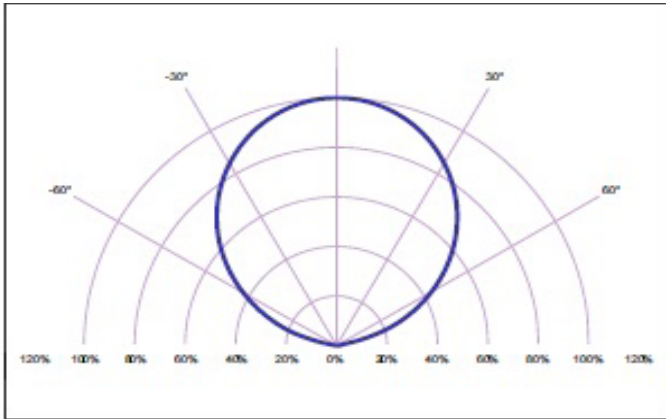

SOLDERING TEMP. VS. RELATIVE LUMINOUS FLUX

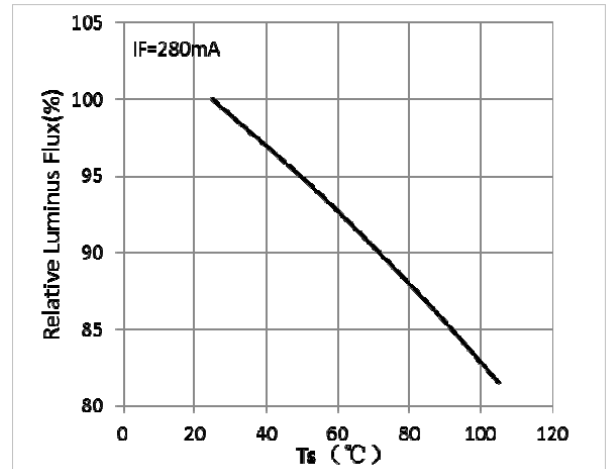

SOLDERING TEMP. VS. RELATIVE FORWARD VOLTAGE

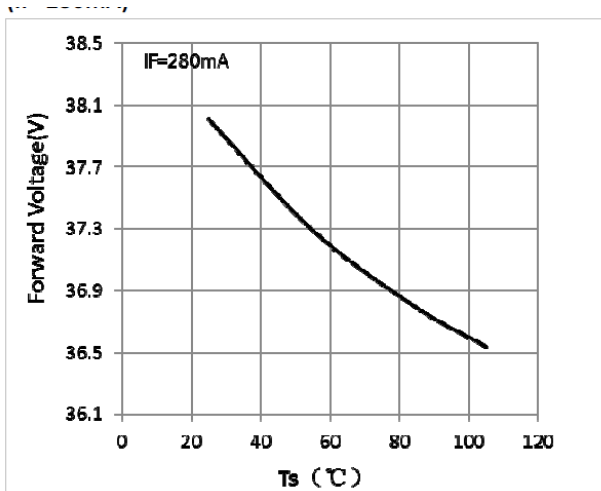

SOLDERING TEMP. VS. CIE<sub>x</sub>, Y SHIFT

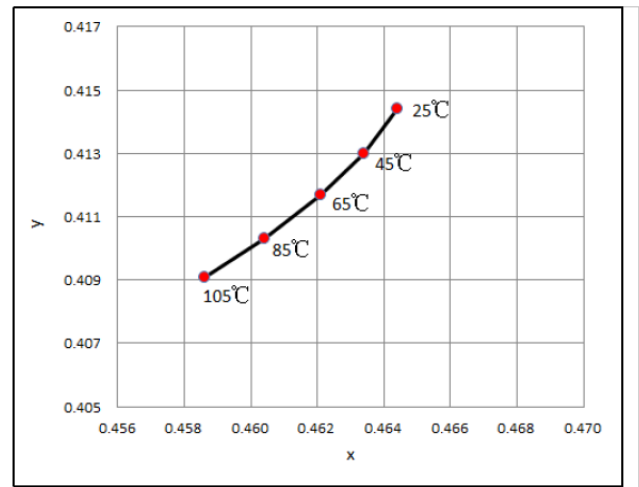

MAX FORWARD CURRENT VS. SOLDERING TEMP.

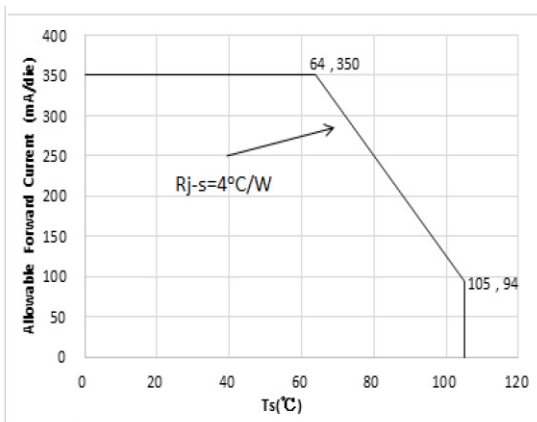



### Product Ordering and Shipping Part Number Nomenclature

All products are packaged and labeled with part numbers as outlined in below. When shipped, each reel will contain only a single flux and voltage bin. The part number designation is as follows:

#### 7070 LEDs

	Package Type	Package Configurator	Nominal CCT	Minimum CRI
MP	7070	T110	##	##

Example:

The part number MP-7070-1100-30-80 refers to a 7070 emitter with nominal color temperature of 3,000k and minimum CRI of 80. Please refer to page 5 for a description of available CCT and CRI combinations.

Note 1: CCT Codes:

27 = 2700 k  
 30 = 3000 k  
 40 = 4000 k  
 50 = 5000 k  
 57 = 5700 k  
 65 = 6500 k

Note 2: CRI Codes:

70  
 80

Each product shipped will be labeled with its specific flux and voltage bins. Not all bins listed are available in all CCTs and CRIs.

#### Luminus Flux Bins

Bin Code	Minimum Flux (Lumens)	Maximum Flux (Lumens)
3B	1100	1200
3C	1200	1300
3D	1300	1400
3E	1400	1500
3F	1500	1600
3G	1600	1700

#### Forward Voltage Bins (Ts=25°C)

Bin Code	Minimum Voltage (Volts)	Maximum Voltage (Volts)
6L	36	38
6M	38	40

\*Tolerance of measurements of the Forward Voltage is  $\pm 0.1V$

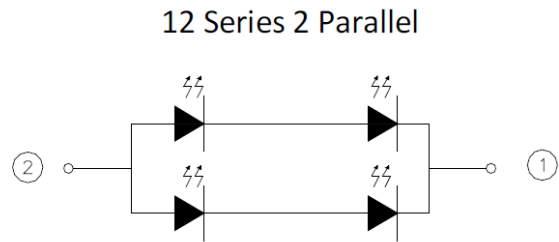
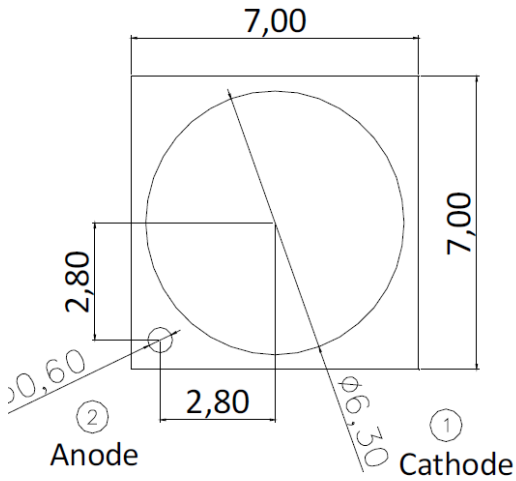
**Package Dimension (mm)**

Polarity

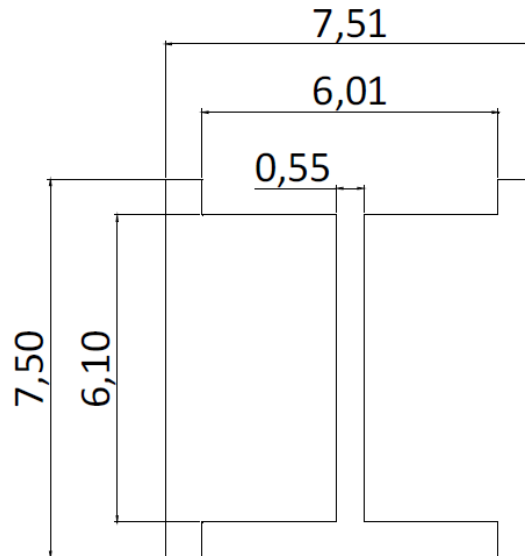
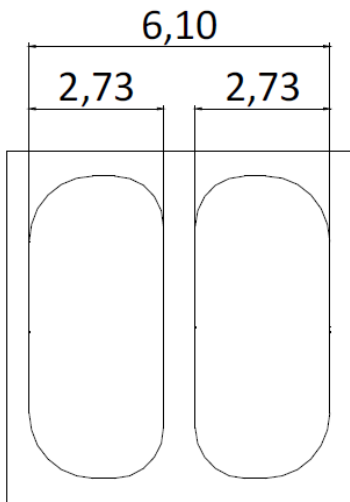
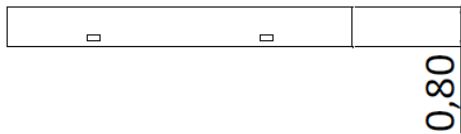

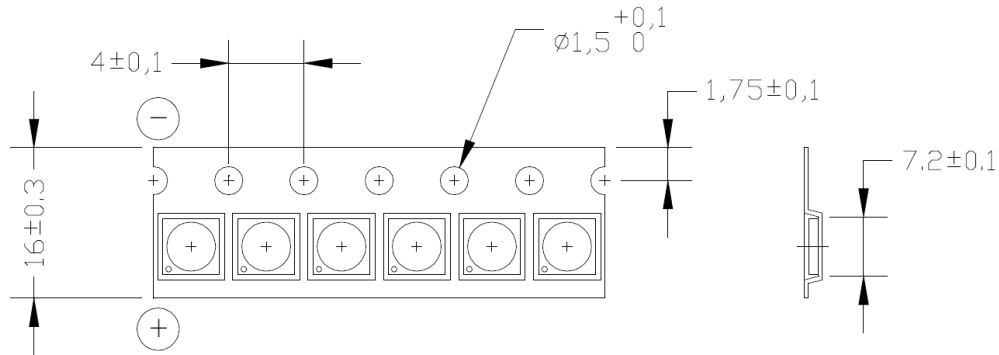
**Package Dimensions Of Type(mm)**

\*Quantity : Max 1000pcs/Reel

\*Cumulative Tolerance : Cumulative Tolerance/10 pitches to be  $\pm 0.2\text{mm}$

\*Adhesion Strength of Cover Tape Adhesion strength to be 0.1-0.7N when the cover tape is turned off from the carrier tape at the angle of  $10^\circ$  to the carrier tape.

\*Package : P/N, Manufacturing data Code No. and Quantity to be indicated on a damp proof Package

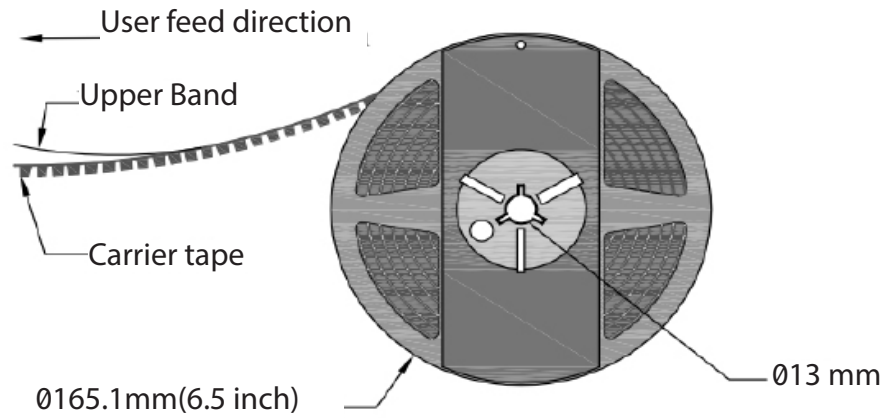
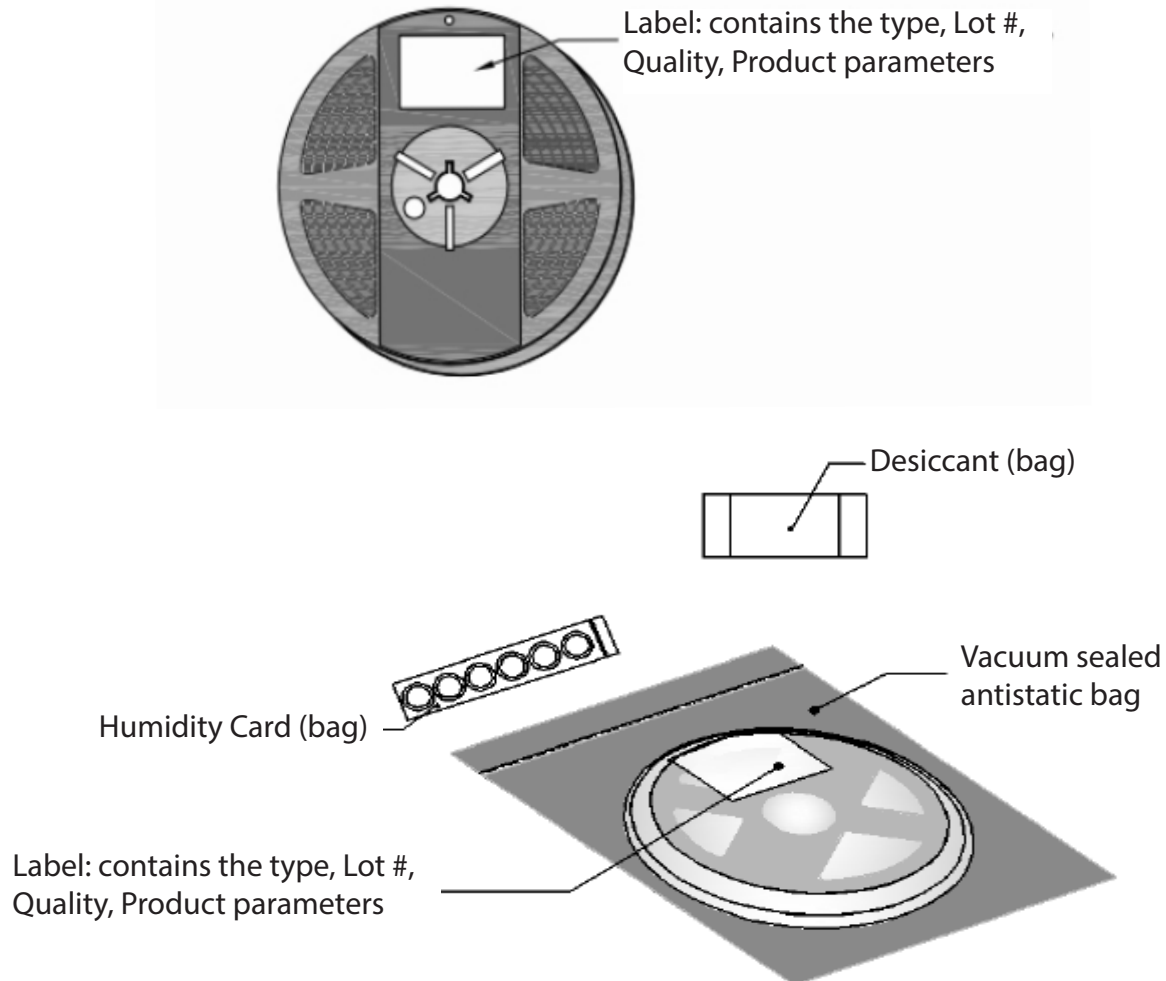
**Package Dimensions of Reel (mm)**

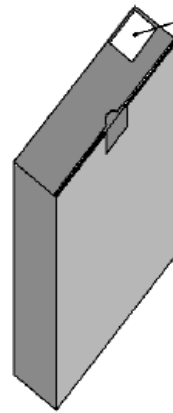
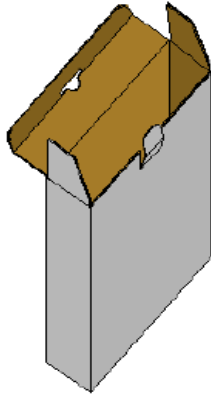
**Package Dimensions of Reel (mm)**

**Inner Box**

Label: contains the type,  
Lot #, Quality, Product  
parameters

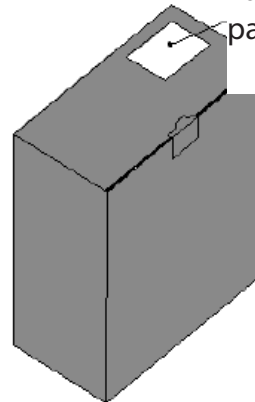
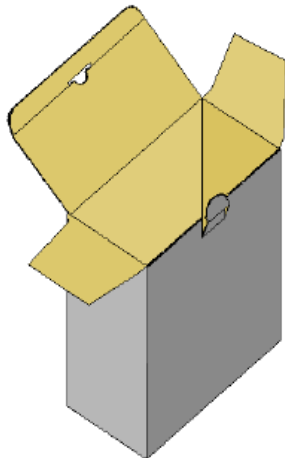
\*Capacity 4 or 8 reels per



Label: contains the type,  
Lot #, Quality, Product  
parameters

\*Capacity 24 or 48 reels per

### Precaution for Use

#### Storage:

1. This device is rated at MSL 3 per JEDEC J-STD-020 standard.
2. Recommended storage condition:  
At 5 °C- 30 °C and relative humidity 60% RH in its original package
3. After this bag is opened, devices that will be applied to infrared reflow, vapor - phase reflow, or equivalent soldering process must be:
  - a) Completed within 168 hours
  - b) Stored at less than 60%RH
  - c) If not completely used within 168 hours, seal the remaining in the moisture barrier bag
4. Devices require baking before mounting, if 3 a) is not met.
5. If baking is required, devices must be baked under below conditions:  
24 hours at 60C+/-5C

#### Static Electricity:

1. The products are sensitive to static electricity, and care should be taken when handling them.
2. Static electricity or surge voltage will damage the LEDs. It is recommended to wear a anti-electrostatic wristband or an anti-electrostatic gloves when handling the LEDs.
3. All devices, equipment and machinery must be properly grounded. It is recommended that measures be taken against surge voltage to the equipment that mounts the LEDs.