

## Data sheet | Item number: 285-607

2-conductor ground terminal block; 35 mm<sup>2</sup>; lateral marker slots; only for DIN 35 x 15 rail; CAGE CLAMP®; 35,00 mm<sup>2</sup>; green-yellow

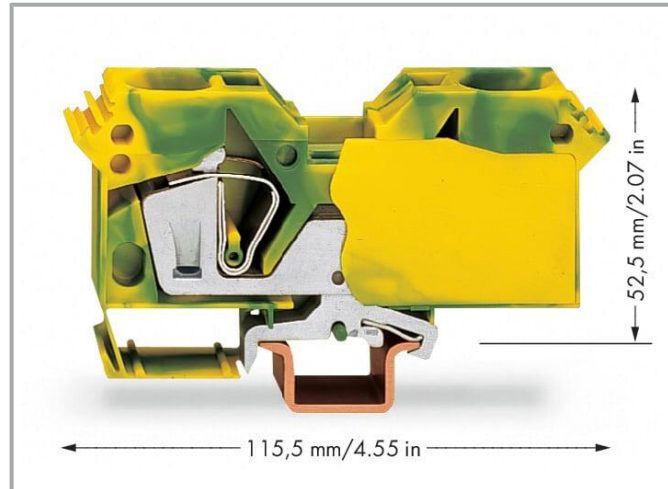

[www.wago.com/285-607](http://www.wago.com/285-607)

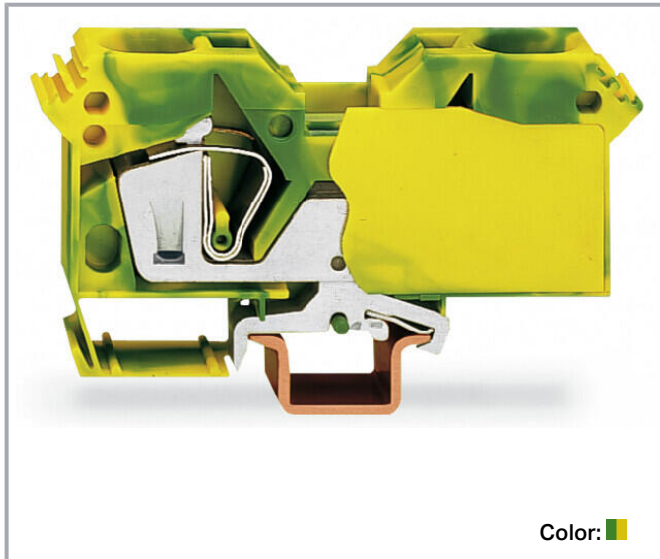

### Data

#### Electrical data

#### Ratings per IEC/EN

Ratings per

IEC/EN 60947-7-2

#### Connection data

Connection points	2
Total number of potentials	1
Number of levels	1

#### Connection 1

Connection technology	CAGE CLAMP®
Actuation type	Operating tool
Connectable conductor materials	Copper
Solid conductor	6 ... 35 mm <sup>2</sup> / 8 ... 2 AWG
Strip length	23 mm / 0.91 inches

Subject to changes. Please also observe the further product documentation!

WAGO GmbH & Co. KG  
Hansastr. 27  
32423 Minden  
Phone: +49571 887-0 | Fax: +49571 887-169  
Email: [info.de@wago.com](mailto:info.de@wago.com) | Web: [www.wago.com](http://www.wago.com)

Do you have any questions about our products?  
We are always happy to take your call at +49 (571) 887-44222.



Wiring direction

Front-entry wiring

## Physical data

Width	16 mm / 0.63 inches
Height	115.5 mm / 4.547 inches
Depth from upper-edge of DIN-rail	52.5 mm / 2.067 inches

## Mechanical Data

Design	horizontal type
Mounting type	DIN-35 rail
Mounting (note)	only suitable for DIN 35 x 15 rail
Marking level	Side marking

## Material Data

Note (material data)

Information on material specifications can be found here

Color	green-yellow
Material group	I
Insulation material	Polyamide (PA66)
Flammability class per UL94	V0
Fire load	1.164 MJ
Weight	152.3 g

## Environmental requirements

Processing temperature	-35 ... +85 °C
Continuous operating temperature	-60 ... +105 °C

## Commercial data

Product Group	1 (Rail Mounted Terminal Blocks)
eCl@ss 10.0	27-14-11-41
eCl@ss 9.0	27-14-11-41
ETIM 8.0	EC000901
ETIM 7.0	EC000901
PU (SPU)	15 pcs
Packaging type	box
Country of origin	DE

Subject to changes. Please also observe the further product documentation!



GTIN	4045454116101
Customs tariff number	85369010000

## Environmental Product Compliance

CAS-No.	7439-92-1
REACH Candidate List Substance	Lead
RoHS Compliance Status	Compliant,With Exemption
RoHS Exemption	7(a) 7(c)-I 7(c)-II
SCIP notification number (Austria)	43f66727-8fda-4b37-a4f5-e2383ea23091
SCIP notification number (Belgium)	aa5de5fe-0629-46f6-b1ee-218e320c4661
SCIP notification number (Bulgaria)	b7ee5704-9f66-4f5d-9d31-13e6d7678f0a
SCIP notification number (Czech Republic)	59d78fbd-1b20-4c47-b4b7-e692246b3084
SCIP notification number (Denmark)	1ee594b5-0717-4d60-a07c-c6458ae14c74
SCIP notification number (Finland)	f3b80ae8-870a-4da6-8998-b8b752e6d8dd
SCIP notification number (France)	388fa84b-d9ef-458e-a382-752d5b01ae24
SCIP notification number (Germany)	efa64b14-e7c5-42cd-8e89-717781b9487c
SCIP notification number (Hungary)	aea97d68-f665-41ac-b7f1-957c37baf3db
SCIP notification number (Italy)	3ac5e124-e11b-4851-a028-3f0e84eb5083
SCIP notification number (Netherlands)	e6db50ad-0c0a-46e4-9a78-7aee52944f91
SCIP notification number (Poland)	930297fc-c815-49bf-b8b9-3f84d393bf7c
SCIP notification number (Romania)	1ced03d2-e2ca-4011-baa4-31a9202c80cb
SCIP notification number (Sweden)	796ab20f-4027-4807-bcbd-f21f5e33b9ee

## Approvals / Certificates

### General approvals



Logo	Approval	Additional Approval Text	Certificate name
	CCA DEKRA Certification B.V.	EN 60947	NTR NL-7707
	CSA DEKRA Certification B.V.	C22.2 No. 158	154112
	KEMA/KEUR DEKRA Certification B.V.	EN 60947	71-105562

Subject to changes. Please also observe the further product documentation!







	UL Underwriters Laboratories Inc.	UL 1059	E45172
--	--------------------------------------	---------	--------

## Declarations of conformity and manufacturer's declarations

Logo	Approval	Additional Approval Text	Certificate name
	EU-Declaration of Conformity WAGO GmbH & Co. KG	-	-
	UK-Declaration of Conformity WAGO GmbH & Co. KG	-	-

## Approvals for marine applications

Logo	Approval	Additional Approval Text	Certificate name
	ABS American Bureau of Shipping	EN 60947	20- HG1941090- PDA
	BV Bureau Veritas S.A.	EN 60947	07436/F0 BV
	DNV GL Det Norske Veritas, Germanischer Lloyd	-	TAE00001V2
	LR Lloyds Register	EN 60947	91/20112 (E9)

## Approvals for hazardous areas

Logo	Approval	Additional Approval Text	Certificate name
------	----------	--------------------------	------------------

Subject to changes. Please also observe the further product documentation!

WAGO GmbH & Co. KG  
 Hansastr. 27  
 32423 Minden  
 Phone: +49571 887-0 | Fax: +49571 887-169  
 Email: [info.de@wago.com](mailto:info.de@wago.com) | Web: [www.wago.com](http://www.wago.com)

Do you have any questions about our products?  
 We are always happy to take your call at +49 (571) 887-44222.



AEx  
Underwriters Laboratories Inc.

E185892  
(AEx eb II  
C resp. Ex  
eb II C)

## Required accessories

### End plate

End plate



**Item no.: 285-327**  
Separator plate; 2 mm thick; oversized; orange

[www.wago.com/285-327](http://www.wago.com/285-327)



**Item no.: 285-337**  
Separator plate; 2 mm thick; oversized; gray

[www.wago.com/285-337](http://www.wago.com/285-337)

## Optional accessories

### Ferrule

Ferrule



**Item no.: 216-108**  
Ferrule; Sleeve for 6 mm<sup>2</sup> / AWG 10; uninsulated; electro-tin plated; silver-colored

[www.wago.com/216-108](http://www.wago.com/216-108)



**Item no.: 216-109**  
Ferrule; Sleeve for 10 mm<sup>2</sup> / AWG 8; uninsulated; electro-tin plated

[www.wago.com/216-109](http://www.wago.com/216-109)



**Item no.: 216-110**  
Ferrule; Sleeve for 16 mm<sup>2</sup> / AWG 6; uninsulated; electro-tin plated; brown metallic

[www.wago.com/216-110](http://www.wago.com/216-110)



**Item no.: 216-209**  
Ferrule; Sleeve for 10 mm<sup>2</sup> / AWG 8; insulated; electro-tin plated; red

[www.wago.com/216-209](http://www.wago.com/216-209)



**Item no.: 216-208**  
Ferrule; Sleeve for 6 mm<sup>2</sup> / AWG 10; insulated; electro-tin plated; electrolytic copper; gastight crimped; acc. to DIN 46228, Part 4/09.90; yellow

[www.wago.com/216-208](http://www.wago.com/216-208)



**Item no.: 216-210**  
Ferrule; Sleeve for 16 mm<sup>2</sup> / AWG 6; insulated; electro-tin plated; electrolytic copper; gastight crimped; acc. to DIN 46228, Part 4/09.90; blue

[www.wago.com/216-210](http://www.wago.com/216-210)



**Item no.: 216-288**  
Ferrule; Sleeve for 6 mm<sup>2</sup> / AWG 10; insulated; electro-tin plated; electrolytic copper; gastight crimped; acc. to DIN 46228, Part 4/09.90; yellow

[www.wago.com/216-288](http://www.wago.com/216-288)



**Item no.: 216-289**  
Ferrule; Sleeve for 10 mm<sup>2</sup> / AWG 8; insulated; electro-tin plated; electrolytic copper; gastight crimped; acc. to DIN 46228, Part 4/09.90; red

[www.wago.com/216-289](http://www.wago.com/216-289)



**Item no.: 216-413**  
Ferrule; Sleeve for 25 mm<sup>2</sup> / AWG 4; uninsulated; electro-tin plated; electrolytic copper; gastight crimped; acc. to DIN 46228, Part 1/08.92; silver-colored

[www.wago.com/216-413](http://www.wago.com/216-413)



**Item no.: 216-414**

Subject to changes. Please also observe the further product documentation!

WAGO GmbH & Co. KG  
Hansastr. 27  
32423 Minden  
Phone: +49571 887-0 | Fax: +49571 887-169  
Email: [info.de@wago.com](mailto:info.de@wago.com) | Web: [www.wago.com](http://www.wago.com)

Do you have any questions about our products?  
We are always happy to take your call at +49 (571) 887-44222.

Ferrule; Sleeve for 35 mm<sup>2</sup> / AWG 2; uninsulated; electro-tin plated; electrolytic copper; gastight crimped; acc. to DIN 46228, Part 1/08.92; silver-colored

[www.wago.com/216-414](http://www.wago.com/216-414)

**Item no.: 216-424**

Ferrule; Sleeve for 35 mm<sup>2</sup> / AWG 2; uninsulated; electro-tin plated; electrolytic copper; gastight crimped; acc. to DIN 46228, Part 1/08.92; silver-colored

[www.wago.com/216-424](http://www.wago.com/216-424)

**Cover**

Cover



**Item no.: 285-400**

Finger guard; touchproof cover protects unused conductor entries; yellow

[www.wago.com/285-400](http://www.wago.com/285-400)

**Carrier rail**

Mounting accessories



**Item no.: 210-197**

Steel carrier rail; 35 x 15 mm; 1.5 mm thick; 2 m long; slotted; similar to EN 60715; silver-colored

[www.wago.com/210-197](http://www.wago.com/210-197)



**Item no.: 210-198**

Copper carrier rail; 35 x 15 mm; 2.3 mm thick; 2 m long; unslotted; according to EN 60715; copper-colored

[www.wago.com/210-198](http://www.wago.com/210-198)

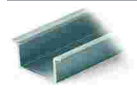

**Item no.: 210-506**

Steel carrier rail; 35 x 15 mm; 1.5 mm thick; 2 m long; unslotted; galvanized; similar to EN 60715; silver-colored

[www.wago.com/210-506](http://www.wago.com/210-506)



**Item no.: 210-508**

Steel carrier rail; 35 x 15 mm; 1.5 mm thick; 2 m long; slotted; galvanized; similar to EN 60715; silver-colored

[www.wago.com/210-508](http://www.wago.com/210-508)

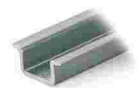

**Item no.: 210-118**

Steel carrier rail; 35 x 15 mm; 2.3 mm thick; 2 m long; unslotted; according to EN 60715; silver-colored

[www.wago.com/210-118](http://www.wago.com/210-118)



**Item no.: 210-114**

Steel carrier rail; 35 x 15 mm; 1.5 mm thick; 2 m long; unslotted; similar to EN 60715; silver-colored

[www.wago.com/210-114](http://www.wago.com/210-114)

**Protective warning marker**

Cover



**Item no.: 285-415**

Protective warning marker; for 5 terminal blocks; with high-voltage symbol, black; yellow

[www.wago.com/285-415](http://www.wago.com/285-415)

**Voltage tap**

Power tap



**Item no.: 283-407**

Power tap; with 500 mm cable; for 16 mm<sup>2</sup> (283/783 Series) and 35 mm<sup>2</sup>; gray

[www.wago.com/283-407](http://www.wago.com/283-407)

**Marking accessories**

Marker

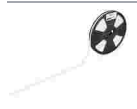

**Item no.: 2009-115/000-002**

WMB-Inline; for Smart Printer; 1500 pieces on roll; stretchable 5 - 5.2 mm; plain; snap-on type; yellow

[www.wago.com/2009-115/000-002](http://www.wago.com/2009-115/000-002)

Subject to changes. Please also observe the further product documentation!

WAGO GmbH & Co. KG

Hansastr. 27











32423 Minden

Phone: +49571 887-0 | Fax: +49571 887-169

Email: [info.de@wago.com](mailto:info.de@wago.com) | Web: [www.wago.com](http://www.wago.com)

Do you have any questions about our products?

We are always happy to take your call at +49 (571) 887-44222.

	<b>Item no.: 2009-115/000-007</b> WMB-Inline; for Smart Printer; 1500 pieces on roll; stretchable 5 - 5.2 mm; plain; snap-on type; gray	<a href="http://www.wago.com/2009-115/000-007">www.wago.com/2009-115/000-007</a>
	<b>Item no.: 2009-115/000-017</b> WMB-Inline; for Smart Printer; 1500 pieces on roll; stretchable 5 - 5.2 mm; plain; snap-on type; light green	<a href="http://www.wago.com/2009-115/000-017">www.wago.com/2009-115/000-017</a>
	<b>Item no.: 2009-115/000-023</b> WMB-Inline; for Smart Printer; 1500 pieces on roll; stretchable 5 - 5.2 mm; plain; snap-on type; green	<a href="http://www.wago.com/2009-115/000-023">www.wago.com/2009-115/000-023</a>
	<b>Item no.: 2009-115/000-024</b> WMB-Inline; for Smart Printer; 1500 pieces on roll; stretchable 5 - 5.2 mm; plain; snap-on type; violet	<a href="http://www.wago.com/2009-115/000-024">www.wago.com/2009-115/000-024</a>
	<b>Item no.: 2009-115</b> WMB-Inline; for Smart Printer; 1500 pieces on roll; stretchable 5 - 5.2 mm; plain; snap-on type; white	<a href="http://www.wago.com/2009-115">www.wago.com/2009-115</a>
	<b>Item no.: 793-5501/000-007</b> WMB marking card; as card; for terminal block width 5 - 17.5 mm; stretchable 5 - 5.2 mm; plain; snap-on type; gray	<a href="http://www.wago.com/793-5501/000-007">www.wago.com/793-5501/000-007</a>
	<b>Item no.: 793-5501/000-012</b> WMB marking card; as card; for terminal block width 5 - 17.5 mm; stretchable 5 - 5.2 mm; plain; snap-on type; orange	<a href="http://www.wago.com/793-5501/000-012">www.wago.com/793-5501/000-012</a>
	<b>Item no.: 793-5501/000-017</b> WMB marking card; as card; for terminal block width 5 - 17.5 mm; stretchable 5 - 5.2 mm; plain; snap-on type; light green	<a href="http://www.wago.com/793-5501/000-017">www.wago.com/793-5501/000-017</a>
	<b>Item no.: 793-5501/000-023</b> WMB marking card; as card; for terminal block width 5 - 17.5 mm; stretchable 5 - 5.2 mm; plain; snap-on type; green	<a href="http://www.wago.com/793-5501/000-023">www.wago.com/793-5501/000-023</a>
	<b>Item no.: 793-5501/000-024</b> WMB marking card; as card; for terminal block width 5 - 17.5 mm; stretchable 5 - 5.2 mm; plain; snap-on type; violet	<a href="http://www.wago.com/793-5501/000-024">www.wago.com/793-5501/000-024</a>
	<b>Item no.: 793-501/000-002</b> WMB marking card; as card; not stretchable; plain; snap-on type; yellow	<a href="http://www.wago.com/793-501/000-002">www.wago.com/793-501/000-002</a>

Subject to changes. Please also observe the further product documentation!



**Item no.: 793-501/000-007**  
WMB marking card; as card; not stretchable; plain; snap-on type; gray

[www.wago.com/793-501/000-007](http://www.wago.com/793-501/000-007)



**Item no.: 793-501/000-017**  
WMB marking card; as card; not stretchable; plain; snap-on type; light green

[www.wago.com/793-501/000-017](http://www.wago.com/793-501/000-017)



**Item no.: 793-501/000-012**  
WMB marking card; as card; not stretchable; plain; snap-on type; orange

[www.wago.com/793-501/000-012](http://www.wago.com/793-501/000-012)



**Item no.: 793-501/000-023**  
WMB marking card; as card; not stretchable; plain; snap-on type; green

[www.wago.com/793-501/000-023](http://www.wago.com/793-501/000-023)



**Item no.: 793-501/000-006**  
WMB marking card; as card; not stretchable; plain; snap-on type; blue

[www.wago.com/793-501/000-006](http://www.wago.com/793-501/000-006)



**Item no.: 793-501/000-005**  
WMB marking card; as card; not stretchable; plain; snap-on type; red

[www.wago.com/793-501/000-005](http://www.wago.com/793-501/000-005)



**Item no.: 793-501**  
WMB marking card; as card; not stretchable; plain; snap-on type; white

[www.wago.com/793-501](http://www.wago.com/793-501)



**Item no.: 793-501/000-024**  
WMB marking card; as card; not stretchable; plain; snap-on type; violet

[www.wago.com/793-501/000-024](http://www.wago.com/793-501/000-024)



**Item no.: 793-5501/000-005**  
WMB marking card; as card; for terminal block width 5 - 17.5 mm; stretchable 5 - 5.2 mm; plain; snap-on type; red

[www.wago.com/793-5501/000-005](http://www.wago.com/793-5501/000-005)



**Item no.: 793-5501/000-002**  
WMB marking card; as card; for terminal block width 5 - 17.5 mm; stretchable 5 - 5.2 mm; plain; snap-on type; yellow

[www.wago.com/793-5501/000-002](http://www.wago.com/793-5501/000-002)

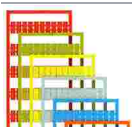









**Item no.: 793-5501/000-006**  
WMB marking card; as card; for terminal block width 5 - 17.5 mm; stretchable 5 - 5.2 mm; plain; snap-on type; blue

[www.wago.com/793-5501/000-006](http://www.wago.com/793-5501/000-006)

Subject to changes. Please also observe the further product documentation!

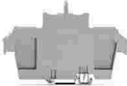

	<b>Item no.: 793-5501</b> WMB marking card; as card; for terminal block width 5 - 17.5 mm; stretchable 5 - 5.2 mm; plain; snap-on type; white	<a href="http://www.wago.com/793-5501">www.wago.com/793-5501</a>
	<b>Item no.: 2009-115/000-012</b> WMB-Inline; for Smart Printer; 1500 pieces on roll; stretchable 5 - 5.2 mm; plain; snap-on type; orange	<a href="http://www.wago.com/2009-115/000-012">www.wago.com/2009-115/000-012</a>
	<b>Item no.: 2009-115/000-006</b> WMB-Inline; for Smart Printer; 1500 pieces on roll; stretchable 5 - 5.2 mm; plain; snap-on type; blue	<a href="http://www.wago.com/2009-115/000-006">www.wago.com/2009-115/000-006</a>
<b>Group marker carrier</b>		
	<b>Item no.: 249-105</b> Group marker carrier; gray	<a href="http://www.wago.com/249-105">www.wago.com/249-105</a>
<b>Tool</b>		
Operating tool		
	<b>Item no.: 210-721</b> Operating tool; Blade: 5.5 x 0.8 mm; with a partially insulated shaft; multicoloured	<a href="http://www.wago.com/210-721">www.wago.com/210-721</a>
<b>Jumpers</b>		
Jumper		
	<b>Item no.: 283-422</b> Jumper; insulated; yellow-green	<a href="http://www.wago.com/283-422">www.wago.com/283-422</a>
	<b>Item no.: 283-402</b> Jumper; insulated; gray	<a href="http://www.wago.com/283-402">www.wago.com/283-402</a>
<b>Mounting</b>		
Cover carrier		
	<b>Item no.: 709-168</b> Cover carrier; Type 2; incl. fixing/retaining screws and knurled nut; suitable for 283 to 285 Series rail-mounted terminal blocks; suitable for 279 to 281 Series double- and triple-deck terminal blocks; suitable for 780 to 785, 775, 776 and 777 Series TOPJOB® rail-mounted terminal blocks; suitable for 280 Series sensor and actuator terminal blocks; suitable for 282 Series disconnect/test terminal blocks for transformer circuits; gray	<a href="http://www.wago.com/709-168">www.wago.com/709-168</a>
Cover		
	<b>Item no.: 709-154</b> Cover; Type 2; suitable for cover carrier, type 2; 1 m long; transparent	<a href="http://www.wago.com/709-154">www.wago.com/709-154</a>
Mounting accessories		
	<b>Item no.: 209-106</b> Mounting carrier; for isolated mounting on DIN 35 rails; gray	<a href="http://www.wago.com/209-106">www.wago.com/209-106</a>

Subject to changes. Please also observe the further product documentation!



Item no.: 249-116

Screwless end stop; 6 mm wide; for DIN-rail 35 x 15 and 35 x 7.5; gray

[www.wago.com/249-116](http://www.wago.com/249-116)

---

## Testing and measuring

### Testing accessories



Item no.: 283-404

Test plug adapter; 11.6 mm wide; for 4 mm Ø test plugs; gray

[www.wago.com/283-404](http://www.wago.com/283-404)

## Downloads

### Documentation

#### Additional Information

Technical Section

pdf

Download

Technical explanations

2.2 MB

## CAD/CAE-Data

### CAD data

2D/3D Models 285-607

URL

Download

### CAE data

EPLAN Data Portal 285-607

URL

Download

WSCAD Universe 285-607

URL

Download

ZUKEN Portal 285-607

URL

Download

## Environmental Product Compliance

### Compliance Search

Environmental Product Compliance 285-607

URL

Download

2-conductor ground terminal block; 35 mm<sup>2</sup>; lateral marker slots; only for DIN 35 x 15 rail; CAGE CLAMP®; 35,00 mm<sup>2</sup>; green-yellow

## Installation Notes

### Installation

Subject to changes. Please also observe the further product documentation!

---

WAGO GmbH & Co. KG

Hansastr. 27

32423 Minden

Phone: +49571 887-0 | Fax: +49571 887-169

Email: [info.de@wago.com](mailto:info.de@wago.com) | Web: [www.wago.com](http://www.wago.com)

Do you have any questions about our products?

We are always happy to take your call at +49 (571) 887-44222.

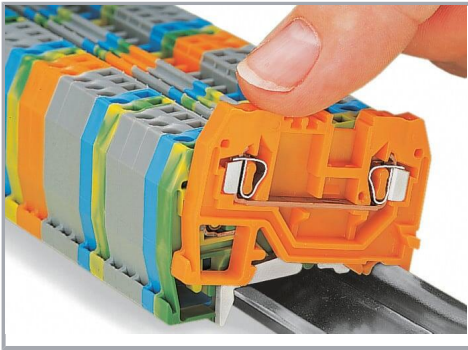

Snapping a terminal block onto the DIN-rail.

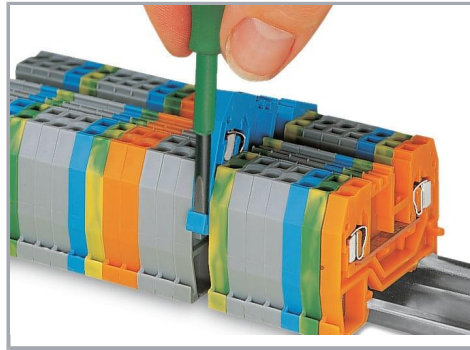

Removing a terminal block from the assembly.



Steel DIN-rails are not suited for PEN (ground and N-conductor) applications per EN 60947-7-2 (VDE 0611, Part 3).

#### Conductor termination

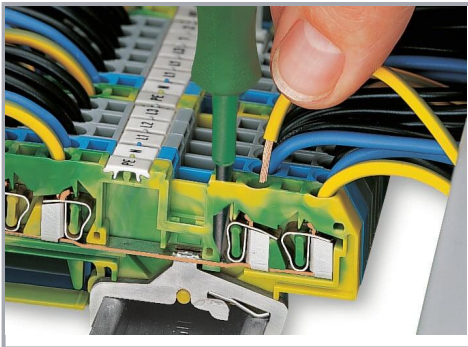

#### CAGE CLAMP® connection

Inserting a conductor.

Subject to changes. Please also observe the further product documentation!

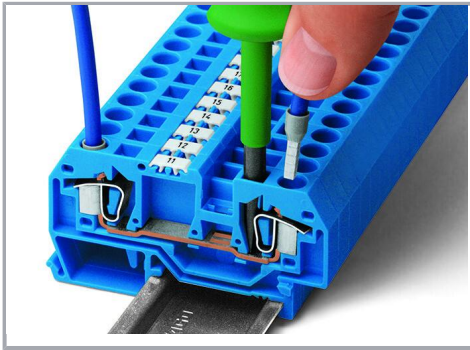

CAGE CLAMP® connection

Inserting a conductor.

With ferruled conductors, it is necessary to use a terminal block one size larger than the conductor's nominal cross-section.

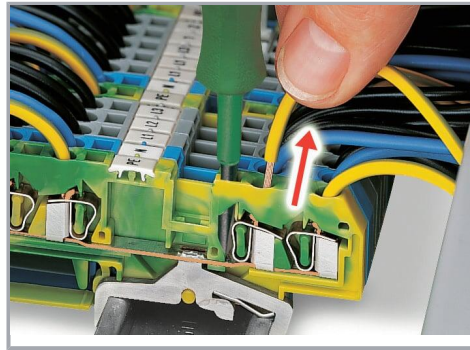

CAGE CLAMP® connection

Removing a solid conductor.

### Commoning

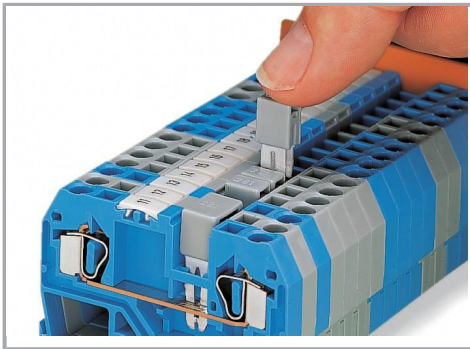

Commoning using an adjacent jumper.

Push jumper down until fully inserted!

### Marking

Subject to changes. Please also observe the further product documentation!

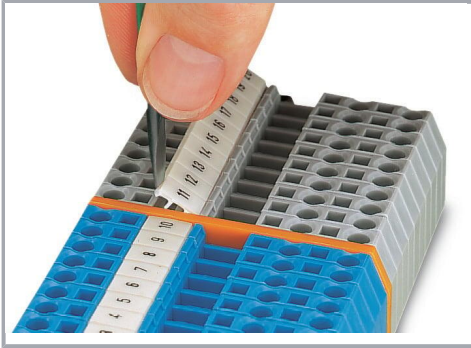

Labeling via WMB Multi Marking System.

## Product family

### Classic

EPSITRON® CLASSIC POWER: The Robust Power Supply – with Integrated TopBoost (Optional)

[Show all products from the family](#)

Subject to changes. Please also observe the further product documentation!