

Color:

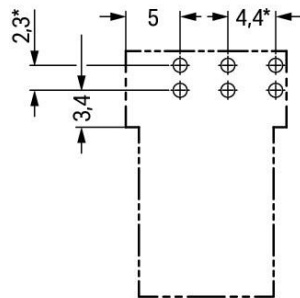
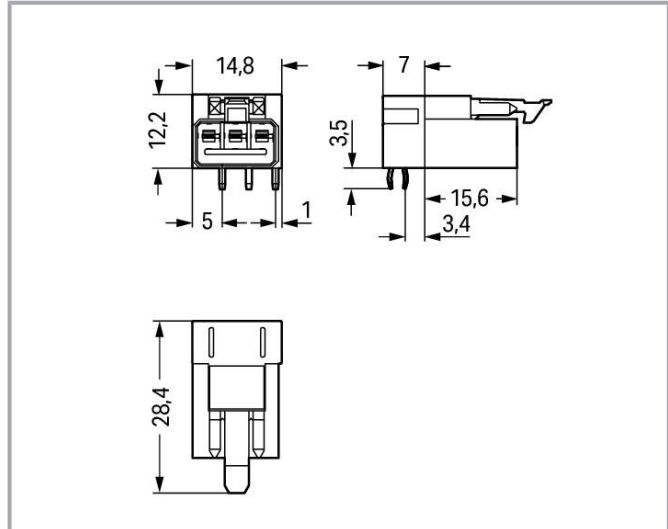

* ± 0.05 mm
Drilled hole diameter: $1.3^{+0.1}$ mm

Item description

Male connector/plug *WINSTA*® MINI with protection against mismatching

The *WINSTA*® MINI male connector/plug 3-pole are compact but powerful PCB terminal blocks. They offer easy operation and the greatest possible Subject to changes. Please also observe the further product documentation!



flexibility for installation. Our immense number of pluggable PCB connectors with various insertion directions and operating variants offers you the right solution for your application at all times. For greater security in electrical installations, the pcb connector is provided with mechanical protection against mismatching. B coding enables the *WINSTA*® MINI pcb connectors to be used for application control in the domains of automation, mechanical engineering and robotics. *WINSTA*® MINI satisfies the demand for miniaturisation. Our smallest pluggable connection system is especially suitable for lights, for instance, since due to LED technology, these offer much less space for the connection technology.

Lower costs through fast commissioning and elimination of service expenses – solutions from *WINSTA*® MINI

WINSTA® is the pluggable connection system that is perfectly tailored to the strict requirements of electrical installation. It offers fast, secure and, above all, error-free installation of components and cables. Take advantage of the pluggable version of our maintenance-free spring pressure connection technology too! Plan your installation with *WINSTA*® MINI pcb connectors with locking lever from WAGO.

- protection against mismatching eliminates errors
- compact design for conductors with a cross-section up to 1.5 mm²
- with B coding for use in automation of processes, such as lighting technology
- quick replacement of defective units during ongoing operation

Data Notes

Variants:

Other pole markings

Other versions (or variants) can be requested from WAGO Sales or configured at <https://configurator.wago.com/>.

Electrical data

Ratings per IEC/EN

Ratings per	IEC/EN 60664-1
Nominal voltage (III/3)	250 V
Rated impulse voltage (III/3)	4 kV
Rated current	16 A
Note (rated current)	13 A for 3-pole load
Legend (ratings)	(III / 3) ≙ Overvoltage category III / Pollution degree 3

Ratings per UL 1977

Note for the US market

Some versions may also be used for current interruption in accordance with the UL certificate in select applications with

Subject to changes. Please also observe the further product documentation!

WAGO GmbH & Co. KG
Hansastr. 27
32423 Minden
Phone: +49571 887-0 | Fax: +49571 887-169
Email: info.de@wago.com | Web: www.wago.com

Do you have any questions about our products?
We are always happy to take your call at +49 (571) 887-44222.



currents below 5 A and voltages up to 600 V. For further information, please contact your local sales office.

Rated voltage (UL 1977)	600 V
Rated current UL 1977	14 A

General

Note on contact resistance	approx. 1 mΩ of contact resistance approx. 0.25 mΩ contact transition plug/socket
----------------------------	--

Connection data

Total number of potentials	3
Number of levels	1

Connection 1

Pole number	3
-------------	---

Physical data

Pin spacing	4.4 mm / 0.173 inches
Width	14.8 mm / 0.583 inches
Height	15.7 mm / 0.618 inches
Height from the surface	12.2 mm / 0.48 inches
Depth	28.4 mm / 1.118 inches
Solder pin length	3.5 mm
Solder pin dimensions	1 x 0.8 mm
Drilled hole diameter with tolerance	1.3 ^(+0.1) mm

Mechanical Data

Application	Control technology
Coding	B
Variable coding	No
Marking	3 2 1
Potential marking	3 2 1
Mating force of a plug-in connection	approx. 20 ... 70 N (depending on pole number)
Retention force of a plug-in connection	Locked: > 80 N
Unmating force of a plug-in connection	Unlocked: approx. 20 ... 70 N (depending on pole number)
Number of mating cycles	200, without resistive load

Subject to changes. Please also observe the further product documentation!

100, with resistive load $I_N = 16$ A, tested (1.5 mm²)

Design	angled
--------	--------

Plug-in connection

Contact type (pluggable connector)	Male connector/plug
Connector (connection type)	for PCB
Mismating protection	Yes
Note on mismating protection	All <i>WINSTA</i> [®] components are 100% protected against mismating when: a.) plugging different numbers of poles b.) plugging while rotated 180 c.) plugging while laterally staggered d.) plugging one pole
Mating direction to the PCB	0°
Locking lever	yes
Locking of plug-in connection	locking lever
Note on locking system	All connectors for mounted installations (snap-in versions for lighting fixtures or devices, all types of PCB and distribution connectors) are factory-equipped with locking levers to ensure plugs and sockets are securely locked. Additional locking levers are only required for flying leads (plug/socket).

PCB contact

PCB contact	THT
Solder pin arrangement	2 in-line solder pins/pole
Number of solder pins per potential	2

Material Data

Note (material data)	Information on material specifications can be found here
Color	light green
Cover color	gray
Material group	I
Insulation material	Polyamide (PA66)
Flammability class per UL94	V0
Clamping spring material	Chrome-nickel spring steel (CrNi)

Subject to changes. Please also observe the further product documentation!

WAGO GmbH & Co. KG
 Hansastr. 27
 32423 Minden
 Phone: +49571 887-0 | Fax: +49571 887-169
 Email: info.de@wago.com | Web: www.wago.com

Do you have any questions about our products?
 We are always happy to take your call at +49 (571) 887-44222.

Contact material	Copper or copper alloy; surface-treated
Contact plating	Tin
Fire load	0.064 MJ
Weight	3.3 g

Environmental requirements

Processing temperature	-5 ... +40 °C
Continuous operating temperature	-35 ... +85 °C
Note on continuous operating temperature	Insulating parts for temperatures ≤ 105 °C

Commercial data



eCl@ss 10.0	27-44-06-05
eCl@ss 9.0	27-44-06-05
ETIM 8.0	EC002560
ETIM 7.0	EC002560
PU (SPU)	100 pcs
Packaging type	box
Country of origin	PL
GTIN	4050821696179
Customs tariff number	85366990990

Environmental Product Compliance

RoHS Compliance Status	Compliant, No Exemption
------------------------	-------------------------

Approvals / Certificates

General approvals

Logo	Approval	Additional Approval Text	Certificate name
	CB DEKRA Certification B.V.	EN 61984	71-112993
	CB DEKRA Certification B.V.	IEC 61984	NL-64351
	cURus Underwriters Laboratories Inc.	UL 1977	E45171

Subject to changes. Please also observe the further product documentation!





KEMA/KEUR
DEKRA Certification B.V.



EN 60320

2148952.04



Declarations of conformity and manufacturer's declarations

Logo	Approval	Additional Approval Text	Certificate name
	EU-Declaration of Conformity WAGO GmbH & Co. KG	-	-
	UK-Declaration of Conformity WAGO GmbH & Co. KG	-	-

Approvals for marine applications

Logo	Approval	Additional Approval Text	Certificate name
	DNV GL Det Norske Veritas, Germanischer Lloyd	-	TAE00001Z6
	LR Lloyds Register	EN 61535	08/20047 (E2)

Counterpart

	Item no.890-263 Socket; 3-pole; Cod. B; 1,50 mm ² ; light green	www.wago.com/890-263
	Item no.891-8993/005-105 pre-assembled interconnecting cable; Socket/plug; 3-pole; Cod. B; 1 m; 1,00 mm ² ; light green	www.wago.com/891-8993/005-105
	Item no.891-8993/105-105 pre-assembled connecting cable; Eca; Socket/open-ended; 3-pole; Cod. B; 1 m; 1,00 mm ² ; light green	www.wago.com/891-8993/105-105

Downloads

CAD/CAE-Data

PCB Design

Subject to changes. Please also observe the further product documentation!

WAGO GmbH & Co. KG
Hansastr. 27
32423 Minden
Phone: +49571 887-0 | Fax: +49571 887-169
Email: info.de@wago.com | Web: www.wago.com

Do you have any questions about our products?
We are always happy to take your call at +49 (571) 887-44222.



[URL](#)

[Download](#)

Symbol and Footprint 890-873/011-000

CAX data for your PCB design, consisting of "schematic symbols and PCB footprints", allow easy integration of the WAGO component into your development environment.

Supported formats:

- Accel EDA 14 & 15
- Altium 6 to current version
- Cadence Allegro
- DesignSpark
- Eagle Libraries
- KiCad
- Mentor Graphics BoardStation
- Mentor Graphics Design Architect
- Mentor Graphics Design Expedition 99 and 2000
- OrCAD 9.X PCB and Capture
- PADS PowerPCB 3, 3.5, 4.X, and 5.X
- PADS PowerPCB and PowerLogic 3.0
- PCAD 2000, 2001, 2002, 2004, and 2006
- Pulsonix 8.5 or newer
- STL
- 3D STEP
- TARGET 3001!
- View Logic ViewDraw
- Quadcept
- Zuken CadStar 3 and 4
- Zuken CR-5000 and CR-8000

PCB Component Libraries (EDA), PCB CAD Library Ultra Librarian

CAE data

ZUKEN Portal 890-873/011-000

[URL](#)

[Download](#)

CAD data

2D/3D Models 890-873/011-000

[URL](#)

[Download](#)

Environmental Product Compliance

Compliance Search

Subject to changes. Please also observe the further product documentation!

WAGO GmbH & Co. KG
Hansastr. 27
32423 Minden
Phone: +49571 887-0 | Fax: +49571 887-169
Email: info.de@wago.com | Web: www.wago.com

Do you have any questions about our products?
We are always happy to take your call at +49 (571) 887-44222.



Environmental Product Compliance 890-873/011-000

URL

Download

Plug for PCBs; angled; 3-pole; Cod. B; light green

Installation Notes

Product family

WINSTA® MINI

[Show all products from the family](#)

Subject to changes. Please also observe the further product documentation!

WAGO GmbH & Co. KG

Hansastr. 27

32423 Minden

Phone: +49571 887-0 | Fax: +49571 887-169

Email: info.de@wago.com | Web: www.wago.com

Do you have any questions about our products?

We are always happy to take your call at +49 (571) 887-44222.