



LED Module

REV.NO.

PAGE

0.1

1/11

SPECIFICATION

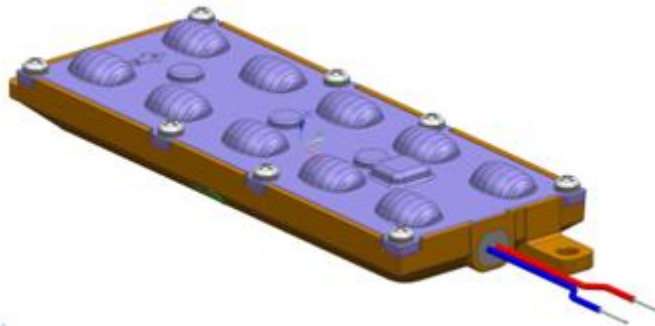

LED Module for Modular Platform Series

Model Name	LED Platform Module without Fin
Type	CRI min. 70, 4000K, Flux Rank 3, Type II-M, 351B PKG
Parts No.	SL-P7T2F32MBKI

SAMSUNG				CUSTOMER
DEVELOP.	PRODUCT PLANNING	QA(DQA)	SALES	

SAMSUNG ELECTRONICS CO., LTD.



LED Module

REV.NO.	PAGE
0.1	3/11

CONTENTS OF SPECIFICATION

1. APPLICATION	4
2. FUNDAMENTAL SPECIFICATIONS OF MODULE	6
3. PARTS SPECIFICATIONS	7
4. APPEARANCE AND STRUCTURE	8
5. PACKING SPECIFICATION	9
6. Label Structure	10

This is a product specification of [SL-P7T2F32MBKI](#), one of [SL-Puv2vwaabcc](#).
Please refer to relevant [General and Special Application Notes](#) for thermal, optical, electrical, mechanical design and reliability information.



LED Module

REV.NO.

PAGE

0.1

4/11

1. APPLICATION

25W Platform LED Module is designed as a core component in **Modular Platform Engine Series** for street light and flood light application. This document especially specifies **25W Platform LED Module with Fin**, generally recommended for luminaires with insufficient thermal management by the fixture itself.

1-1 Modular Platform Modules.

There are three different types of heat sink designs for 25W Platform LED Module, intended for thermal management either by engine or by fixture.

This document especially specifies **25W Platform LED Module without Fin for thermal management by Fixtures**.



(a) Module with Fin

[Thermal management by Module/Engine]



(b) Module without Fin

[Thermal management by Fixture]

1-2 Modular Platform Engine Series

Typical operating current for one module is set at 700mA, which allows lumen output increment by **2000lm(nominal value)** depending on the number of LED modules.

1-2-1 Lumen Packages with LED Driver

Power Consumption (Engine, Nominal)	Modules (ea)	Driver Output Channels (ea)	Operating Current (mA)	Lumen Output (lm)
25W	1	1	700	2000
50W	2	1	700	4000
75W	3	1	700	6000
100W	4	2	700	8000
150W	6	2	700	12000

※ This Module is recommended using a Isolated PSU.

1-2-2 Current Distribution across Modules

Current per module can vary depending on the Vf distribution of modules in parallel, deviating from the nominal operating current(700mA). The Vf distribution of modules is tightly controlled to achieve uniform driving currents.



LED Module

REV.NO.

PAGE

0.1

5/11

1-2-3 Optic Solutions

Application	Light Distribution	Solutions	Material
Street Light	IESNA Type I	Medium(1)	PC
	IESNA Type II	Short(1), Medium(1), Medium(2)	PC
	IESNA Type III	Medium(1)	PC
	IESNA Type IV	Medium(1)	PC
	IESNA Type V	Short(1)	PC
Flood Light	Medium	Batwing (BA85)	PC

※ BA : Beam Angle, PC : Polycarbonate



LED Module

REV.NO.

PAGE

0.1

6/11

2. FUNDAMENTAL SPECIFICATIONS OF MODULE

No.	ARTICLE	SPECIFICATIONS						
Photometric Specification of Platform LED Module @700mA(stabilized at Tc~65°C)								
	CCT	Article	Symbol	MIN	TYP	MAX	Unit	Equipments
4000K		Luminous Flux	LF	1950	2100	-	lm	Goniometer
		Color Temperature	CCT	3740	3900	4140	K	Integrating Sphere
		Color Consistency	Step	-	3	-	MacAdam Step	Integrating Sphere
		Color Rendering Index	CRI	70	-	-	Ra	Integrating Sphere

※ Typical values are not necessarily the same as the nominal values.

※ Measurement tolerance of luminous flux becomes ± 7% in the value, and the measurement tolerance of the color coordinates is ± 0.005.

2-1

Light Distribution Profile : Type II Medium(1) with Optimized Illuminance Uniformity

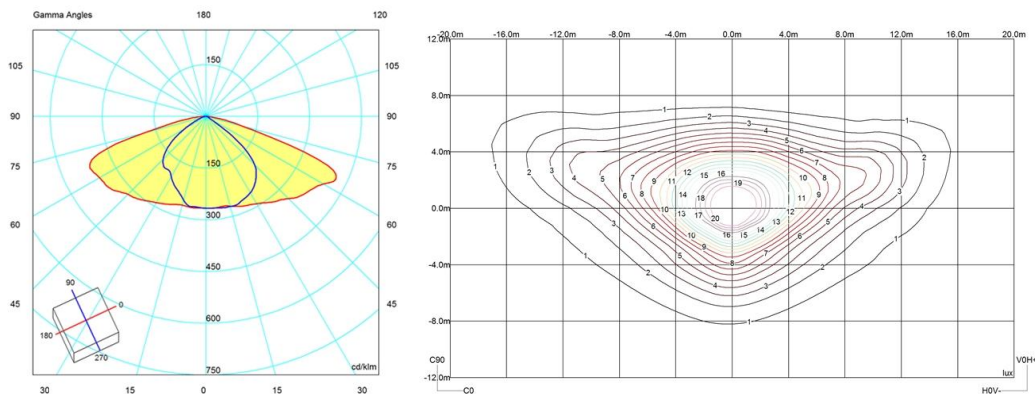

※ The isolux diagram is drawn at the luminaire height of 5m.

※ IES files(in IESNA or CIE format) are available with [Optical Application Notes](#).

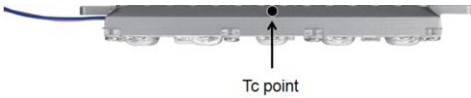
2-2	Dimension	<ul style="list-style-type: none"> LED Module without Fin : 150(L)×50(W)×11.6(H) mm
2-3	Weight	<ul style="list-style-type: none"> LED Lighting Module : {0.17kg ± 0.02kg} * 24ea Total Weight (including packing box) : 5.4kg ± 0.6kg/1box
2-4	Operating Temperature	<ul style="list-style-type: none"> Case Temperature Tc : +10°C ~ +90°C  <p>Tc point</p> <ul style="list-style-type: none"> ※ Recommended Tc points as a function of number of modules are described in Thermal Application Notes. ※ Tc should be measured with recommended Heatshik.
2-5	Storage Temperature	<ul style="list-style-type: none"> -30°C ~ +70°C (Tc) ※ Ambient temperature without operation
2-6	Dust-proof Water-proof	<ul style="list-style-type: none"> IP66 for CE Marking Damp Location for UL Marking



LED Module

REV.NO.

PAGE

0.1

7/11

No.	ARTICLE	SPECIFICATIONS					
2-7	Electrical Specification of Platform LED Module (stabilized at Tc~65℃)						
	Article	Symbol	MIN	TYP	MAX	Unit	Remarks
	Power Consumption	P	-	21	25	W	30V x 0.7A, module only
	Operating Current	Iop	-	700	700	mA	per 1 Module [700mA /PKG 1EA,TYP.]
	Operating Voltage	Vdc	26.0	30	33.0	V	per 1 Module [3.0V/PKG 1EA, TYP.] 10 LEDs in Series
	Type Classification	<ul style="list-style-type: none"> Built-in module  					
	Eye Protection	<ul style="list-style-type: none"> Risk Group 2 					
Working Voltage for Insulation	<ul style="list-style-type: none"> 50V 						
<p>※ The power consumption for a specific module is dependent on the operating voltage distribution across the modules in parallel connection. The maximum operating current means the highest limit in any operating condition.</p> <p>※ Typical and Maximum Operating Current may have ±5%, and Tolerance and measurement tolerance of Vf becomes ± 0.3V in the value</p> <p>※ Voltage difference between modules are tightly controlled to be less than 1.0V so that the maximum current of any module can be limited to 700mA. Voltage bins of modules will be designated on the module label and box label.</p> <p>※ Safety and wiring information will be described in Electrical Application Notes.</p> <p>※ We recommend users to attach the surge protector to a PSU or to use a PSU that equipped surge protect circuit suitable for the user's atmosphere condition.</p>							

3. PARTS SPECIFICATIONS



No.	ARTICLE	SPECIFICATIONS
3-1	Lens Cover Screw	<ul style="list-style-type: none"> Material : Stainless Steel with Teflon Washer Location : between the array lens and heat sink
3-2	Array Lens Cover	<ul style="list-style-type: none"> Material : Polycarbonate Thickness : 2.0 mm Lens Type : Type II-M(1) UL-94 Flammability : V-2 ※ Protective Equipment in Luminaries needs to prevent flaming drips.
3-3	Seal Rubber	<ul style="list-style-type: none"> Material : Molded Silicone
3-4	LED Board	<ul style="list-style-type: none"> LED : Ceramic PKG, CCT 4000K, CRI min. 70 Material : MCPCB, Aluminum Thickness : 1.6 mm Stainless Steel Screws : 3ea
3-5	Side Inlet Harness	<ul style="list-style-type: none"> Material : Molded PVC coated with Sealant Silicone, 105℃ rating Wires : 24 AWG, 105℃ rating Length(wires) : 550 mm
3-6	Heat Sink (without Fin)	<ul style="list-style-type: none"> Material : Die-cast Aluminium Thermal Pad between the PCB and Heat Sink



LED Module

REV.NO.	PAGE
0.1	8/11

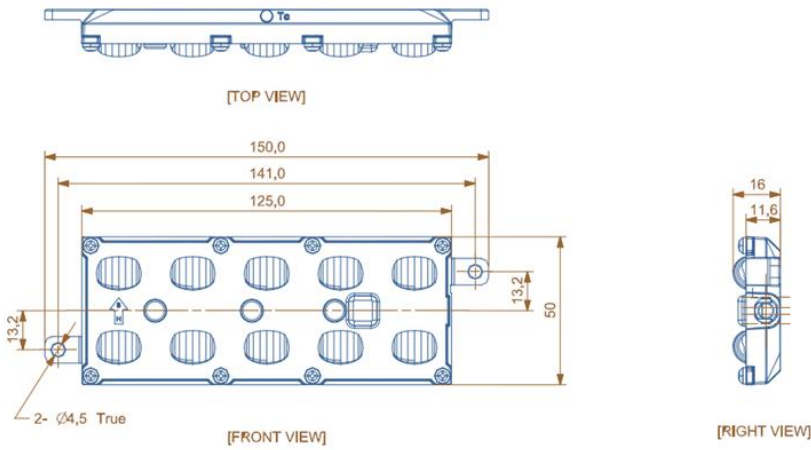
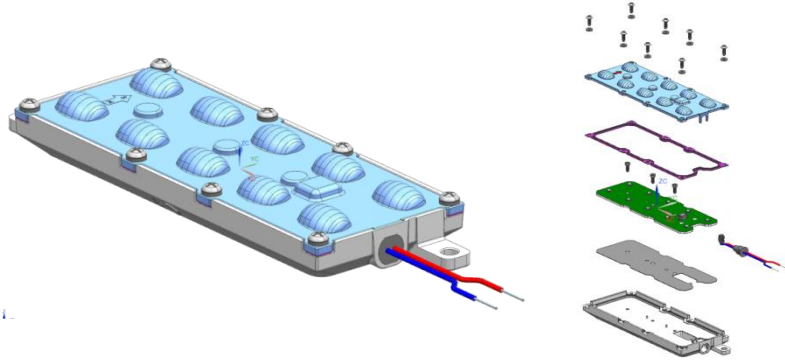
4. APPEARANCE AND STRUCTURE

No.	ARTICLE	SPECIFICATIONS
4-1	<p>Appearance and Dimension (Type II-M(1))</p>	 <p>※ Appearance is different for various optical solutions depending on the combination of the 10 core lenses. Critical dimensions are all the same for the optical solutions except for the thickness difference at the core lens cross-section. Detailed information on the lenses are described in Optical and Mechanical Application Notes.</p>
4-2	<p>Structure (Type II-M(1))</p>	
4-3	<p>Labelling for Vf Binning (General)</p>	 <p>[LED Board Label] [Module Label] [Box Label]</p>



LED Module

REV.NO.

PAGE

0.1

9/11

5. PACKING SPECIFICATION

5-1 Packing Method

5-1-1 Inner Box : 12 modules of the same Vf bin in one inner box

12 PCs/Inner Box



5-1-2 Outer Box : 24 modules on 2 stacks of inner boxes in one outer box

2 Stacks of Inner Boxes
(419 x 240 x 189)



5-2 Pallet : 32 boxes(768 modules) on one pallet

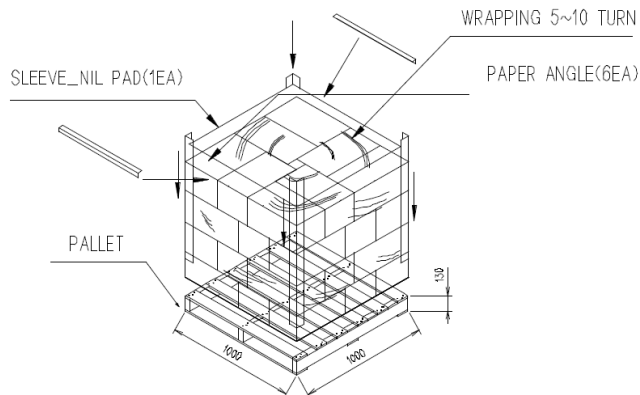

※ Two stacks of pallets are allowed.



LED Module

REV.NO.	PAGE
0.1	10/11

6. LABEL Structure

6-1 LED Board Label

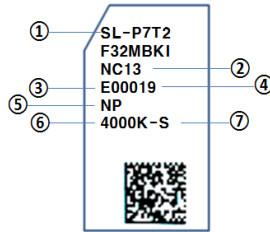

Number	Item	Description
①	Model Number (Product Code)	-
②	SMT Date Code	year: A:00, B:01,.....H:07, I:08,..... month: 1,2,3,4,5,6,7,8,9,A,B,C day:01,02,03,04,05,.....31
③	SMT Line	-
④	Serial Number	00001 ~ 99999
⑤	LED Binning Code	-
⑥	CCT	3000K / 4000 K / 5000 K
⑦	LED Maker	S: Samsung

6-2 Module Label

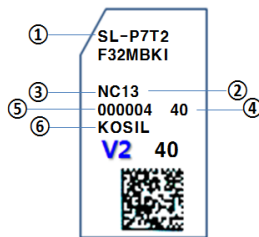

Number	Item	Description
①	Model Number (Product Code)	-
②	Production Date Code	year: A:00, B:01,.....H:07, I:08,..... month: 1,2,3,4,5,6,7,8,9,A,B,C day:01,02,03,04,05,.....31
③	Serial Number	00001 ~ 99999-
④	CCT	3000K / 4000K / 5000K
⑤	Manufacturing Location	KO (Country / Korea) + SIL (Factory)
⑥	Vf Binning Code	-



LED Module

REV.NO.

PAGE

0.1

11/11

6-3 Outer Box Label



Number	Item	Description
①	Model Number (Product Code)	-
②	Lot No.	Factory Code (2) + Production Date (4) + Serial No. (4)
③	Country of Origin	KOREA
④	Packing Quantity	24 pc
⑤	Production Date (year/week#)	yyww
⑥	Label Printing Date (year/month/date)	yy/mm/dd