

Data sheet | Item number: 890-125

Socket; with strain relief housing; 5-pole; Cod. A; 1,50 mm²; white

www.wago.com/890-125

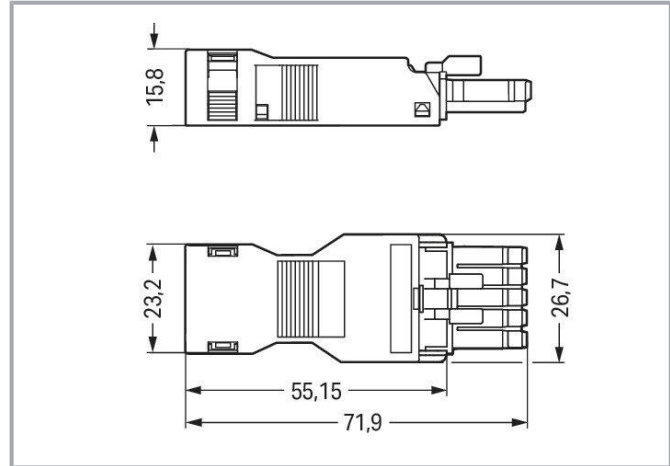
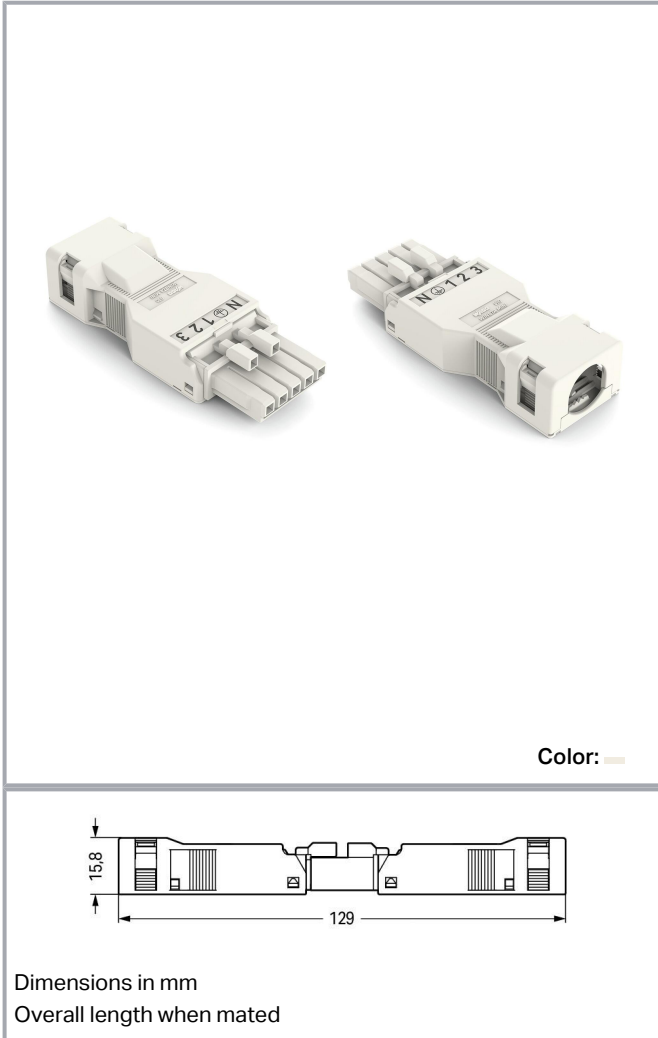

Item description

Female connector/socket WINSTA® MINI with protection type IP40

The WINSTA® MINI female connector/socket A coding is the pluggable solution for your application in control cabinets, on PCBs or for lighting connections. Our pluggable installation connectors with spring pressure connection technology function completely without screw connections.

Subject to changes. Please also observe the further product documentation!

WAGO GmbH & Co. KG
Hansastr. 27
32423 Minden
Phone: +49571 887-0 | Fax: +49571 887-169
Email: info.de@wago.com | Web: www.wago.com

Do you have any questions about our products?
We are always happy to take your call at +49 (571) 887-44222.



They allow fast, efficient, error-free installation in a large number of applications. The coding options reduce installation errors, allowing fast, secure wiring of all components. The pluggable installation connector is protected against ingress by solid granular objects with a diameter of less than 1 mm in accordance with protection type IP40. Standard mains applications for almost any domain of use can be realised with *WINSTA*® MINI pluggable installation connectors with A coding. If only limited space is available, our smallest pluggable connection system, *WINSTA*® MINI, consistently displays its advantageous properties. It is very compact, and, thanks to Push-in CAGE CLAMP® spring pressure connection technology, it also saves time, since the connection is low-maintenance and requires no screw connections. The strip length is 45 mm.

Lower costs through fast commissioning and elimination of service expenses – solutions from *WINSTA*® MINI

The *WINSTA*® Pluggable Connection System allows pluggable electrical installation. This saves time, lowers costs, and reduces the need for servicing. Choose quality and durability – the *WINSTA*® MINI pluggable installation connector with protection against mismatching from WAGO makes the electrical installation of electrical components significantly easier.

- pluggable installation connectors with protection against mismatching
- easy tool-free operation, a wide range of coding options
- with A coding for a large number of applications
- ready for immediate use
- convenient installation and commissioning

Data

Electrical data

Ratings per IEC/EN

Ratings per	IEC/EN 60664-1
Nominal voltage (III/3)	400 V
Rated impulse voltage (III/3)	6 kV
Rated current	13 A
Legend (ratings)	(III / 3) ≙ Overvoltage category III / Pollution degree 3

Ratings per UL 1977

Note for the US market	Some versions may also be used for current interruption in accordance with the UL certificate in select applications with currents below 5 A and voltages up to 600 V. For further information, please contact your local sales office.
Rated voltage (UL 1977)	600 V
Rated current UL 1977	12 A

Subject to changes. Please also observe the further product documentation!



General

Note on contact resistance	approx. 1 mΩ of contact resistance approx. 0.25 mΩ contact transition plug/socket
----------------------------	--

Connection data

Connection points	5
Total number of potentials	5

Connection 1

Connection technology	Push-in CAGE CLAMP®
Actuation type	Operating tool Push-in
Nominal cross-section	1.5 mm ² / 16 AWG
Solid conductor	0.25 ... 1.5 mm ² / 22 ... 16 AWG
Solid conductor; push-in termination	0.75 ... 1.5 mm ² / 20 ... 16 AWG
Stranded conductor	0.25 ... 1 mm ² / 22 ... 18 AWG
Fine-stranded conductor	0.25 ... 1.5 mm ² / 22 ... 16 AWG
Fine-stranded conductor; with insulated ferrule	0.25 ... 0.75 mm ² / 22 ... 20 AWG
Fine-stranded conductor; with uninsulated ferrule	0.25 ... 0.75 mm ² / 22 ... 20 AWG
Fine-stranded conductor; with ferrule; push-in termination	0.75 mm ² / 20 AWG
Strip length	9 mm / 0.35 inches
Pole number	5
Conductor entry direction to mating direction	0°
Strip length (outer insulation)	45 mm

Physical data

Pin spacing	4.4 mm / 0.173 inches
Width	26.7 mm / 1.051 inches
Height	15.8 mm / 0.622 inches
Depth	71.9 mm / 2.831 inches

Mechanical Data

Application	General mains applications
Coding	A
Variable coding	No
Marking	N $\frac{1}{3}$ 1 2 3

Subject to changes. Please also observe the further product documentation!

WAGO GmbH & Co. KG
Hansastr. 27
32423 Minden
Phone: +49571 887-0 | Fax: +49571 887-169
Email: info.de@wago.com | Web: www.wago.com

Do you have any questions about our products?
We are always happy to take your call at +49 (571) 887-44222.



Potential marking	N $\frac{1}{2}$ 1 2 3
Mating force of a plug-in connection	approx. 20 ... 70 N (depending on pole number)
Retention force of a plug-in connection	Locked: > 80 N
Unmating force of a plug-in connection	Unlocked: approx. 20 ... 70 N (depending on pole number)
Number of mating cycles	200, without resistive load
Protection type	IP40

Plug-in connection

Contact type (pluggable connector)	Female connector/socket
Connector (connection type)	for conductor
Mismating protection	Yes
Note on mismating protection	All <i>WINSTA</i> [®] components are 100% protected against mismating when: a.) plugging different numbers of poles b.) plugging while rotated 180 c.) plugging while laterally staggered d.) plugging one pole
Locking lever	Can be retrofitted
Locking of plug-in connection	locking lever
Note on locking system	All connectors for mounted installations (snap-in versions for lighting fixtures or devices, all types of PCB and distribution connectors) are factory-equipped with locking levers to ensure plugs and sockets are securely locked. Additional locking levers are only required for flying leads (plug/socket).
Strain relief	strain relief housing

Material Data

Note (material data)	Information on material specifications can be found here
Color	white
Cover color	gray
Material group	I
Insulation material	Polyamide (PA66)
Flammability class per UL94	V0
Clamping spring material	Chrome-nickel spring steel (CrNi)
Contact material	Copper or copper alloy; surface-treated
Contact plating	Tin
Fire load	0.344 MJ

Subject to changes. Please also observe the further product documentation!

Weight	12 g
--------	------

Environmental requirements

Processing temperature	-5 ... +40 °C
Continuous operating temperature	-35 ... +85 °C
Note on continuous operating temperature	Insulating parts for temperatures ≤ 105 °C

Commercial data



Product Group	20 (Winsta)
eCl@ss 10.0	27-44-06-05
eCl@ss 9.0	27-44-06-05
ETIM 8.0	EC002560
ETIM 7.0	EC002560
PU (SPU)	50 pcs
Packaging type	box
Country of origin	DE
GTIN	4045454232986
Customs tariff number	85366990990

Environmental Product Compliance

RoHS Compliance Status	Compliant, No Exemption
------------------------	-------------------------

Approvals / Certificates

General approvals

Logo	Approval	Additional Approval Text	Certificate name
	CCA DEKRA Certification B.V.	EN 61535	71- 123231
	CCA DEKRA Certification B.V.	IEC 61535	NL-85020
	cURus Underwriters Laboratories Inc.	UL 1977	E45171



Declarations of conformity and manufacturer's declarations

Certificate



Subject to changes. Please also observe the further product documentation!

WAGO GmbH & Co. KG
 Hansastr. 27
 32423 Minden
 Phone: +49571 887-0 | Fax: +49571 887-169
 Email: info.de@wago.com | Web: www.wago.com





Do you have any questions about our products?
 We are always happy to take your call at +49 (571) 887-44222.

Logo	Approval	Additional Approval Text	name
	EU-Declaration of Conformity WAGO GmbH & Co. KG	-	-
	UK-Declaration of Conformity WAGO GmbH & Co. KG	-	-

Approvals for marine applications

Logo	Approval	Additional Approval Text	Certificate name
	ABS American Bureau of Shipping	Steel Vessel Rules	19- HG1869855- PDA
	DNV GL Det Norske Veritas, Germanischer Lloyd	-	TAE00001Z6
	LR Lloyds Register	EN 61535	08/20047 (E2)





Counterpart

	Item no.890-235 Plug; 5-pole; Cod. A; 1,50 mm ² ; white	www.wago.com/890-235
	Item no.890-135 Plug; with strain relief housing; 5-pole; 1,50 mm ² ; white	www.wago.com/890-135
	Item no.890-671 T-distribution connector; 5-pole; Cod. A; 1 input; 2 outputs; 2 locking levers; white	www.wago.com/890-671
	Item no.890-672 T-distribution connector; 5-pole; Cod. A; 1 input; 2 outputs; 3 locking levers; for flying leads; white	www.wago.com/890-672
	Item no.890-735 Snap-in plug; 5-pole; Cod. A; 1,50 mm ² ; white	www.wago.com/890-735

Subject to changes. Please also observe the further product documentation!

WAGO GmbH & Co. KG
Hansastr. 27
32423 Minden
Phone: +49571 887-0 | Fax: +49571 887-169
Email: info.de@wago.com | Web: www.wago.com



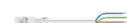

Do you have any questions about our products?
We are always happy to take your call at +49 (571) 887-44222.

	Item no.890-835 Plug for PCBs; straight; 5-pole; Cod. A; white	www.wago.com/890-835
	Item no.890-835/011-000 Plug for PCBs; angled; 5-pole; Cod. A; white	www.wago.com/890-835/011-000
	Item no.890-979 h-distribution connector; 5-pole; Cod. A; 1 input; 2 outputs; outputs on one side; 2 locking levers; white	www.wago.com/890-979
	Item no.890-980 h-distribution connector; 5-pole; Cod. A; 1 input; 2 outputs; outputs on one side; 3 locking levers; for flying leads; white	www.wago.com/890-980
	Item no.891-8995/006-102 pre-assembled interconnecting cable; Eca; Socket/plug; 5-pole; Cod. A; H05VV-F 5G 1.5 mm ² ; 1 m; 1,50 mm ² ; white	www.wago.com/891-8995/006-102
	Item no.891-8995/206-102 pre-assembled connecting cable; Eca; Plug/open-ended; 5-pole; Cod. A; H05VV-F 5G 1.5 mm ² ; 1 m; 1,50 mm ² ; white	www.wago.com/891-8995/206-102

Required accessories

Locking levers

Locking system

	Item no.: 890-111 Locking lever; for flying leads; for tool operation; black	www.wago.com/890-111
	Item no.: 890-101 Locking lever; for manual operation; black	www.wago.com/890-101
	Item no.: 890-121 Locking lever; for manual operation; white	www.wago.com/890-121
	Item no.: 890-131 Locking lever; for flying leads; for tool operation; white	www.wago.com/890-131

Optional accessories

Cover

Cover

Subject to changes. Please also observe the further product documentation!



Item no.: 897-2003

Protective cap; Type2; for sockets and plugs; PVC; red

www.wago.com/897-2003

Tool

Operating tool



Item no.: 210-719

Operating tool; Blade: 2.5 x 0.4 mm; with a partially insulated shaft

www.wago.com/210-719



Item no.: 890-385

Operating tool; 5-way; green

www.wago.com/890-385

Mounting

Mounting accessories



Item no.: 890-310

Mounting carrier; 2- to 5-pole; for flying leads; black

www.wago.com/890-310



Item no.: 890-311

Mounting carrier; 2- to 5-pole; for flying leads; white

www.wago.com/890-311

Shield termination

Shield termination



Item no.: 890-526

Shield connecting plate; 5-pole; for sockets

www.wago.com/890-526

Downloads

Documentation

Bid Text

890-125 X81 - Datei	2019 Feb 19	xml 3.1 kB	Download
890-125 doc - Datei	2015 Jun 8	doc 24.1 kB	Download

CAD/CAE-Data

CAD data

2D/3D Models 890-125

Subject to changes. Please also observe the further product documentation!

WAGO GmbH & Co. KG

Hansastr. 27

32423 Minden

Phone: +49571 887-0 | Fax: +49571 887-169

Email: info.de@wago.com | Web: www.wago.com

Do you have any questions about our products?

We are always happy to take your call at +49 (571) 887-44222.

[URL](#) [Download](#)

CAE data

WSCAD Universe 890-125

[URL](#) [Download](#)

ZUKEN Portal 890-125

[URL](#) [Download](#)

Environmental Product Compliance

Compliance Search

Environmental Product Compliance 890-125

[URL](#) [Download](#)

Socket; with strain relief housing; 5-pole; Cod. A; 1,50 mm²; white

Installation Notes

Conductor termination

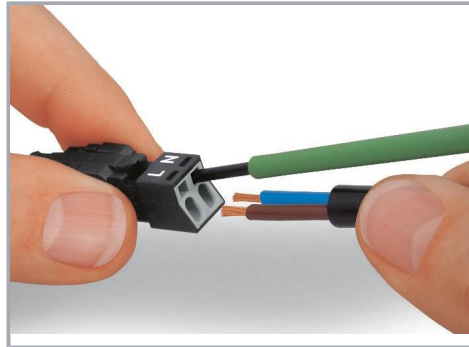
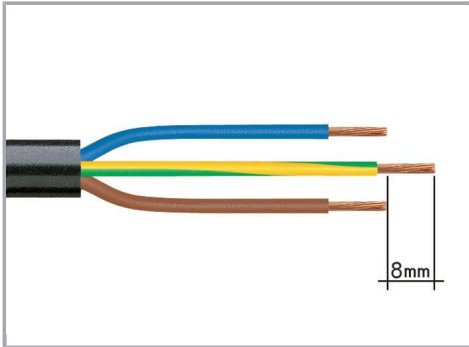

1. Strip length, outer insulation = 30 mm (2-pole), 37 mm (3-pole), 45 mm (4- and 5-pole)
2. Strip length = 9 mm
3. Extended ground conductor = 8 mm

To terminate fine-stranded conductors, open the clamping unit via screwdriver – 2.5 mm blade width – and insert a stripped conductor until it hits the backstop. Terminate solid conductors by simply pushing them in.

Subject to changes. Please also observe the further product documentation!

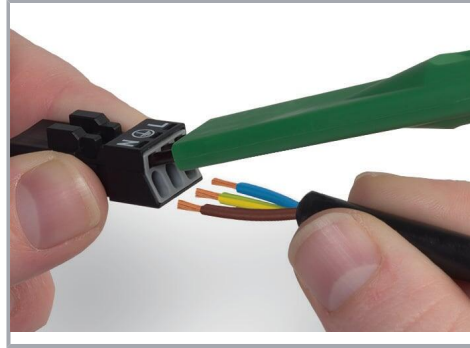
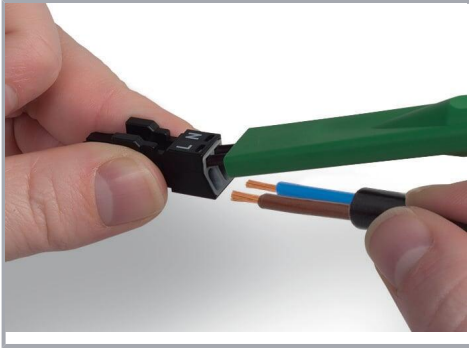

To terminate fine-stranded conductors, open clamping units via operating tool (890-382) and insert stripped conductors until they hit backstop.

To terminate fine-stranded conductors, open clamping units via operating tool (890-383) and insert stripped conductors until they hit backstop.

Terminate solid conductors by simply pushing them in.

Terminate solid conductors by simply pushing them in.

Installation

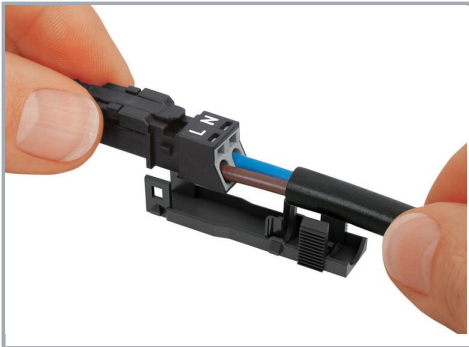

Latch the wired connector into the base of the strain relief housing.

Push down strain relief clamp by hand.

Subject to changes. Please also observe the further product documentation!



Push down strain relief clamp with 2.5 mm screwdriver alternately on both sides.

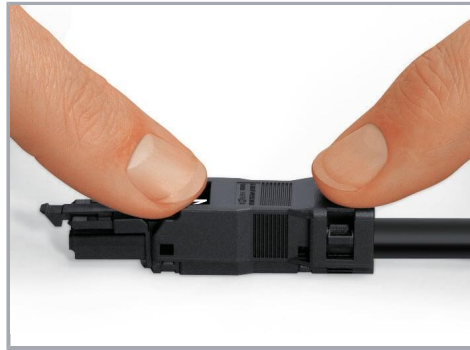

Latch the top of the strain relief housing.



The printed marking of the connector is clearly visible in the openings of the strain relief housing.

Shield termination



Connector with shield termination

Subject to changes. Please also observe the further product documentation!



Apply the shield to the sheathed cable.

Strip length, outer insulation = 30 mm

Shield length = 8 mm



Push the shield connecting plate into the connector until fully inserted.

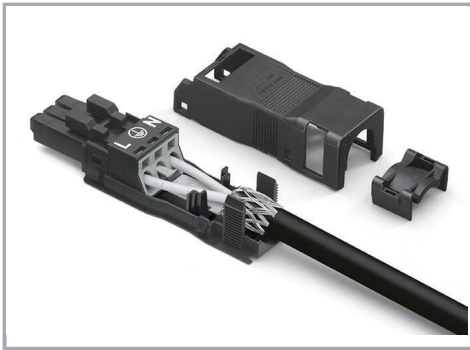

First insert the wired connector into strain relief housing, then snap clamp and cover.

Product family

WINSTA® MINI

[Show all products from the family](#)

Subject to changes. Please also observe the further product documentation!