



Serial Memory Products

- Serial EEPROM
- Serial SRAM

SERIAL MEMORY

P R O D U C T S



- Innovative Products
- Outstanding Quality
- Reliable Supply

Serial Memory Products

A broad portfolio of high performance, best-in-class Serial Memory Products to meet all your design requirements.

Microchip offers the broadest range of Serial EEPROM devices (from 128 bits to 1 Mbit) over the widest operating voltage (1.7 to 5.5V) and temperature ranges (up to 150°C). Innovative low-power designs and extensive testing have ensured industry leading endurance and best-in-class quality at low costs.

SPI-compatible Serial SRAM devices are available in 64 and 256 Kbit options and up to 20 MHz. These low power devices provide additional external serial RAM with high-speed performance and are available in standard 8-pin packages.

Microchip Supports Your Designs Throughout The Product Life Cycle

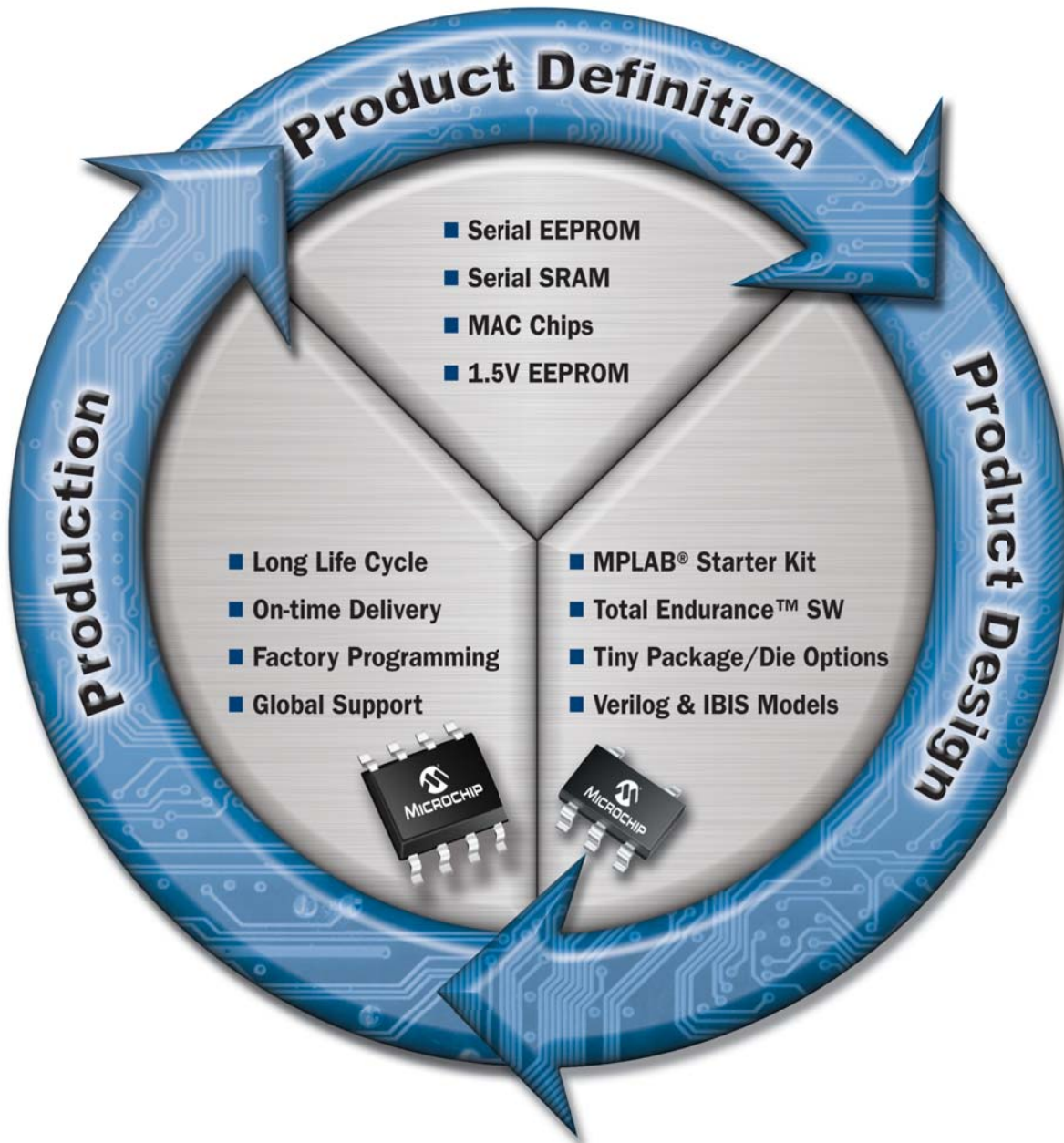

Serial Memory Advantages

Serial Memory Products

Outstanding Quality
Innovative Products
Reliable Supply

Serial EEPROM

- SPI, I²C™, Microwire, UNI/O® Bus
- Non-Volatile Memory
- 128 bits-1Mbit
- 1.7V-5.5V
- 1M Cycles E/W Endurance
- Fast Read/Write Times
- Low Power Consumption

Serial SRAM

- SPI Bus, 20 MHz
- Volatile Memory
- 8, 32 Kbytes
- 1.5V-1.95V; 2.7V-3.6V
- Infinite Endurance
- Zero Write Speeds
- Low Power

Key Features

- Serial architecture – I²C, SPI, UNI/O, Microwire
- Broad range of densities
- Tiny 3, 5, 6 and 8-pin packages, die & wafer
- Innovative, low power designs
- Industry leading endurance
- Wide temperature and voltage range
- Fast read and write times
- Flexible:
 - Byte write capability
 - Package options
 - Custom programming options
 - Application-specific serial memory
- Microchip owned fabs, In-house testing
- Automotive flow on all products

Key Benefits

- Lower system costs – innovative products, tiny packages, low power consumption, fewer I/O pins, small form factor
- Save I/O pins on the MCU – more compact designs, add additional features
- Secure data with write-protect options
- Highest quality EEPROMs
 - Zero PPM initiatives – Triple-test flow
 - >1M cycles E/W endurance
- Faster time to market
 - Short lead times
 - Complete tools support
- Robust designs – broad operating conditions
- Long product life cycles
- Global sales & engineering support

Serial EEPROM Bus Comparison

Parameter	I ² C	Microwire	UNI/O	SPI
Density Range	128b-1 Mbit	1 Kb-16 Kb	1 Kb-16 Kbit	1Kb-1 Mbit
Speed	Up to 1 MHz	Up to 3 MHz	Up to 100 KHz	Up to 20 MHz
I/O Pins	2: Clock, Data	4: Clock, CS, DI, DO	1: Clock/Data	4: SCK, CS, DI, DO
Package Options	PDIP, SOIC, SOIJ, TSSOP, MSOP, 2x3 T-DFN, 6x5 DFN, SOT-23, SC70, WLCSP	PDIP, SOIC, TSSOP, MSOP, 2x3 T-DFN, SOT-23	PDIP, SOIC, TSSOP, MSOP, 2x3 T-DFN, SOT-23, TO92, WLCSP	PDIP, SOIC, SOIJ, TSSOP, MSOP, 2x3 T-DFN, 6x5 DFN, SOT-23
Security Options	HW	HW	SW	HW, SW
Pricing	Least Expensive			Most Expensive

Serial EEPROM

Innovative designs combined with in-house fabrication and outstanding testing methodology has helped create the industry's highest quality Serial EEPROM.

Microchip offers a broad selection of standard and application specific Serial EEPROM devices that are available in all the standard serial busses – I²C, SPI, Microwire and the new single I/O UNI/O[®] bus.

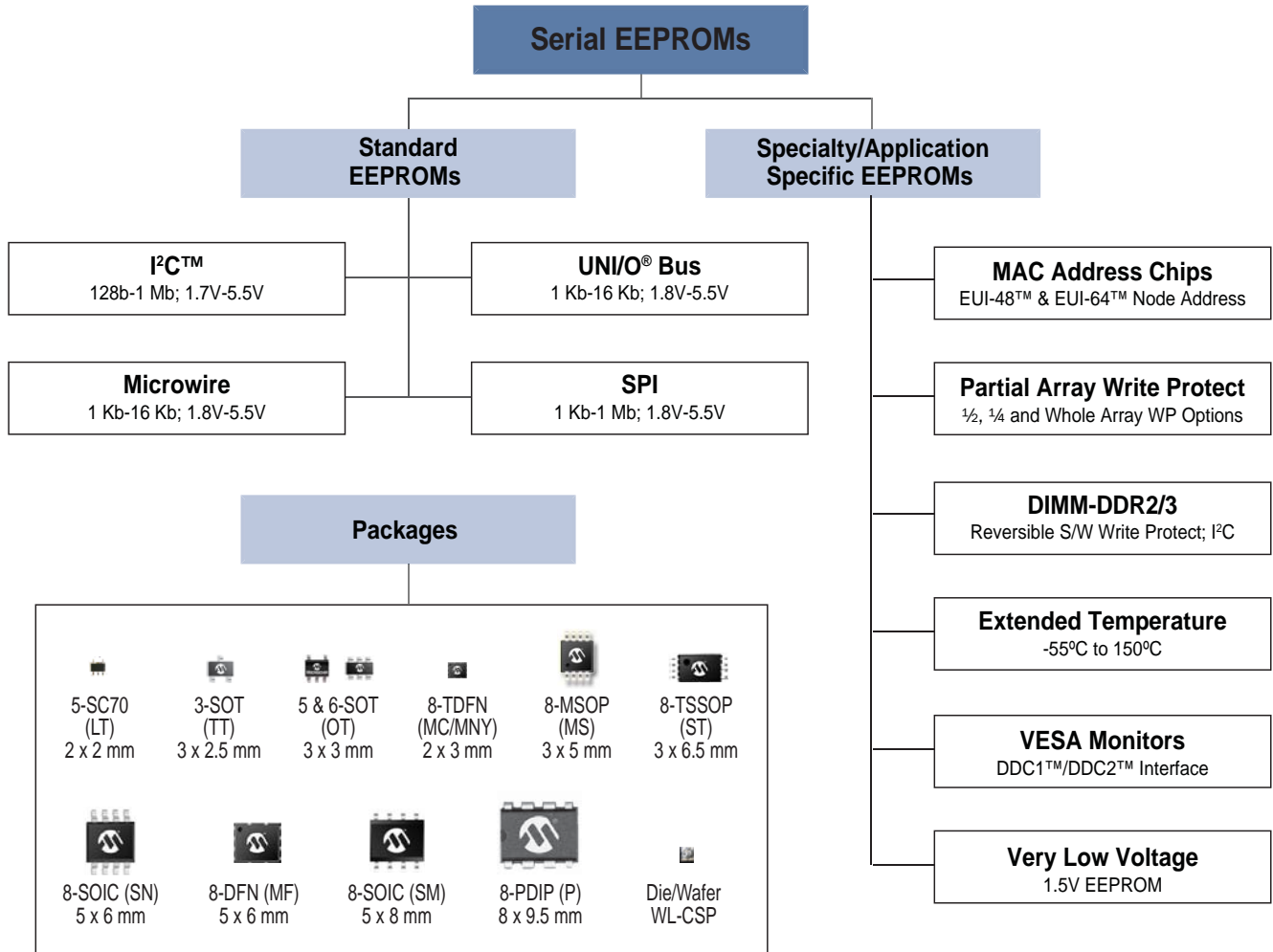

Robust Design

- ESD Protection
 - > 4000V Human Body Model (HBM)
 - > 400V Machine Model (MM)
 - > 1000V Charged Device Model
- Latch-up protection > 200 mA on all pins
- ESD Induced Latch-up > 100V (MM) on V_{DD}; >400V on all I/O
- > 1M cycles Endurance and > 200 years data retention
- Up to 150°C Operation (reads and writes)
- Power-On Reset (POR) and Brown-Out Reset (BOR)
 - Effective protection against noisy automotive environments
 - Eliminates false writes
- Schmitt Trigger input filters for noise reduction
- Complete traceability including die location on wafer

Quality

- Microchip delivers highest quality EEPROMs in the world
- World-class line yields (over 99%)
- ISO/TS16949-compliant
- Industry leader with triple test flow – every cell of every part is tested three times
- Near zero PPM field bit fails
- Statistical process control and continuous improvement procedures in all facilities
- Robustness and reliability designed in
- Automotive grade/flow

Memory Package Matrix

Memory Packages – more memory in less space!

Serial EEPROM devices from Microchip are available in a wide variety of tiny, innovative packages to help minimize your design – save board space and cost!

- WLCSP – die-sized package – smallest form factor EEPROM package in the world!
- SC70 – smallest 5-lead EEPROM package!
- 5-SOT-23 available up to 64 Kbit; 8-TDFN up to 128 Kbit, 8-SOIC up to 1 Mbit (I²C)

Density	Max Speed	SOIC SN	SOT-23 OT/TT	TSSOP TS	TDFN MNY/MC	PDIP P	MSOP MS	SOIJ SM	DFN MF	SC70 LT	T092 TO	Wafer W/S/WF	WLCSP CS
		5x6	3x3	3x6.5	2x3	8x9.5	3x5	5x8	5x6	2x2		Die	Die
I²C™ Bus 1.7V-5.5V													
128bit-2K	400 KHz	X	5	X	X	X	X			5		X	
4K-32K	400 KHz	X	5	X	X	X	X					X	X
64K	1 MHz	X	5	X	X	X	X	X				X	X
128K	1 MHz	X		X	X	X	X	X	X			X	X
256K	1 MHz	X		X		X	X	X	X			X	X
512K	1 MHz	X		X		X		X	X			X	X
1 Mbit	1 MHz	X				X		X					
Microwire Bus 1.8V-5.5V													
1K-16K	3 MHz	X	6	X	X	X	X					X	
SPI Bus 1.8V-5.5V													
1K-4K	10 MHz	X	6	X	X	X	X					X	
8K-64K	10 MHz	X		X	X	X	X					X	
128K, 256K	10 MHz	X		X		X		X	X			X	
512K	20 MHz	X		14		X		X	X			X	
1 Mbit	20 MHz					X		X	X			X	
UNI/O® Single-Wire Bus 1.8V-5.5V													
1K-16K	100 KHz	X	3		X	X	X				X	X	X

Package Sizes

										
5-SC70 (LT) 2 x 2 mm	3-SOT (TT) 3 x 2.5 mm	5 & 6-SOT (OT) 3 x 3 mm	8-TDFN (MC/MNY) 2 x 3 mm	8-MSOP (MS) 3 x 5 mm	8-TSSOP (ST) 3 x 6.5 mm	8-SOIC (SN) 5 x 6 mm	8-DFN (MF) 5 x 6 mm	8-SOIC (SM) 5 x 8 mm	8-PDIP (P) 8 x 9.5 mm	Die/Wafer WL-CSP

WLCSP – World’s Smallest EEPROM Package

WLCSP from Microchip is bumped die with a redistribution layer to route the bond pads to the bumps.



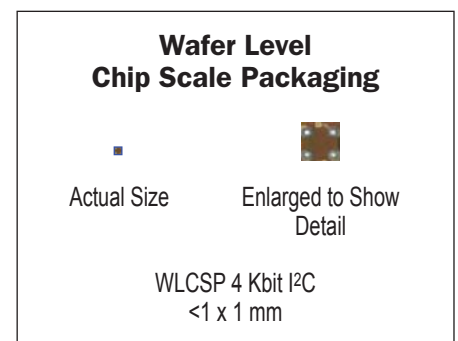

- True ‘die-sized’ packages
- Industry’s smallest package, form factor
- Lowest profile package
- Available in I²C, UNI/O buses
- Compatible with standard surface mount assembly lines
- Fit a large density into a small space
- Applications: mobile phones, security cameras, sensors, servers, networking, RF, medical, portable electronics



Application-Specific EEPROMs

Innovative EEPROM options to help you get to market faster and deliver the highest performance at lowest costs.

Serial Memory Products – Application Examples

	Microchip Strengths	Applications
 Automotive	Quality, PPAP, long product life cycles, AEC Q-100 & TSO-16949 compliant, in-house testing, triple-test flow	Transmission, ABS, Power Train, Airbag, Entertainment System, Mirror Controllers, GPS, Steering Control
 Medical	Outstanding quality, and reliability, tiny packages, low power, Microchip owned fabs	Blood Glucose Meters, Hearing Aid, Medical Imaging Devices, XRAY, Oxygen Concentrator, ECG
 Industrial	Robust designs, high endurance, wide operating range, custom part options	Metering, Industrial Control, Security Systems, Alarm Systems, Sensor Networks, Battery Chargers
 Consumer	Short lead times, excellent supply, innovative packages, application specific options, low power	LCD TV, Set Top Box, Printers, Blue Tooth, Wireless, Laptop, Mouse, Networking, DDR2/3, Camera, POS, Appliances

Specialty EEPROM Applications

Application/Market	Design Challenge	Solution	Products	Benefits
Monitors, Projectors, Flat Panel Display	DDC1™ & DDC2™, EDID & E-EDID specification	Vesa products	24LCS21A, 24LCS22A	Quick, easy plug & play options
Networking, Ethernet, Wi-Fi, ZigBee®	EUI-48™/EUI-64™ MAC Address	MAC address chips	24AA02E48, 11AA02E48, 25AA02E48	Easy access, Low-cost, Plug & play, Additional EEPROM
PCs and Laptops – DRAM DIMM Modules	DDR1/2/3 Specification	DIMM SPD products, Temp sensor with EEPROM	24LCS52, 34XX02, MCP98242	Customizable software enabled WP
Industrial, Consumer Electronics	Systems that require locked and/or re-writable memory	Write-protect options	I ² C, SPI, UNI/O and Microwire Options available	One lower cost device replace two stand-alone parts
HDCP Chipset (TV)	Adding HDCP keys to your chipset	Secure wafer programming service	4K/8K – I ² C, SPI, Microwire	Secure, No code duplication, Lower overall costs, Factory-programmed serialization
Industrial	Need devices to operate beyond -40C to +125C	High temp. EEPROMs: up to 150°C Low temp EEPROMs: down to -55°C	1 Kbit, I ² C and 1-256 Kbit SPI	Robust design, Reduce chances of field failures
Automotive	Automotive Qualification	Special manufacturing flow	All	Robust design, Hassle-free solution
Consumer Electronics, Medical	Need Very Low Voltage	Very Low Voltage EEPROMs	24VL014, 24VL024, 34VL02	Low power operation, Reduced system voltage

More Speciality EEPROMs

EUI-48™/EUI-64™ MAC Address Chips



Need fast, easy and inexpensive access to MAC addresses? Use pre-programmed MAC address chips from Microchip. No serialization needed; unique ID.

EUI-48 Programmed Serial EEPROMs provide low cost and easy access to IEEE MAC Addresses. These plug-and-play devices allow you to quickly add a MAC address to your networking application eliminating the need for programming and serialization on the MCU – helping you save cost and get to market quicker. For more information visit: www.microchip.com/MAC

24AA02E48 100 KHz	25AA02E48 10 MHz	11AA02E48 100 KHz
I ² C	SPI	UNI/O

Plug-and-Play Devices

EUI-48 address embedded in a 2K-bit Serial EEPROM

- Quick and easy access to IEEE MAC addresses – Read code directly off Serial EEPROM
- Available in SPI, I²C and UNI/O bus
- At least 1.5 Kb of Serial EEPROM memory
- Available in SOIC and SOT-23 packages
- Write-protected codes
- EUI-48 and EUI-64 compatible
 - EUI-48: Networking, Ethernet, Wi-Fi (IEEE 802.11), Bluetooth
 - EUI-64: ZigBee (IEEE802.15.4), MiWi™, FireWire, IPv6
- Can be custom programmed in any memory density. Contact Microchip sales for more information.

Flexibility and Low Cost Access

Quickly add EUI-48 to your networking application and get to market faster

- Buy code only when needed.
- No added programming and serialization cost – Reduce System Costs
- Come with no volume restrictions.
- Additional EEPROM to store configuration settings
- Unique ID

Partial Array Write-Protect I²C EEPROMs

Microchip's family of partial array write-protect (WP) EEPROMs offers hardware write-protect capability for only a part of the memory array. These I²C EEPROM devices are available from 1 Kb-64 Kbit.

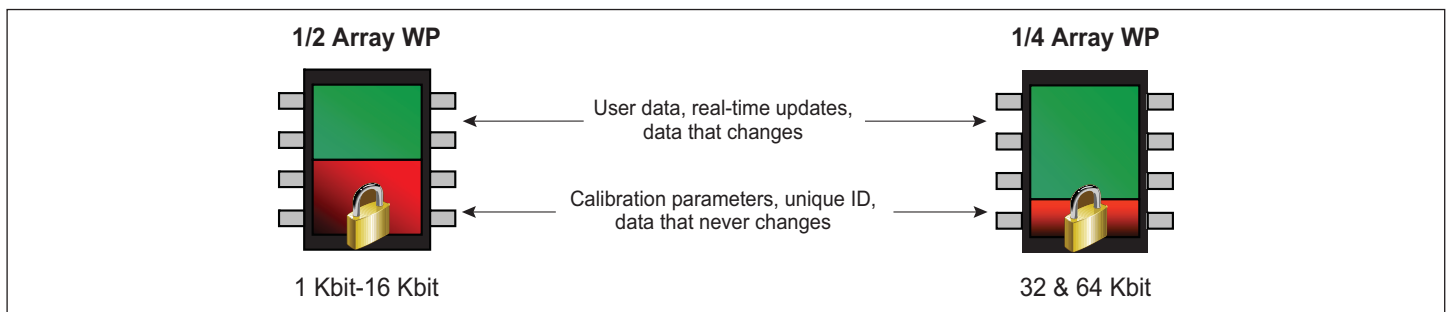

I²C and SPI Serial EEPROMs with Optional Range from -55°C to +150°C

- Automotive turbo chargers and exhaust gas recirculation
- Automotive fan motors, air valves, flaps and spark plugs
- Aerospace
- Mining (certifications for use in explosive atmospheres available)



UNI/O® EEPROM

Using UNI/O EEPROM can free up MCU pins for new features.



Microchip's new UNI/O Serial EEPROM uses only ONE connection to the host microcontroller. This compares to two or three pins for I²C, and three to six pins for Microwire or SPI buses. This new, proprietary bus offers advanced features like a status register and write-protection on demand, along with all I/O and memory array and command functions through a single pin.

2.5-5.5V	11LC010	11LC020	11LC040	11LC080	11LC160
1.8-5.5V	11AA010	11AA020	11AA040	11AA080	11AA160
	1 Kb	2 Kb	4 Kb	8 Kb	16 Kb

Single I/O EEPROM

One I/O for clock, data & control

- Single I/O interface
- 1-16 Kbit memory densities
- 1.8-5.5V operating voltage
- 10-100 KHz operating frequency
- Status register, SW write-protect
- 3-pin SOT-23, 8-pin SOIC, MSOP & TDFN
- 1M Erase/Write cycles



Save I/O Pins

A single I/O EEPROM can simplify your design and reduce system cost

- Free up pins on the MCU
 - Add new features to your application
 - Move to a smaller MCU – reduce cost
- Free up pins on your connector
 - Smaller connector – lower cost
- Single I/O interface – more compact design

The UNI/O Advantage

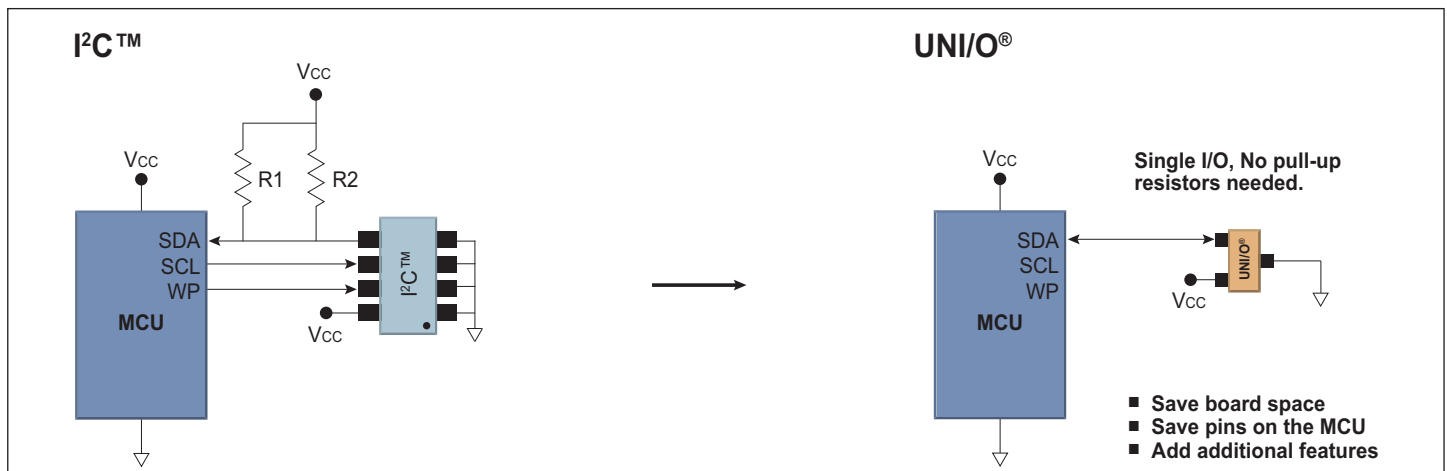

- UNI/O software drivers available for many popular microcontrollers See Ap Note section for more information.
- Convert UNI/O from 3-pins to 2-pins – check out Ap Note AN1213.

www.microchip.com/unio

Serial SRAM



Do you need a simple, inexpensive way to add RAM to your application? Microchip offers external RAM where you need it.

Microchip's new serial SRAM family provides a way to easily and inexpensively add external RAM to almost any application. These serial devices use less power and fewer I/O connections than traditional parallel SRAM. And, they allow designers to use a smaller microcontroller rather than moving to a larger microcontroller just to get more on-board RAM.

256 Kb	23A256 16 MHz	23K256 20 MHz
64 Kb	23A640 16 MHz	23K640 20 MHz
	1.5V-1.95V	2.7V-3.6V

- Applications: metering, POS terminals, printers, internet radio, ethernet, Wi-Fi
- Replace parallel RAM
- Any application needing low cost RAM

Increased Performance

Quickly and easily add external high-speed SRAM

- 8 and 32 Kbyte options
- 20 MHz clock speed
- Low standby and operating currents
- Fast writes with zero latency
- Unlimited endurance
- 8-SOIC, 8-TSSOP, 8-PDIP

Flexible RAM Expansion

Add features to your current microcontroller and get to market faster

- Add functionality to your current design
- No need to buy a large microcontroller just for the RAM
- Familiar 4-pin SPI interface
- Cost reduce your current design
- Scratchpad, buffering, high endurance applications

The Serial Advantage – Not Just Price

Feature	Traditional Parallel SRAM	Microchip Serial SRAM
I/O Connection to MCU	16-20	4
Standby Current	3 mA	1 μ A
Active Current	50 mA	1-10 mA
Lowest Operating Voltage	3.0V	1.7V
Footprint	100 mm ²	20 mm ²
Smallest Packages	28-TSSOP, 28-SOIC	8-TSSOP, 8-SOIC

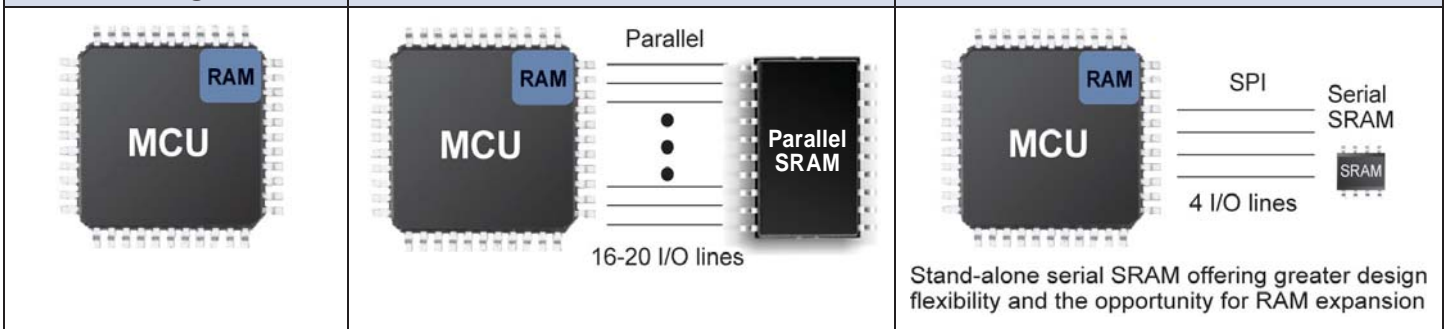

Wafer-Level Burn-In

Microchip's best-in-class field performance is the combined result of world class manufacturing, wafer level burn-in and wafer probe quality screens.

Microchip's Triple Test Flow is currently the most robust testing procedure for serial EEPROM devices in the industry. It tests each cell of each die three times and also performs extensive endurance and data retention tests to ensure quality and reliability.

Infant mortality of Microchip serial EEPROMs is among the lowest in the industry due to this extensive testing, excellent fabrication and highly reliable memory cell design.

Traditional Burn-in (Old Technology)

General purpose non-specific testing procedure for random logic cells

- Non-specific and untargeted testing mechanism – Increases failure rates.
- Expensive, time consuming and inefficient.
- Introduces defect modes like bent leads and EOS that sometimes go undetected.

Microchip's Triple Test and Wafer-level Burn-in Procedure

Moving beyond traditional burn-in to wafer level burn-in with the Triple Test Flow specifically targeted for memory cells has helped create the industry's most reliable memory products.

- Extensive Testing – Every cell in every die is tested three times, including specific endurance and data retention tests to ensure highest quality.
- HVST, LVHF and TVPP tests target specific defects.
- Maverick, SBY and GBN target overall failure patterns and trends.
- Insight into failure modes along with flexible test flow ensures continues improvement.

Triple Test Flow

Microchip tests every cell in wafer form twice, then performs a final test after assembly.

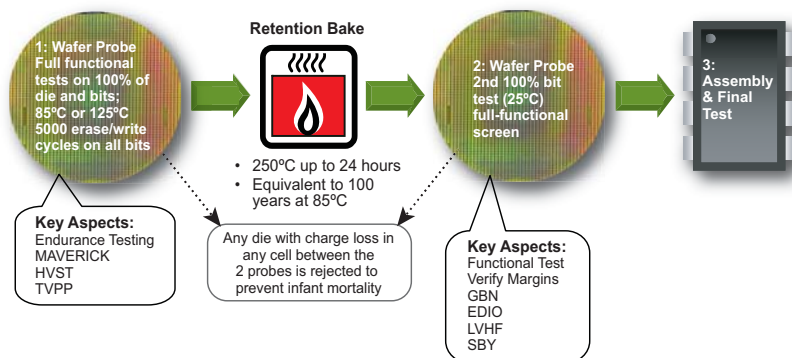

Main Goals – Zero Defects

- Full verification of data sheet parameters for functional compliance at die and package level.
- Removal of manufacturing defects to ensure highest quality and reliability.
- Screening out of functional devices that may fail in the future.

Wafer Probe Quality Screens

Microchip performs additional in-house testing during wafer probe to ensure quality and eliminate any devices that are outside the normal distribution or might possibly fail in the future.

High Voltage Stress Test (HVST)

HVST targets weak devices with oxide defects in RAM and logic circuits by stressing the oxides at higher than normal voltages.

Time at Vpp (TVPP)

TVPP targets oxide defects in EEPROM cells, charge pumps and other high-voltage circuits. Programming voltages (VPP) are applied to the memory array for an extended period of time in order to highlight any weak devices.

Low Voltage High Frequency (LVHF)

LVHF targets signal paths that are partially blocked and therefore more resistive than normal. LVHF eliminates these devices by requiring them to operate faster than specified and at voltages lower than specified.

Good Die in a Bad Neighborhood (GBN) and Edge Die Ink Out (EDIO)

Special algorithms target devices that function, but are suspect because of their proximity to clusters of failing devices or edge die.

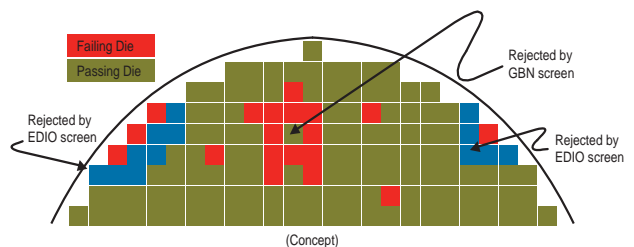

What Does All of This Mean?

- <<1 PPM Field Failures
- Best-in-class endurance
- Industry-leading data retention

Consistent, Reliable Supply of the Highest Quality Products

Microchip: A leader in non-volatile memory for over 20 years.

Perfecting testing mechanisms along with streamlined in-house fabrication ensures the highest efficiency, shortest lead times and lowest costs.

“Quality Comes First” is at the top of the list of Guiding Values for Microchip Technology. As an ISO/TS-16949 certified supplier since 2003, Microchip’s Aggregate System uniquely supports our commitment to exceptional quality. In an environment where enterprise-wide commitment to continuous improvement is demonstrated and every employee is responsible for quality.

- EEPROMs built at Microchip owned fabs (Gresham, OR, Tempe, AZ)
- No obsolescence policy – industry’s longest product life cycles
- 100% in-house testing on all of our products
- AECQ100, TS19649 and automotive grade compliant
- Industry’s shortest lead times
- Excellent global sales and technical support

With more than 20 years of experience in serving the demanding requirements of customers worldwide, Microchip Technology has a proven track record of success in delivering the total product solution to our valued customers that is cost effective and reliable.



**Corporate Headquarters
Chandler, Arizona**



**Fab 2
Tempe, Arizona**



**Fab 4
Gresham, Oregon**



**Product Assembly/Test
Bangkok, Thailand**

www.microchip.com/quality

Resources to Get You Started Quickly

Reduce development time and cost with our development tools.

Competitive market conditions force businesses to examine every aspect of their product life cycle to maximize productivity and minimize expense. Easy-to-learn, low-cost common development tools are one way to reduce risk and get to market quicker.

MPLAB® Starter Kit for Serial Memory Products (DV243003)



Reduce time to market and create a rock-solid design using the MPLAB Starter Kit for Serial Memory Products. It includes everything necessary to quickly develop a robust and reliable

Serial EEPROM design, and greatly reduces the time required for system integration and hardware/software fine-tuning.

- 3.3V and 5.0V on-board voltage selection
- Supports Microchip UNI/O bus, I²C, SPI and Microwire Serial EEPROMs
- 1.8V to 5.5V external voltage support
- Includes free copy of MPLAB IDE
- USB interconnect

Total Endurance™ Software

Total Endurance Software provides a comprehensive model that helps estimate the endurance and reliability of Microchip Serial EEPROM devices. By providing operating conditions based on your application, all design trade-offs affecting reliability can be accurately estimated both graphically and numerically in PPM, FIT and MTBF modes, saving time and ensuring a truly robust design.

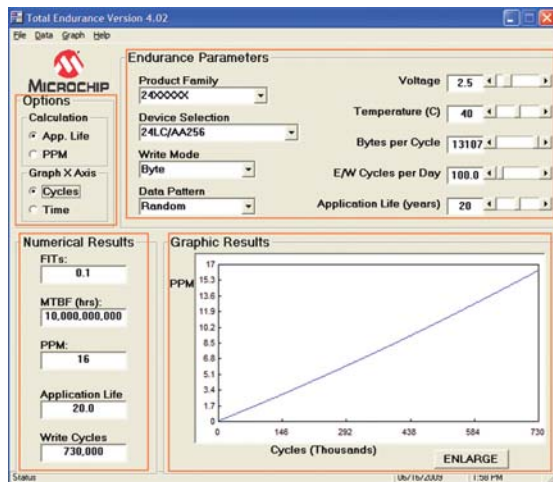

UNI/O® Bus Parasitic Power Demo Board (AC243004)



The UNI/O Bus Parasitic Power Demo Board is designed to illustrate how a standard half-wave rectifier and capacitor circuit can be used to parasitically extract power for a UNI/O device from the

SCIO signal as described in application note, AN1213 "Powering a UNI/O® Bus Device Through SCIO". This reduces the number of connections necessary for adding a UNI/O device to your application down to two: SCIO and V_{ss}.

Serial EEPROM PIM PICTail™ Pack (AC243003)



The Serial EEPROM PIM PICTail Modules are a series of boards designed around Microchip Serial EEPROM devices. The boards are designed to interface with the PICTail Plus connector as well as the MPLAB Starter Kit for Serial Memory Products and the PICKit 3, allowing you to get started right out of the box.

- Plug-and-play with PICTail Plus connector and PICKit 3 connector
- Test points for oscilloscope connections for firmware debugging (I²C and UNI/O only)
- Microwire Buses are included for maximum flexibility in developing your application

Reference Code Resources

Looking for reference code to interface with our serial memory?

Select your serial protocol, microcontroller and preferred implementation below.

Memory Application Notes – PIC® MCUs

Protocol	Memory Type	Recommended Usage	Implementation	PIC10	PIC12	PIC16	PIC18	PIC24/ dsPIC33	PIC32
UNI/O Bus	EEPROM	AN1194 (General Usage)	Assembly – Firmware Delay	AN1174 ¹	AN1174 ¹ AN1188 ²	AN1174 ¹ AN1188 ²	AN1183		
		AN1213 (Parasitic Power)	Assembly – Hardware Delay C – Hardware Delay		AN1196 ² AN1251 ²	AN1196 ² AN1251 ²	AN1187 AN1191	AN1236	
I ² C	EEPROM	AN1028	Assembly – Bit Bang	AN982	AN982	AN974	AN979		
			Assembly – Hardware Port			AN976	AN989		
			C – Bit Bang				AN997	AN1100	
			C – Hardware Port				AN991	AN1079	
Microwire	EEPROM	AN1029	Assembly – Bit Bang			AN993	AN999		
			Assembly – Hardware Port			AN975	AN1020		
			C – Bit Bang				AN1004		
			C – Hardware Port				AN1023		
SPI	EEPROM	AN1040	Assembly – Bit Bang			AN909	AN1006		
			Assembly – Hardware Port			AN966	AN1000		
			C – Bit Bang				AN1018	AN1096	
			C – Hardware Port				AN1040	AN1069	
	SRAM	AN1245	–			AN1287	AN1269	AN1262	AN1277
All EEPROMs		AN1019	EEPROM Endurance Tutorial						
		AN536	Basic Serial EEPROM Operation						
		AN603	Continuous Improvement						

Note 1: Written for baseline (12-bit program word) cores.

Note 2: Written for mid-range (14-bit program word) cores.

Memory Application Notes – Third-Party MCUs

Protocol	Implementation	8051	MSP430
UNI/O Bus	Assembly – Hardware Delay	AN1184	
	C – Hardware Delay	AN1185	AN1186
I ² C	Assembly – Bit Bang	AN1147	
	Assembly – Hardware Port	AN1190	
	C – Bit Bang	AN1195	
	C – Hardware Port	AN1113	
SPI	Assembly – Bit Bang	AN1198	
	Assembly – Hardware Port	AN1197	
	C – Bit Bang	AN1193	
	C – Hardware Port	AN1073	

Product Specifications

I²C™ Memory Products

Device	Density (Organization)	Max Clock Frequency	Operating Voltage (AA, LC, C)	Temperature (I, E, H)	Endurance (E/W Cycles)	Data Retention	Write Protect (Hardware)	Packages
24X00	128 bits (x8)	400 kHz	1.7V-5.5V	-40°C to +125°C	1M	200 years	No	PDIP, SOIC, TSSOP, SOT-23, 2x3 T-DFN
24X01/014	1 Kbit (x8)	400 kHz	1.7V-5.5V	-40°C to +150°C	1M	200 years	W, ½	PDIP, SOIC, TSSOP, SOT-23, 2x3 T-DFN, MSOP, SC70
24X02/024	2 Kbits (x8)	400 kHz	1.7V-5.5V	-40°C to +125°C	1M	200 years	W, ½	PDIP, SOIC, TSSOP, SOT-23, 2x3 T-DFN, MSOP, SC70
24X04	4 Kbits (x8)	400 kHz	1.7V-5.5V	-40°C to +125°C	1M	200 years	W, ½	PDIP, SOIC, TSSOP, SOT-23, 2x3 T-DFN, MSOP, WLCSP
24X08	8 Kbits (x8)	400 kHz	1.7V-5.5V	-40°C to +125°C	1M	200 years	W, ½	PDIP, SOIC, TSSOP, SOT-23, 2x3 T-DFN, MSOP
24X16	16 Kbits (x8)	400 kHz	1.7V-5.5V	-40°C to +125°C	1M	200 years	W, ½	PDIP, SOIC, TSSOP, SOT-23, 2x3 T-DFN, MSOP, WLCSP
24X32	32 Kbits (x8)	400 kHz	1.7V-5.5V	-40°C to +125°C	1M	200 years	W, ¼	PDIP, SOIC, TSSOP, SOT-23, 2x3 T-DFN, MSOP, WLCSP
24X64/65	64 Kbits (x8)	1 MHz	1.7V-5.5V	-40°C to +125°C	1M/10M	200 years	W, ¼	PDIP, SOIC, TSSOP, SOT-23, 2x3 T-DFN, MSOP, WLCSP
24X128	128 Kbits (x8)	1 MHz	1.7V-5.5V	-40°C to +125°C	1M	200 years	Yes	PDIP, SOIC, TSSOP, 2x3 T-DFN, 6x5 DFN, MSOP, WLCSP
24X256	256 Kbits (x8)	1 MHz	1.7V-5.5V	-40°C to +125°C	1M	200 years	Yes	PDIP, SOIC, TSSOP, 6x5 DFN, MSOP, WLCSP
24X512	512 Kbits (x8)	1 MHz	1.7V-5.5V	-40°C to +125°C	1M	200 years	Yes	PDIP, SOIC, TSSOP, 6x5 DFN, WLCSP
24X1025	1 Mbit (x8)	1 MHz	1.7V-5.5V	-40°C to +125°C	1M	200 years	Yes	PDIP, SOIC, SOIJ, 6x5 DFN

UNI/O® Bus EEPROM Products

Device	Density (Organization)	Max Clock Frequency	Operating Voltage (AA, LC)	Temperature (I, E)	Endurance (E/W Cycles)	Data Retention	Write Protect (Software)	Packages
11X010	1 Kbit (x8)	100 kHz	1.8V-5.5V	-40°C to +125°C	1M	200 years	W, ½, ¼	PDIP, SOIC, TSSOP, SOT-23, 2x3 T-DFN, MSOP, TO92, WLCSP
11X020	2 Kbits (x8)	100 kHz	1.8V-5.5V	-40°C to +125°C	1M	200 years	W, ½, ¼	PDIP, SOIC, TSSOP, SOT-23, 2x3 T-DFN, MSOP, TO92, WLCSP
11X040	4 Kbits (x8)	100 kHz	1.8V-5.5V	-40°C to +125°C	1M	200 years	W, ½, ¼	PDIP, SOIC, TSSOP, SOT-23, 2x3 T-DFN, MSOP, TO92, WLCSP
11X080	8 Kbits (x8)	100 kHz	1.8V-5.5V	-40°C to +125°C	1M	200 years	W, ½, ¼	PDIP, SOIC, TSSOP, SOT-23, 2x3 T-DFN, MSOP, TO92, WLCSP
11X160	16 Kbits (x8)	100 kHz	1.8V-5.5V	-40°C to +125°C	1M	200 years	W, ½, ¼	PDIP, SOIC, TSSOP, SOT-23, 2x3 T-DFN, MSOP, TO92, WLCSP

Microwire EEPROM Products

Device	Density (x8 or x16)	Max Clock Frequency	Operating Voltage (AA, LC, C)	Temperature (I, E)	Endurance (E/W Cycles)	Data Retention	Write Protect (Hardware)	Read Current	Packages
93X46A/B/C	1 Kbit	3 MHz	1.8V-5.5V	-40°C to +125°C	1M	200 years	No	1 mA	PDIP, SOIC, TSSOP, SOT-23, 2x3 T-DFN, MSOP
93X56A/B/C	2 Kbits	3 MHz	1.8V-5.5V	-40°C to +125°C	1M	200 years	No	1 mA	PDIP, SOIC, TSSOP, SOT-23, 2x3 T-DFN, MSOP
93X66A/B/C	4 Kbits	3 MHz	1.8V-5.5V	-40°C to +125°C	1M	200 years	No	1 mA	PDIP, SOIC, TSSOP, SOT-23, 2x3 T-DFN, MSOP
93X76A/B/C	8 Kbits	3 MHz	1.8V-5.5V	-40°C to +125°C	1M	200 years	Yes	1 mA	PDIP, SOIC, TSSOP, 2x3 T-DFN, MSOP
93X86A/B/C	16 Kbits	3 MHz	1.8V-5.5V	-40°C to +125°C	1M	200 years	Yes	1 mA	PDIP, SOIC, TSSOP, 2x3 T-DFN, MSOP

A: x8 Organization, B: x16 Organization, C: Selectable x8 or x16 Organization

SPI EEPROM Products

Device	Density (Organization)	Max Clock Frequency	Operating Voltage (AA, LC)	Temperature (I, E, H)	Endurance (E/W Cycles)	Data Retention	Write Protect (Software)	Packages
25X010A	1 Kbit (x8)	10 MHz	1.8V-5.5V	-40°C to +150°C	1M	200 years	W, ½, ¼	PDIP, SOIC, TSSOP, 2x3 T-DFN, MSOP, SOT-23
25X020A	2 Kbits (x8)	10 MHz	1.8V-5.5V	-40°C to +150°C	1M	200 years	W, ½, ¼	PDIP, SOIC, TSSOP, 2x3 T-DFN, MSOP, SOT-23
25X040A	4 Kbits (x8)	10 MHz	1.8V-5.5V	-40°C to +150°C	1M	200 years	W, ½, ¼	PDIP, SOIC, TSSOP, 2x3 T-DFN, MSOP, SOT-23
25X080C/D	8 Kbits (x8)	10 MHz	1.8V-5.5V	-40°C to +150°C	1M	200 years	W, ½, ¼	PDIP, SOIC, TSSOP, MSOP, 2x3 T-DFN
25X160C/D	16 Kbits (x8)	10 MHz	1.8V-5.5V	-40°C to +150°C	1M	200 years	W, ½, ¼	PDIP, SOIC, TSSOP, MSOP, 2x3 T-DFN
25X320A	32 Kbits (x8)	10 MHz	1.8V-5.5V	-40°C to +150°C	1M	200 years	W, ½, ¼	PDIP, SOIC, TSSOP, MSOP, 2x3 T-DFN
25X640A	64 Kbits (x8)	10 MHz	1.8V-5.5V	-40°C to +150°C	1M	200 years	W, ½, ¼	PDIP, SOIC, TSSOP, MSOP, 2x3 T-DFN
25X128	128 Kbits (x8)	10 MHz	1.8V-5.5V	-40°C to +150°C	1M	200 years	W, ½, ¼	PDIP, SOIC, TSSOP, 6x5 DFN
25X256	256 Kbits (x8)	10 MHz	1.8V-5.5V	-40°C to +150°C	1M	200 years	W, ½, ¼	PDIP, SOIC, TSSOP, 6x5 DFN
25X512	512 Kbits (x8)	20 MHz	1.8V-5.5V	-40°C to +125°C	1M	200 years	W, ½, ¼	PDIP, SOIC, 6x5 DFN
25X1024	1 Mbit (x8)	20 MHz	1.8V-5.5V	-40°C to +125°C	1M	200 years	W, ½, ¼	PDIP, SOIJ, 6x5 DFN

1. Voltage Range: AA = 1.7-5.5V; LC = 2.5-5.5V; C = 4.5-5.5V

2. I = -40°C to 85°C; E = -40°C to 125°C; H = -40°C to 150°C

3. Pb-Free, Halogen Free and RoHS Compliant

4. Write Protect: W = Whole Array, ½ = Half Array, ¼ = Quarter Array

5. ESD protection > 4 kV (HBM); > 400V (MM) on all pins

6. H Temp is SOIC only

Serial SRAM Products

Device	Density (Organization)	Max Clock Frequency	Operating Voltage (A, K)	Temperature (I, E)	Read Current (mA)	Max Standby Current	Packages
23x640	8KB (64 Kbits)	20 MHz	1.8V, 3V	-40°C to +125°C	3 mA	4 µA	PDIP, SOIC, TSSOP
23X256	32 KB (256 Kbits)	20 MHz	1.8V, 3V	-40°C to +125°C	3 mA	4 µA	PDIP, SOIC, TSSOP

1. Voltage Range: A = 1.5- 1.95V; K = 2.7V-3.6V

2. All Devices are Pb-Free, RoHS Compliant and Halogen Free

For up to date product information visit: www.microchip.com/memory

Serial Memory Ordering Information

Part Number Suffix Designations

Ordering information for Microchip SEEPRM products.

24 AA 02 T - I / SN

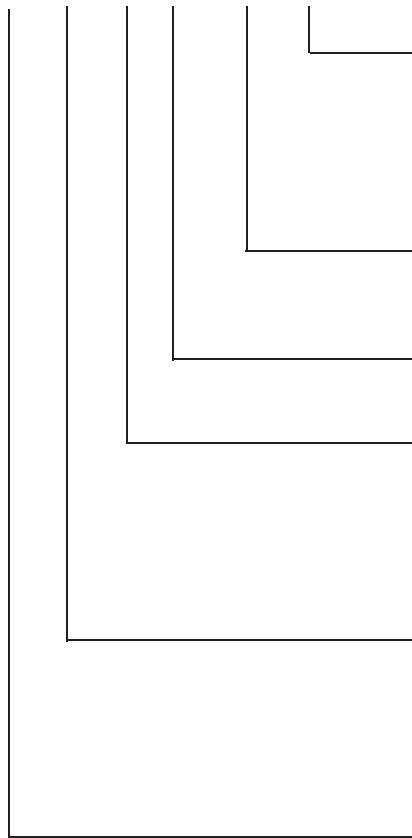

Package Type:

SN	8-SOIC (150 mil)	MNY/MC/MF	8-TDFN/DFN
TT/OT	3/5/6 SOT-23	LT	5-SC70
ST	8-TSSOP	W/WF/S	Wafer/Die
P	8-PDIP	CS	WLCSP – die size
SM	8-SOIJ (208 mil)	TO	T092
MS	8-MSOP		

Operating Temperature Range:

I:	Industrial (-40°C to +85°C)
E:	Extended Industrial Range (-40°C to +125°C)
H:	Extended (-40°C to +150°C)

Tape and Reel

T:	Tape and Reel
blank:	Standard (bulk)

Density:

00:	128 bits	32/320:	32 Kbit
01/010/014:	1 Kbit	64/640:	64 Kbit
02/020/024:	2 Kbit	128:	128 Kbit
04/040:	4 Kbit	256:	256 Kbit
08/080:	8 Kbit	512:	512 Kbit
16/160:	16 Kbit	1024/1025:	1 Mbit

Voltage Range:

AA	1.8V-5.5V
LC	2.5V-5.5V
C	4.5V-5.5V
K	1.8-3.6V
A	1.5-1.95V
VL	1.5V-3.6V

Bus Type:

24/34:	I ² C
25:	SPI
93:	Microwire
11:	UNI/O Bus
23:	SRAM (SPI)

Programming & Special Services

We can pre-program your EEPROMs before they ship.

Microchip offers custom programming options in package and die:

- QTP – All devices are programmed with same data
- SQTP – Each device is programmed with unique data

Do you have special product requirements?

Microchip offers customized versions of existing products:

- Lower V_{DD} (<1.5V in some cases)
- Extreme temperature (< -55°C to >+150°C)
- More endurance, up to 10M cycles
- Lower current specs (read, write, standby)
- Higher speed
- Customer design modifications:
 - Different I²C and UNI/O addresses
 - Custom voltage ranges

Get started today... additional resources at:
www.microchip.com/memory

- Datasheets and application notes (with code)
- Verilog, IBIS models
- Usage recommendation ap notes
- Webinars at www.microchip.com/webinars
- Samples at www.microchip.com/samples
- Tools and demo boards

Support

Microchip is committed to supporting its customers in developing products faster and more efficiently. We maintain a worldwide network of field applications engineers and technical support ready to provide product and system assistance. In addition, the following service areas are available at www.microchip.com:

- **Support** link provides a way to get questions answered fast: <http://support.microchip.com>
- **Sample** link offers evaluation samples of any Microchip device: <http://sample.microchip.com>
- **Forum** link provides access to knowledge base and peer help: <http://forum.microchip.com>
- **Buy** link provides locations of Microchip Sales Channel Partners: www.microchip.com/sales

Sales Office Listing

AMERICAS

Atlanta

Tel: 678-957-9614

Boston

Tel: 774-760-0087

Chicago

Tel: 630-285-0071

Cleveland

Tel: 216-447-0464

Dallas

Tel: 972-818-7423

Detroit

Tel: 248-538-2250

Kokomo

Tel: 765-864-8360

Los Angeles

Tel: 949-462-9523

Santa Clara

Tel: 408-961-6444

Toronto

Mississauga, Ontario

Tel: 905-673-0699

EUROPE

Austria - Wels

Tel: 43-7242-2244-39

Denmark - Copenhagen

Tel: 45-4450-2828

France - Paris

Tel: 33-1-69-53-63-20

Germany - Munich

Tel: 49-89-627-144-0

Italy - Milan

Tel: 39-0331-742611

Netherlands - Drunen

Tel: 31-416-690399

Spain - Madrid

Tel: 34-91-708-08-90

UK - Wokingham

Tel: 44-118-921-5869

Training

If additional training interests you, then Microchip can help. We continue to expand our technical training options, offering a growing list of courses and in-depth curriculum locally, as well as significant online resources – whenever you want to use them.

- Regional Training Centers: www.microchip.com/rtc
- MASTERS Conferences: www.microchip.com/masters
- Worldwide Seminars: www.microchip.com/seminars
- eLearning: www.microchip.com/webseminars
- Resources from our Distribution and Third Party Partners www.microchip.com/training

ASIA/PACIFIC

Australia - Sydney

Tel: 61-2-9868-6733

China - Beijing

Tel: 86-10-8528-2100

China - Chengdu

Tel: 86-28-8665-5511

China - Hong Kong SAR

Tel: 852-2401-1200

China - Nanjing

Tel: 86-25-8473-2460

China - Qingdao

Tel: 86-532-8502-7355

China - Shanghai

Tel: 86-21-5407-5533

China - Shenyang

Tel: 86-24-2334-2829

China - Shenzhen

Tel: 86-755-8203-2660

China - Wuhan

Tel: 86-27-5980-5300

China - Xiamen

Tel: 86-592-2388138

China - Xian

Tel: 86-29-8833-7252

China - Zhuhai

Tel: 86-756-3210040

ASIA/PACIFIC

India - Bangalore

Tel: 91-80-3090-4444

India - New Delhi

Tel: 91-11-4160-8631

India - Pune

Tel: 91-20-2566-1512

Japan - Yokohama

Tel: 81-45-471- 6166

Korea - Daegu

Tel: 82-53-744-4301

Korea - Seoul

Tel: 82-2-554-7200

Malaysia - Kuala Lumpur

Tel: 60-3-6201-9857

Malaysia - Penang

Tel: 60-4-227-8870

Philippines - Manila

Tel: 63-2-634-9065

Singapore

Tel: 65-6334-8870

Taiwan - Hsin Chu

Tel: 886-3-6578-300

Taiwan - Kaohsiung

Tel: 886-7-536-4818

Taiwan - Taipei

Tel: 886-2-2500-6610

Thailand - Bangkok

Tel: 66-2-694-1351

3/26/09

Microcontrollers • Digital Signal Controllers • Analog • Serial EEPROMs

The Microchip name and logo, the Microchip logo, MPLAB, PIC and UNI/O are registered trademarks of Microchip Technology Incorporated in the U.S.A. and other countries. PICkit, PICtail and Total Endurance is a trademark of Microchip Technology Incorporated in the U.S.A. and other countries. All other trademarks mentioned herein are property of their respective companies. © 2010, Microchip Technology Incorporated, All Rights Reserved. Printed in the U.S.A. 3/10 DS22239A



MICROCHIP
www.microchip.com

Microchip Technology Inc.
2355 W. Chandler Blvd.
Chandler, AZ 85224-6199