

RECOMMENDED PCB HOLE LAYOUT

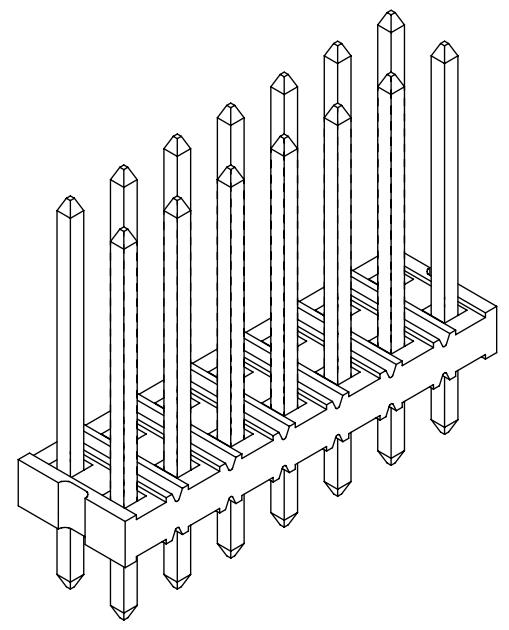
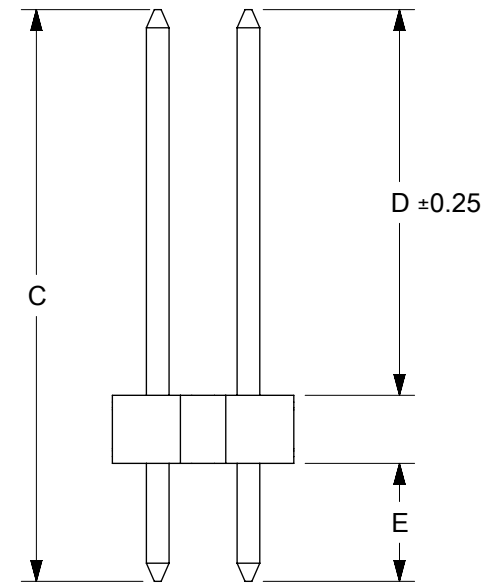
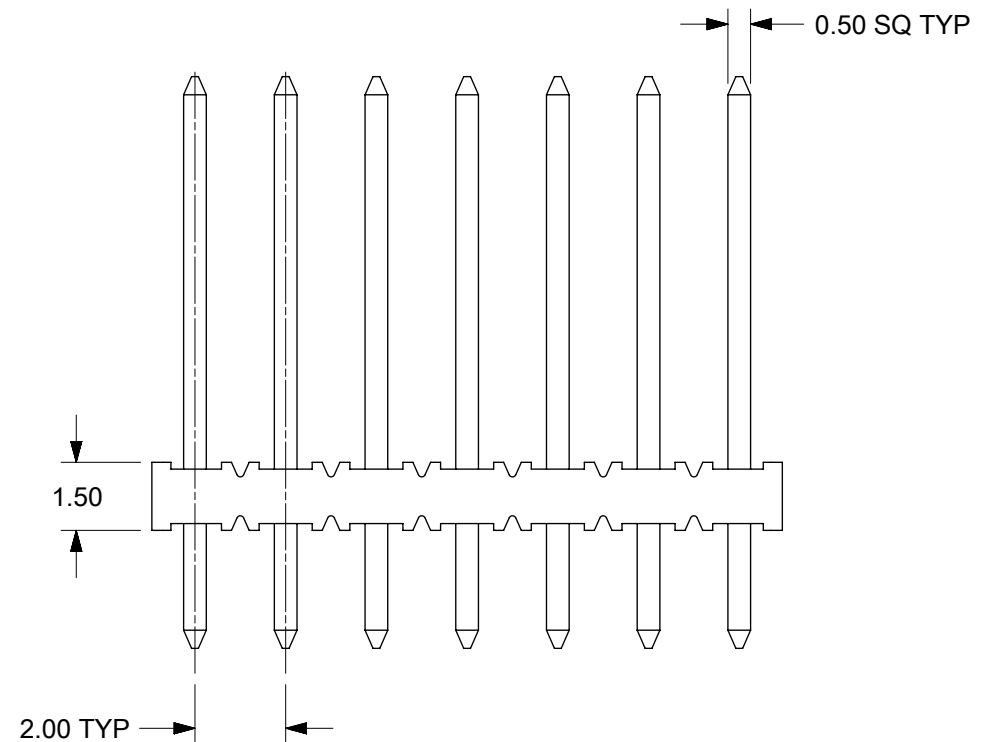

NOTES:

1. MATERIAL:
 - HOUSING: 30% G.F. NYLON 46, UL94V-0,
 - COLOR: BLACK
 - TERMINAL: COPPER ALLOY 0.50mm SQ
2. PLATING TYPE:
 - (1) GOLD FLASH OVER
50 MICRO INCHES MIN. NICKEL OVERALL.
 - (2) 1 MICRO INCHES MIN. GOLD PLATE ON CONTACT AND
75 MICRO INCHES MIN. TIN ON SOLDER TAIL OVER
50 MICRO INCHES MIN. NICKEL OVERALL.
 - (3) 10 MICRO INCHES MIN. GOLD PLATE ON CONTACT AND
75 MICRO INCHES MIN. TIN ON SOLDER TAIL OVER
50 MICRO INCHES MIN. NICKEL OVERALL.
 - (4) 15 MICRO INCHES MIN. GOLD PLATE ON CONTACT AND
75 MICRO INCHES MIN. TIN ON SOLDER TAIL OVER
50 MICRO INCHES MIN. NICKEL OVERALL.
 - (5) 30 MICRO INCHES MIN. GOLD PLATE ON CONTACT AND
75 MICRO INCHES MIN. TIN ON SOLDER TAIL OVER
50 MICRO INCHES MIN. NICKEL OVERALL.
 - (6) 100 MICRO INCHES MIN. TIN IN SELECTED AREA OVER
50 MICRO INCHES MIN. NICKEL OVERALL.
3. PIN PUSHOUT FORCE: 1KG MIN IN EITHER DIRECTION
4. THE ABOVE 14 CKT IS FOR ILLUSTRATION PURPOSE ONLY.
5. FOR PACKAGING OPTION PLEASE REFER TO THE TABLE.
6. CAP TO BE PLACED AT APPROXIMATELY CENTRAL OF THE DIM. B

THIS DRAWING CONTAINS INFORMATION THAT IS PROPRIETARY TO MOLEX ELECTRONIC TECHNOLOGIES, LLC AND SHOULD NOT BE USED WITHOUT WRITTEN PERMISSION									
DIMENSION UNITS		SCALE		CURRENT REV DESC: BRIGHT TIN PHASE OUT					
mm		NTS							
GENERAL TOLERANCES (UNLESS SPECIFIED)				EC NO: 679909		SALES DRAWING		2.00MM DUAL ROW HEADER SINGLE WAFER T/H	
				DRWN: AKUMAR19		PRODUCT CUSTOMER DRAWING			
				CHK'D: MRAMAKRISHNA		DOCUMENT NUMBER		DOC TYPE DOC PART REVISION	
4 PLACES ±				APPR: MRAMAKRISHNA		SD-87758-030		PSD 001 B2	
3 PLACES ±				INITIAL REVISION:		SERIES		MATERIAL NUMBER	
2 PLACES ± 0.2				DRWN: KCHO		87758		CUSTOMER	
1 PLACE ±				APPR: SLOW		SEE TABLE		GENERAL MARKET	
0 PLACES ±				ANGULAR TOL ± 3.0°		SHEET NUMBER		1 OF 4	
DRAFT WHERE APPLICABLE MUST REMAIN WITHIN DIMENSIONS				THIRD ANGLE PROJECTION		DRAWING		A3-SIZE	

DOCUMENT STATUS	P1	RELEASE DATE	2021/10/11	11:53:16
-----------------	----	--------------	------------	----------

PACKAGING OPRTION PART NO.			CKT SIZE	VOID POSITION	PLATING TYPE	CAP	PEG	DIMENSION				
TRAY	TUBE WITHOUT CAP	TUBE WITH CAP						A	B	C	D	E
87758-0201	----	----	2	----	1	N	N	1.90	----	12.60	8.50	2.60
87758-0202	----	----	2	----	2	N	N	1.90	----	12.60	8.50	2.60
87758-0203	----	----	2	----	3	N	N	1.90	----	12.60	8.50	2.60
87758-0204	----	----	2	----	4	N	N	1.90	----	12.60	8.50	2.60
87758-0205	----	----	2	----	5	N	N	1.90	----	12.60	8.50	2.60
87758-0206	----	----	2	----	6	N	N	1.90	----	12.60	8.50	2.60
87758-0401	----	----	4	----	1	N	N	3.90	2.00	12.60	8.50	2.60
87758-0402	----	----	4	----	2	N	N	3.90	2.00	12.60	8.50	2.60
87758-0403	----	----	4	----	3	N	N	3.90	2.00	12.60	8.50	2.60
87758-0404	----	----	4	----	4	N	N	3.90	2.00	12.60	8.50	2.60
87758-0405	----	----	4	----	5	N	N	3.90	2.00	12.60	8.50	2.60
87758-0406	----	----	4	----	6	N	N	3.90	2.00	12.60	8.50	2.60
87758-0420	----	----	4	----	5	N	N	3.90	2.00	15.50	11.50	2.50
87758-0601	----	----	6	----	1	N	N	5.90	4.00	12.60	8.50	2.60
87758-0602	----	----	6	----	2	N	N	5.90	4.00	12.60	8.50	2.60
87758-0603	----	----	6	----	3	N	N	5.90	4.00	12.60	8.50	2.60
87758-0604	----	----	6	----	4	N	N	5.90	4.00	12.60	8.50	2.60
87758-0605	----	----	6	----	5	N	N	5.90	4.00	12.60	8.50	2.60
87758-0606	----	----	6	----	6	N	N	5.90	4.00	12.60	8.50	2.60
87758-0620	----	----	6	----	5	N	N	5.90	4.00	15.50	11.50	2.50
87758-0647	----	----	6	----	4	N	N	5.90	4.00	11.45	6.85	3.10

PACKAGING OPRTION PART NO.			CKT SIZE	VOID POSITION	PLATING TYPE	CAP	PEG	DIMENSION				
TRAY	TUBE WITHOUT CAP	TUBE WITH CAP						A	B	D	C	E
87758-0801	----	----	8	----	1	N	N	7.90	6.00	12.60	8.50	2.60
87758-0802	----	----	8	----	2	N	N	7.90	6.00	12.60	8.50	2.60
87758-0803	----	----	8	----	3	N	N	7.90	6.00	12.60	8.50	2.60
87758-0804	----	----	8	----	4	N	N	7.90	6.00	12.60	8.50	2.60
87758-0805	----	----	8	----	5	N	N	7.90	6.00	12.60	8.50	2.60
87758-0806	----	----	8	----	6	N	N	7.90	6.00	12.60	8.50	2.60
87758-0846	----	----	8	----	4	N	N	7.90	6.00	6.38	10.50	2.60
87758-0008	----	----	8	----	4	N	N	7.90	6.00	10.00	14.10	2.60
87758-0808	----	----	8	----	5	N	N	7.90	6.00	9.70	4.00	4.20
87758-0820	----	----	8	----	1	N	N	7.90	6.00	11.50	5.00	5.00
87758-1001	----	----	10	----	1	N	N	9.90	8.00	12.60	8.50	2.60
87758-1002	----	----	10	----	2	N	N	9.90	8.00	12.60	8.50	2.60
87758-1003	----	----	10	----	3	N	N	9.90	8.00	12.60	8.50	2.60
87758-1004	----	----	10	----	4	N	N	9.90	8.00	12.60	8.50	2.60
87758-1005	----	----	10	----	5	N	N	9.90	8.00	12.60	8.50	2.60
87758-1006	----	----	10	----	6	N	N	9.90	8.00	12.60	8.50	2.60
87758-1007	----	----	10	10	4	N	N	9.90	8.00	8.10	4.00	2.60
87758-1008	----	----	10	10	5	N	N	9.90	8.00	8.70	4.00	3.20
87758-1012	----	----	10	----	4	N	N	9.90	8.00	11.75	7.65	2.60
87758-1020	B1	----	10	2	1	N	N	9.90	8.00	4.00	9.50	4.00
87758-1201	----	----	12	----	1	N	N	11.90	10.00	12.60	8.50	2.60
87758-1202	----	----	12	----	2	N	N	11.90	10.00	12.60	8.50	2.60
87758-1203	----	----	12	----	3	N	N	11.90	10.00	12.60	8.50	2.60
87758-1204	----	----	12	----	4	N	N	11.90	10.00	12.60	8.50	2.60
87758-1205	----	----	12	----	5	N	N	11.90	10.00	12.60	8.50	2.60
87758-1206	----	----	12	----	6	N	N	11.90	10.00	12.60	8.50	2.60
87758-1220	----	----	12	----	5	N	N	11.90	10.00	15.50	11.50	2.50

THIS DRAWING CONTAINS INFORMATION THAT IS PROPRIETARY TO MOLEX ELECTRONIC TECHNOLOGIES, LLC AND SHOULD NOT BE USED WITHOUT WRITTEN PERMISSION

DIMENSION UNITS	SCALE	CURRENT REV DESC: BRIGHT TIN PHASE OUT		molex		
mm	NTS					
GENERAL TOLERANCES (UNLESS SPECIFIED)				SALES DRAWING 2.00MM DUAL ROW HEADER SINGLE WAFER T/H		
				PRODUCT CUSTOMER DRAWING		
4 PLACES	±			DOCUMENT NUMBER		
3 PLACES	±			SD-87758-030		
2 PLACES	±	0.2		DOC TYPE	DOC PART	REVISION
1 PLACE	±			PSD	001	B2
0 PLACES	±			SHEET NUMBER		
ANGULAR TOL	±	3.0°		2 OF 4		
DRAFT WHERE APPLICABLE MUST REMAIN WITHIN DIMENSIONS		THIRD ANGLE PROJECTION	DRAWING	SERIES	MATERIAL NUMBER	CUSTOMER
			A3-SIZE	87758	SEE TABLE	GENERAL MARKET

10 9 8 7 6 5 4 3 2 1

PACKAGING OPRTION PART NO.			CKT SIZE	VOID POSITION	PLATING TYPE	CAP	PEG	DIMENSION				
TRAY	TUBE WITHOUT CAP	TUBE WITH CAP						A	B	C	D	E
87758-1401	----	----	14	----	1	N	N	13.90	12.00	12.60	8.50	2.60
87758-1402	----	----	14	----	2	N	N	13.90	12.00	12.60	8.50	2.60
87758-1403	----	----	14	----	3	N	N	13.90	12.00	12.60	8.50	2.60
87758-1404	----	----	14	----	4	N	N	13.90	12.00	12.60	8.50	2.60
87758-1405	----	----	14	----	5	N	N	13.90	12.00	12.60	8.50	2.60
87758-1406	----	----	14	----	6	N	N	13.90	12.00	12.60	8.50	2.60
87758-0014	----	----	14	----	4	N	N	13.90	12.00	8.40	5.50	1.40
87758-1492	----	----	14	----	6	N	N	13.90	12.00	14.40	10.00	2.90
87758-1601	----	----	16	----	1	N	N	15.90	14.00	12.60	8.50	2.60
87758-1602	----	----	16	----	2	N	N	15.90	14.00	12.60	8.50	2.60
87758-1603	----	----	16	----	3	N	N	15.90	14.00	12.60	8.50	2.60
87758-1604	----	----	16	----	4	N	N	15.90	14.00	12.60	8.50	2.60
87758-1605	----	----	16	----	5	N	N	15.90	14.00	12.60	8.50	2.60
87758-1606	----	----	16	----	6	N	N	15.90	14.00	12.60	8.50	2.60
87758-0016	----	----	16	----	6	N	N	15.90	14.00	10.30	6.30	2.50
87758-0017	----	----	16	----	6	N	N	15.90	14.00	10.70	6.60	2.60
87758-0018	----	----	16	----	6	N	N	15.90	14.00	10.30	6.30	2.50
87758-1620	----	----	16	----	5	N	N	15.90	14.00	16.40	11.70	3.20
87758-1801	----	----	18	----	1	N	N	17.90	16.00	12.60	8.50	2.60
87758-1802	----	----	18	----	2	N	N	17.90	16.00	12.60	8.50	2.60
87758-1803	----	----	18	----	3	N	N	17.90	16.00	12.60	8.50	2.60
87758-1804	----	----	18	----	4	N	N	17.90	16.00	12.60	8.50	2.60
87758-1805	----	----	18	----	5	N	N	17.90	16.00	12.60	8.50	2.60
87758-1806	----	----	18	----	6	N	N	17.90	16.00	12.60	8.50	2.60

PACKAGING OPRTION PART NO.			CKT SIZE	VOID POSITION	PLATING TYPE	CAP	PEG	DIMENSION				
TRAY	TUBE WITHOUT CAP	TUBE WITH CAP						A	B	C	D	E
87758-2001	----	----	20	----	1	N	N	19.90	18.00	12.60	8.50	2.60
87758-2002	----	----	20	----	2	N	N	19.90	18.00	12.60	8.50	2.60
87758-2003	----	----	20	----	3	N	N	19.90	18.00	12.60	8.50	2.60
87758-2004	----	----	20	----	4	N	N	19.90	18.00	12.60	8.50	2.60
87758-2005	----	----	20	----	5	N	N	19.90	18.00	12.60	8.50	2.60
87758-2005	----	----	20	----	6	N	N	19.90	18.00	12.60	8.50	2.60
87758-0006	----	----	20	----	5	N	N	19.90	18.00	11.92	5.21	5.21
87758-2046	----	----	20	----	5	N	N	19.90	18.00	7.70	4.45	1.75
87758-2201	----	----	22	----	1	N	N	21.90	20.00	12.60	8.50	2.60
87758-2202	----	----	22	----	2	N	N	21.90	20.00	12.60	8.50	2.60
87758-2203	----	----	22	----	3	N	N	21.90	20.00	12.60	8.50	2.60
87758-2204	----	----	22	----	4	N	N	21.90	20.00	12.60	8.50	2.60
87758-2205	----	----	22	----	5	N	N	21.90	20.00	12.60	8.50	2.60
87758-2206	----	----	22	----	6	N	N	21.90	20.00	12.60	8.50	2.60
87758-2401	----	----	24	----	1	N	N	23.90	22.00	12.60	8.50	2.60
87758-2402	----	----	24	----	2	N	N	23.90	22.00	12.60	8.50	2.60
87758-2403	----	----	24	----	3	N	N	23.90	22.00	12.60	8.50	2.60
87758-2404	----	----	24	----	4	N	N	23.90	22.00	12.60	8.50	2.60
87758-2405	----	----	24	----	5	N	N	23.90	22.00	12.60	8.50	2.60
87758-2406	----	----	24	----	6	N	N	23.90	22.00	12.60	8.50	2.60

DOCUMENT STATUS P1 RELEASE DATE 2021/10/11 11:53:16

THIS DRAWING CONTAINS INFORMATION THAT IS PROPRIETARY TO MOLEX ELECTRONIC TECHNOLOGIES, LLC AND SHOULD NOT BE USED WITHOUT WRITTEN PERMISSION

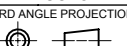
DIMENSION UNITS	SCALE	CURRENT REV DESC: BRIGHT TIN PHASE OUT	
mm	NTS		
GENERAL TOLERANCES (UNLESS SPECIFIED)			
	MM	INCH	
4 PLACES	±	±	
3 PLACES	±	±	
2 PLACES	± 0.2	±	
1 PLACE	±	±	
0 PLACES	±	±	
ANGULAR TOL	± 3.0°		
DRAFT WHERE APPLICABLE MUST REMAIN WITHIN DIMENSIONS		THIRD ANGLE PROJECTION	DRAWING
			A3-SIZE
		SERIES	87758
		MATERIAL NUMBER	SEE TABLE
		CUSTOMER	GENERAL MARKET
		SHEET NUMBER	3 OF 4

EC NO: 679909
 DRWN: AKUMAR19 2021/06/15
 CHK'D: MRAMAKRISHNA 2021/10/11
 APPR: MRAMAKRISHNA 2021/10/11

INITIAL REVISION:
 DRWN: KCHO 2004/11/05
 APPR: SLOW 2004/11/26

DOCUMENT NUMBER: SD-87758-030
 DOC TYPE: PSD
 DOC PART: 001
 REVISION: B2

9 8 7 6 5 4 3 2 1

PACKAGING OPRTION PART NO.			CKT SIZE	VOID POSITION	PLATING TYPE	CAP	PEG	DIMENSION				
TRAY	TUBE WITHOUT CAP	TUBE WITH CAP						A	B	C	D	E
87758-0002	----	----	26	26	4	N	N	25.90	24.00	9.56	4.06	4.00
87758-2608	----	----	26	----	5	N	N	25.90	24.00	9.70	4.00	4.20
87758-2672	----	----	26	----	4	Y	N	25.90	24.00	12.76	8.66	2.60
87758-0009	----	----	40	----	4	N	N	39.90	38.00	11.98	5.24	5.24
87758-4000	----	----	40	----	4	N	N	39.90	38.00	12.80	7.90	3.40
87758-7006	----	----	42	19 & 22	1	N	N	41.90	40.00	12.7	8.50	2.70
87758-4471	----	----	44	19	5	N	N	43.90	42.00	8.10	4.00	2.60
87758-4477	----	----	44	20	4	N	N	43.90	42.00	8.10	4.00	2.60
87758-5099	----	----	50	----	4	N	N	49.90	48.00	11.00	6.50	3.00
87758-0050	----	----	50	----	4	N	N	49.90	48.00	18.70	13.00	4.20

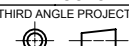
THIS DRAWING CONTAINS INFORMATION THAT IS PROPRIETARY TO MOLEX ELECTRONIC TECHNOLOGIES, LLC AND SHOULD NOT BE USED WITHOUT WRITTEN PERMISSION											
DIMENSION UNITS		SCALE		CURRENT REV DESC: BRIGHT TIN PHASE OUT							
mm		NTS									
GENERAL TOLERANCES (UNLESS SPECIFIED)											
		MM		INCH							
4 PLACES		±		±							
3 PLACES		±		±							
2 PLACES		± 0.2		±							
1 PLACE		±		±							
0 PLACES		±		±							
ANGULAR TOL		± 3.0°									
DRAFT WHERE APPLICABLE MUST REMAIN WITHIN DIMENSIONS				THIRD ANGLE PROJECTION		DRAWING		SERIES		MATERIAL NUMBER	
						A3-SIZE		87758		SEE TABLE	
DOCUMENT STATUS				P1		RELEASE DATE		2021/10/11		11:53:16	
		9		8		7		6		5	
		4		3		2		1			