

Common Mode Noise Filter
NFG0NCN□□□HL3□

Reference Specification

1. Scope

This reference specification applies to Common Mode Noise Filter NFG0NCN Series for differential signal interface in Electronics.

2. Part Numbering

(ex.)

| | | | | | | | | | |
|-----|-----|-----|-----|-----|-----|-----|-----|-----|------|
| NF | G | 0N | C | N | 162 | H | L | 3 | D |
| (1) | (2) | (3) | (4) | (5) | (6) | (7) | (8) | (9) | (10) |

- (1) Common Mode Noise Filter
- (2) Structure G : Monolithic Type
- (3) Dimension
- (4) Type
- (5) Category N : General Use
- (6) Common Mode Insertion Loss Characteristic Resonant Frequency(Typ.)
- (7) Circuit H : Characteristic Impedance 100Ω system
- (8) Features
- (9) Number of Line
- (10) Packaging Code D : Taping / B : Bulk

*Bulk packing also available. (A product is put in the plastic bag under the taping conditions.)

3. Rating

| Customer Part Number | MURATA Part Number | Common Mode Impedance (Ω) at 100MHz | Common Mode Insertion Loss Characteristic (dB Typ.) | | |
|----------------------|--------------------|-------------------------------------|---|--------|---------|
| | | | @800MHz | @1G Hz | @1.6GHz |
| | NFG0NCN162HL3D | 25±25% | 19 | 22 | 29 |

| MURATA Part Number | Rated Current (mA) | Rated Voltage (V(DC)) | Withstanding Voltage (V(DC)) | DC Resistance (Rdc) (Ω) | Insulation Resistance (I.R.) (MΩ min.) | Cut off Frequency (GHz Typ.) |
|--------------------|--------------------|-----------------------|------------------------------|-------------------------|--|------------------------------|
| NFG0NCN162HL3D | 100 | 5 | 12.5 | 1.85Ω±25% | 10 | 4 |

Operating Temperature : -40 to +85°C Storage Temperature : -40 to +85°C

4. Standard Testing Conditions

<Unless otherwise specified>

Temperature : Ordinary Temperature 15 to 35°C
 Humidity : Ordinary Humidity 25 to 85%(RH)

<In case of doubt>

Temperature : 20 ± 2°C
 Humidity : 60 to 70%(RH)
 Atmospheric Pressure : 86 to 106kPa

5. Style and Dimensions

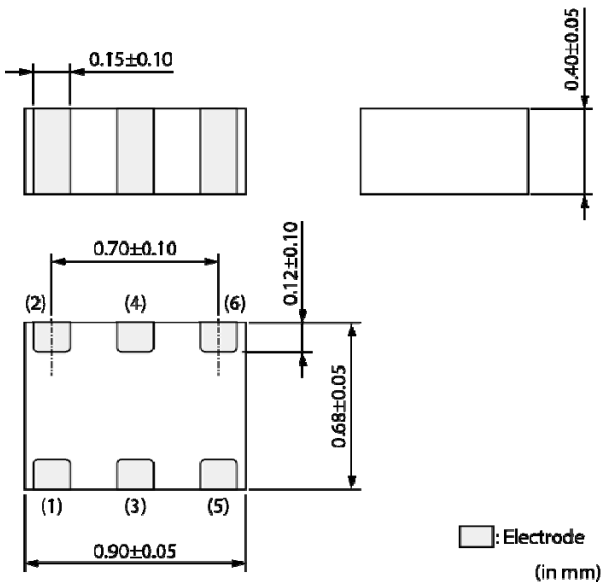

Equivalent Circuits

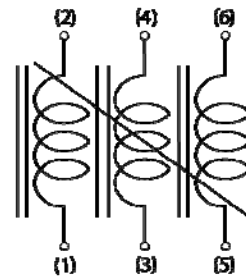

■ Unit Mass(Typical value)
0.00087g

6. Marking

No Marking.

7. Electrical Performance

| No. | Item | Specification | Test Method |
|-----|------------------------------|--------------------------------|--|
| 7.1 | Common Mode Impedance | Meet item 3. | Measuring Frequency : 100MHz (ref.item 10.) Measuring Equipment : KEYSIGHT4291A or the equivalents (In case of doubt in standard condition, the heat treatment(200°C, about 10 minutes)shall be applied. |
| 7.2 | Withstanding Voltage | Products shall not be damaged. | Test Voltage : 2.5 times for Rated Voltage Time : 1 to 5 s Charge Current : 1 mA max.(ref.item 10.) |
| 7.3 | DC Resistance (Rdc) | Meet item 3. | Measuring current : 20mA max.(ref.item 10.) |
| 7.4 | Insulation Resistance (I.R.) | | Measuring voltage : Rated Voltage Measuring time : 1 min max. (ref.item 10.) |

8. Mechanical Performance

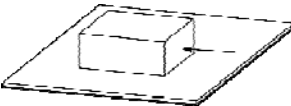
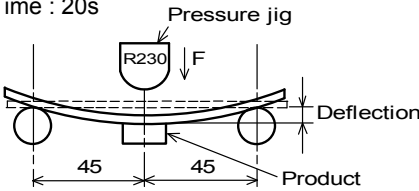
| No. | Item | Specification | Test Method |
|-----|------------------|---|---|
| 8.1 | Bonding Strength | Products shall not be damaged after tested as test method. | It shall be soldered on the 6 Layer substrate. Applying Force: 2N Applying Time : 5s  |
| 8.2 | Bending Strength | | It shall be soldered on the 6 Layer substrate. Test substrate: glass-epoxy substrate (100 mm × 40 mm × 1.0 mm) Deflection : 2mm Speed of Applying Force : 1.0mm/s Keeping Time : 20s  |
| 8.3 | Vibration | Appearance: No damage | It shall be soldered on the 6 Layer substrate. Oscillation Frequency : 10Hz to 2000Hz to 10Hz for 20min Total amplitude 3.0mm or Acceleration amplitude 196 m/s ² whichever is smaller. Testing Time : A period of 2h in each of 3 mutually perpendicular directions.(Total 6h) |
| 8.4 | Solderability | The electrodes shall be at least 95% covered with new solder coating. | Flux : Ethanol solution of rosin,25(wt)% Pre-Heating : 150°C, 60s Solder : Sn-3.0Ag-0.5Cu Solder Temperature : 245°C±3°C Immersion Time : 3s |

9.Environmental Performance

It shall be soldered on the 6 Layer substrate.

| No. | Item | Specification | Test Method | | | | | | | | |
|------------------------------|-------------------|---|--|------------|------------------------------|--------------|------|-----------|----------------------|--------------|--|
| 9.1 | Heat Life | Meet Table 1. Table 1 | Temperature : 85°C±2°C Applying Current : Rated Current Time : 1000h(+48h,-0h) Then measured after exposure in the room condition for 4 to 48 h. | | | | | | | | |
| 9.2 | Cold Resistance | <table border="1" style="width: 100%;"> <tr> <td>Appearance</td> <td>No damaged</td> </tr> <tr> <td>Common Mode Impedance Change</td> <td>Within ± 30%</td> </tr> <tr> <td>I.R.</td> <td>10MΩ min.</td> </tr> <tr> <td>DC Resistance Change</td> <td>Within ± 30%</td> </tr> </table> | Appearance | No damaged | Common Mode Impedance Change | Within ± 30% | I.R. | 10MΩ min. | DC Resistance Change | Within ± 30% | Temperature : -40°C±2°C Time : 1000h(+48h,-0h) Then measured after exposure in the room condition for 4 to 48 h. |
| Appearance | No damaged | | | | | | | | | | |
| Common Mode Impedance Change | Within ± 30% | | | | | | | | | | |
| I.R. | 10MΩ min. | | | | | | | | | | |
| DC Resistance Change | Within ± 30% | | | | | | | | | | |
| 9.3 | Humidity | | Temperature : 40°C±2°C Humidity : 90%(RH) to 95%(RH) Time : 1000h(+48h,-0h) Then measured after exposure in the room condition for 4 to 48 h. | | | | | | | | |
| 9.4 | Temperature Cycle | | 1 cycle : 1 step : -40 °C(+0 °C,-3 °C) /30min(+3min,-0min) 2 step : Ordinary temp. / 3 min max. 3 step : +85 °C(+3 °C,-0 °C) / 30min(+3min,-0min) 4 step : Ordinary temp. / 3 min max. Total of 100 cycles Then measured after exposure in the room condition for 4 to 48 h. | | | | | | | | |

10. Terminal to be Tested.

When measuring and supplying the voltage,the following terminal is applied.

| No. | Item | Terminal to be Tested |
|------|--|-----------------------|
| 10.1 | Common Mode Impedance (Measurement Terminal) | |
| 10.2 | Withstanding Voltage (Measurement Terminal) Insulation Resistance (Measurement Terminal) Heat Life (Supply Terminal) | |
| 10.3 | DC Resistance (Measurement Terminal) | |

11. Measuring method for common mode impedance.

Measured common mode impedance may be included measurement error due to stray capacitance, residual inductance of test fixture.

To correct this error, the common mode impedance should be calculate as follows;

- (1) Measure admittance of the fixture(opened), G_o B_o .
- (2) Measure impedance of the fixture(shorted), R_s X_s .
- (3) Measure admittance of the specimen, G_m B_m .
- (4) Calculate corrected impedance $|Z|$ using the formula below.

$$|Z| = (R_x^2 + X_x^2)^{1/2}$$

Where

$$R_x = \frac{G_m - G_o}{(G_m - G_o)^2 + (B_m - B_o)^2} - R_s$$

$$X_x = \frac{-(B_m - B_o)}{(G_m - G_o)^2 + (B_m - B_o)^2} - X_s$$

12. P.C.B., Flux, Solder and Soldering condition

Test shall be done using P.C.B., Flux, Solder and Soldering condition which are specified in item 16 except the case of being specified special condition.

13. Impedance Frequency Characteristics(Typical)

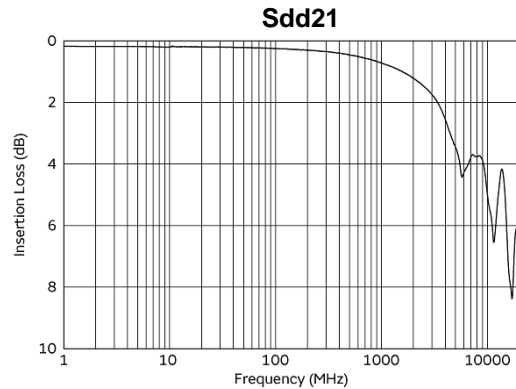
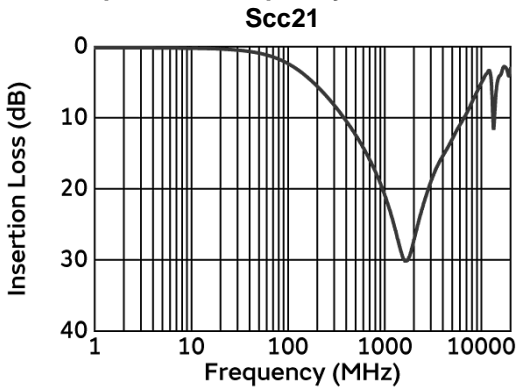

14. Specification of Packaging

14.1 Appearance and Dimensions (8mm-wide, 2mm pitch paper tape)

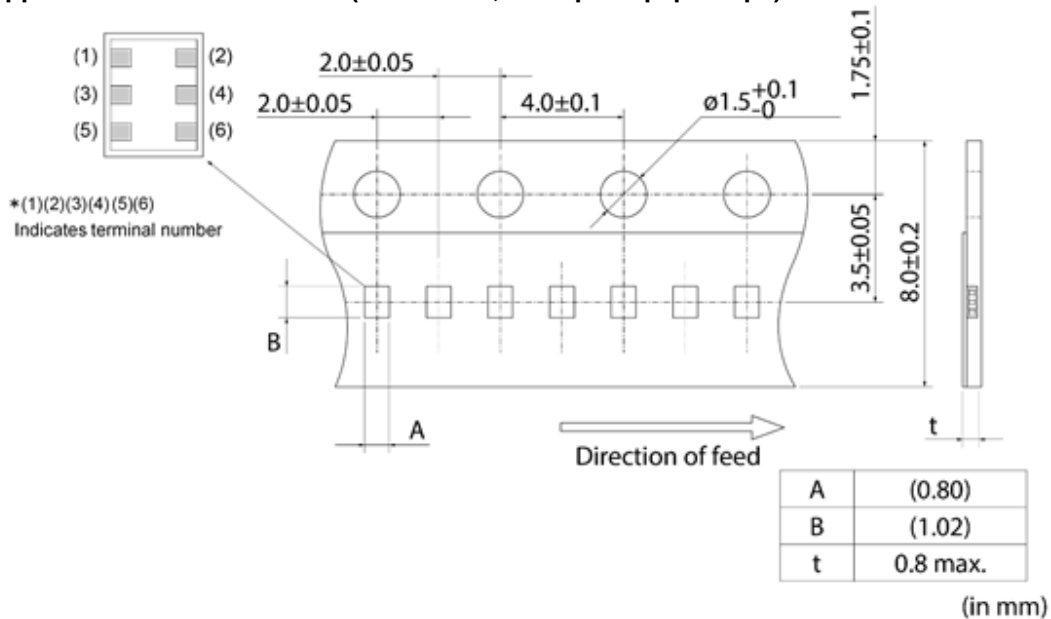

15. ⚠Caution

Limitation of Applications

Please contact us before using our products for the applications listed below which require especially high reliability for the prevention of defects which might directly cause damage to the third party's life, body or property.

- | | |
|-----------------------------------|--|
| (1) Aircraft equipment | (6) Transportation equipment (vehicles, trains, ships, etc.) |
| (2) Aerospace equipment | (7) Traffic signal equipment |
| (3) Undersea equipment | (8) Disaster prevention / crime prevention equipment |
| (4) Power plant control equipment | (9) Data-processing equipment |
| (5) Medical equipment | (10) Applications of similar complexity and / or reliability requirements to the applications listed in the above. |

16. Notice

This product is designed for solder mounting. (reflow soldering only)

Please consult us in advance for applying other mounting method such as conductive adhesive.

16.1 Flux and Solder

| | |
|--------|--|
| Flux | Use rosin-based flux, but not highly acidic flux (with chlorine content exceeding 0.2(wt)%.) Do not use water-soluble flux. |
| Solder | Use Sn-3.0Ag-0.5Cu solder Use of Sn-Zn based solder will deteriorate performance of products. In case of using Sn-Zn based solder, please contact Murata in advance. |

16.2 Assembling

<Thermal Shock>

Pre-heating should be in such a way that the temperature difference between solder and ceramic surface is limited to 100°C MAX. Also cooling into solvent after soldering should be in such a way that the temperature difference is limited to 100°C max.

16.3 Resin coating

The impedance value may change and/or it may affect on the product's performance due to high cure-stress of resin to be used for coating / molding products. So please pay your careful attention when you select resin. In prior to use, please make the reliability evaluation with the product mounted in your application set.

16.4 Attention regarding P.C.B. bending

The following shall be considered when designing and laying out P.C.B.'s.

- (1) P.C.B. shall be designed so that products are not subject to the mechanical stress due to warping the board.

[Products direction]

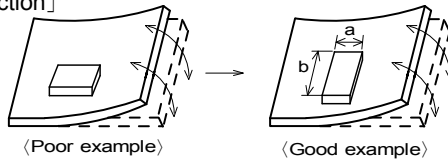

Products shall be location the sideways Direction (Length : a<b) to the machanical Stress.

[Warping direction]

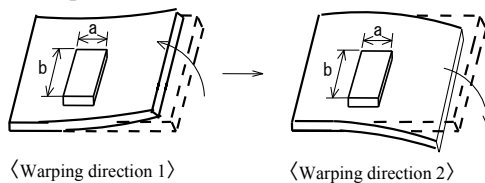

Products(warping direction 1, warping direction 2) shall be located carefully so that products are not subject to the mechanical stress due to warping the board. Because they may be subjected the mechanical stress in order of warping direction 1>warping direction 2.

- (2)Components location on P.C.B. separation.

It is effective to implement the following measures, to reduce stress in separating the board.

It is best to implement all of the following three measures; however, implement as many measures as possible to reduce stress.

| Contents of Measures | Stress Level |
|--|--------------|
| (1) Turn the mounting direction of the component parallel to the board separation surface. | A > D *1 |
| (2) Add slits in the board separation part. | A > B |
| (3) Keep the mounting position of the component away from the board separation surface. | A > C |

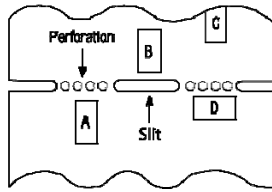

*1 A > D is valid when stress is added vertically to the perforation as with Hand Separation.
If a Cutting Disc is used, stress will be diagonal to the PCB, therefore A > D is invalid.

(3) Mounting Components Near Screw Holes

When a component is mounted near a screw hole, it may be affected by the board deflection that occurs during the tightening of the screw. Mount the component in a position as far away from the screw holes as possible.

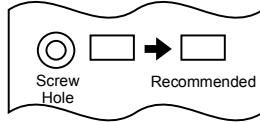

16.5 Attention Regarding P.C.B. Design

< The Arrangement of Products >

P.C.B. shall be designed so that products are far from the portion of perforation.

The portion of perforation shall be designed as narrow as possible, and shall be designed so as not to be applied the stress in the case of P.C.B. separation.

Products shall not be arranged on the line of a series of holes when there are big holes in P.C.B. (Because the stress concentrate on the line of holes.)

< Products Placing >

Support pins shall be set under P.C.B. to prevent causing a warp to P.C.B. during placing the products on the other side of P.C.B.

< P.C.B. Separation >

P.C.B. shall not be separated with hand.
P.C.B. shall be separated with the fixture so as not to cause P.C.B. bending.

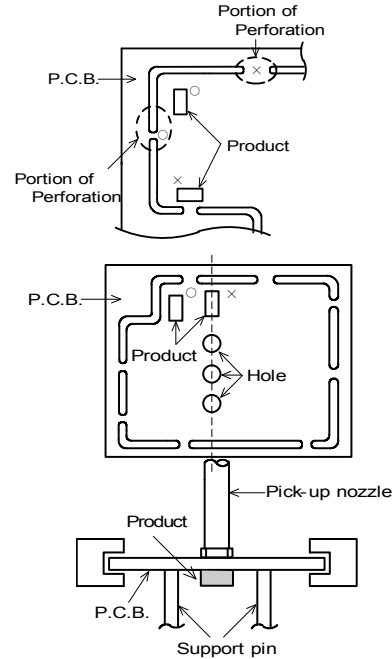

16.6 Attention Regarding P.C.B. Mounting

In case of mounting by use of mounting machine, please choose nozzle which can pick up components of 1005 or 0603 size.

16.7 Standard Land Dimensions

These have been designed for Electric characteristics and solderability. Please follow the recommended patterns. Otherwise, their performance which includes electrical performance or solderability may be affected, or result to "position shift" in soldering process.

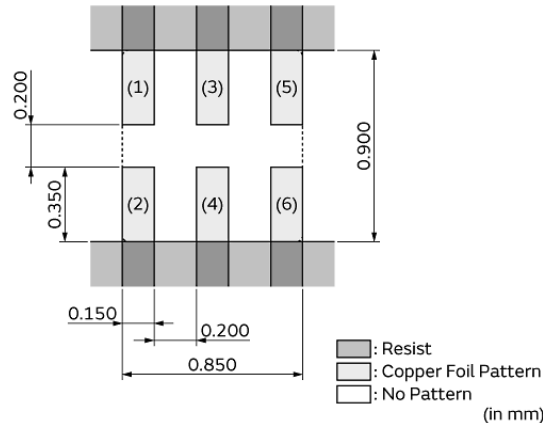

16.8 Soldering(Reflow soldering)

Standard soldering profile and the limit soldering profile is as follows.

The excessive limit soldering conditions may cause leaching of the electrode and / or resulting in the deterioration of product quality.

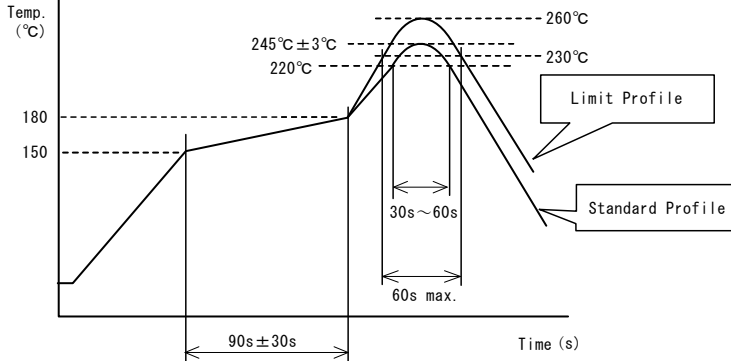

| | Standard Profile | Limit Profile |
|------------------|---------------------|----------------------|
| Pre-heating | 150~180°C、90s±30s | |
| Heating | above 220°C、30s~60s | above 230°C、60s max. |
| Peak temperature | 245±3°C | 260°C、10s |
| Cycle of reflow | 2 times | 2 times |

(1) Standard printing pattern of solder paste

- Standard thickness of the solder paste should be 100 to 150μm.
- Use the solder paste printing pattern of the following figure.
- For the resist and copper foil pattern, use standard land dimensions.
- Use Sn-3.0Ag-0.5Cu solder.

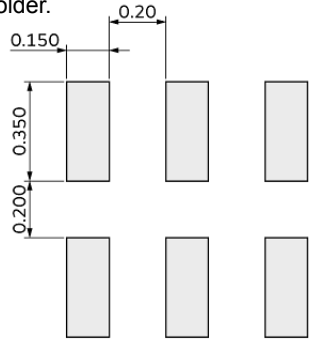

(in mm)

(2) Reworking with Soldering iron

- The following conditions shall be strictly followed when using a soldering iron after being mounted by reflow soldering.
 - Pre-heating: 150°C, 1 min
 - Soldering iron output: 30W max.
 - Tip temperature: 380°C max.
 - Tip diameter: φ3mm max.
 - Soldering time : 3(+1,-0) s.
 - Times : 2times max.
- Do not touch the products directly with the tip of the soldering iron.

(3) Solder Volume

Solder shall be used not to be exceeded the upper limits as shown below.

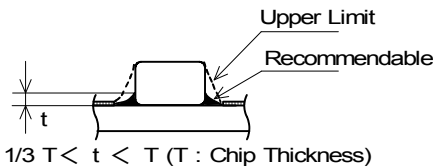

Accordingly increasing the solder volume, the mechanical stress to product is also increased. Excessive solder volume may cause the failure of mechanical or electrical performance.

16.9 Cleaning Conditions

Products shall be cleaned on the following conditions.

- (1) Cleaning temperature shall be limited to 60°C max. (40°C max. for Isopropyl alcohol.)
- (2) Ultrasonic cleaning shall comply with the following conditions, avoiding the resonance phenomenon at the mounted products and P.C.B..
 - Power : 20W/ l max. • Frequency : 28kHz to 40kHz • Time : 5 minutes max.
- (3) Cleaner
 1. Alternative cleaner • Isopropyl alcohol (IPA)
 2. Aqueous agent • PINE ALPHA ST-100S
- (4) There shall be no residual flux and residual cleaner after cleaning.
In the case of using aqueous agent, products shall be dried completely after rinse with de-ionized water in order to remove the cleaner.
- (5) Other cleaning
Please contact us.

16.10 Handling of a substrate

After mounting products on a substrate, do not apply any stress to the product caused by bending or twisting to the substrate when cropping the substrate, inserting and removing a connector from the substrate or tightening screw to the substrate.

Excessive mechanical stress may cause cracking in the product.

Bending

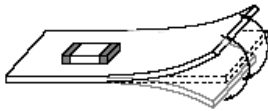

Twisting

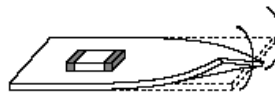
**16.11 Operating Environment**

Do not use this product under the following environmental conditions, on deterioration of the performance, such as insulation resistance may result from the use.

- (1) in the corrodible atmosphere such as acidic gases, alkaline gases, chlorine, sulfur gases, organic gases and etc (the sea breeze, Cl₂, H₂S, NH₃, SO₂, NO₂, etc)
- (2) in the atmosphere where liquid such as organic solvent, may splash on the products.

16.12 Storage Conditions**(1) Storage period**

Use the products within 12 months after delivered.

Solderability should be checked if this period is exceeded.

(2) Storage environment condition

- Products should be stored in the warehouse on the following conditions.

Temperature : -10 to +40°C

Humidity : 15 to 85% relative humidity

No rapid change on temperature and humidity

- Products should not be stored in corrosive gases, such as sulfurous, acid gases, alkaline gases, to prevent the following deterioration.

Poor solderability due to the oxidized electrode.

- Products should be stored on the palette for the prevention of the influence from humidity, dust and so on.
- Products should be stored in the warehouse without heat shock, vibration, direct sunlight and so on.
- Products should be stored under the airtight packaged condition.

(3) Delivery

Care should be taken when transporting or handling product to avoid excessive vibration or mechanical shock.

17.  Note

- (1) Please make sure that your product has been evaluated in view of your specifications with our product being mounted to your product.
- (2) You are requested not to use our product deviating from the agreed specifications.
- (3) The contents of this reference specification are subject to change without advance notice. Please approve our product specifications or transact the approval sheet for product specifications before ordering.