

PL80A

SICK
Sensor Intelligence.



Ordering information

Type	Part no.
PL80A	1003865

Other models and accessories → www.sick.com/

Detailed technical data

Technical specifications

Accessory group	Reflectors
Accessory family	Angular
Description	Rectangular, screw connection
Mounting system type	Screw-on, 2 hole mounting
Ambient operating temperature	-20 °C ... +65 °C
Reflective area	80 mm x 80 mm
Material	PMMA/ABS

Classifications

ECl@ss 5.0	27279203
ECl@ss 5.1.4	27279203
ECl@ss 6.0	27279203
ECl@ss 6.2	27279203
ECl@ss 7.0	27279203
ECl@ss 8.0	27279203
ECl@ss 8.1	27279203
ECl@ss 9.0	27273601
ETIM 5.0	EC002467
ETIM 6.0	EC002467
UNSPSC 16.0901	39111827

Dimensional drawing (Dimensions in mm (inch))

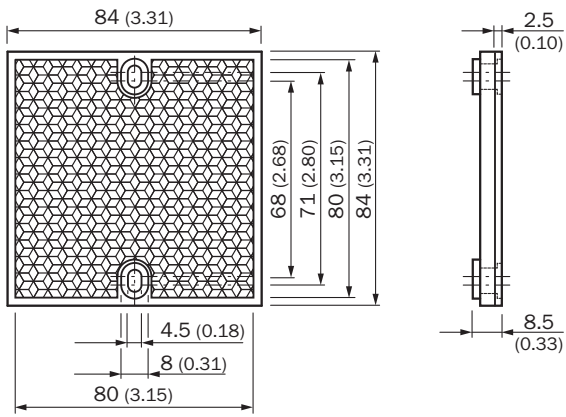

SICK AT A GLANCE

SICK is one of the leading manufacturers of intelligent sensors and sensor solutions for industrial applications. A unique range of products and services creates the perfect basis for controlling processes securely and efficiently, protecting individuals from accidents and preventing damage to the environment.

We have extensive experience in a wide range of industries and understand their processes and requirements. With intelligent sensors, we can deliver exactly what our customers need. In application centers in Europe, Asia and North America, system solutions are tested and optimized in accordance with customer specifications. All this makes us a reliable supplier and development partner.

Comprehensive services complete our offering: SICK LifeTime Services provide support throughout the machine life cycle and ensure safety and productivity.

For us, that is “Sensor Intelligence.”

WORLDWIDE PRESENCE:

Contacts and other locations –www.sick.com