

SURFACE MOUNT SCHOTTKY BARRIER RECTIFIER

VOLTAGE RANGE 200 Volts CURRENT 3.0 Amperes

FEATURES

- * Good for automation insertion
- * Ideal for printed circuit board
- * Reliable low cost construction utilizing molded
- * Glass passivated device
- * Polarity symbols molded on body
- * Mounting position: Any

MECHANICAL DATA

- * Epoxy: Device has UL flammability classification 94V-0

MAXIMUM RATINGS AND ELECTRICAL CHARACTERISTICS

Ratings at 25 °C ambient temperature unless otherwise specified.
resistive or inductive load.



DB-S

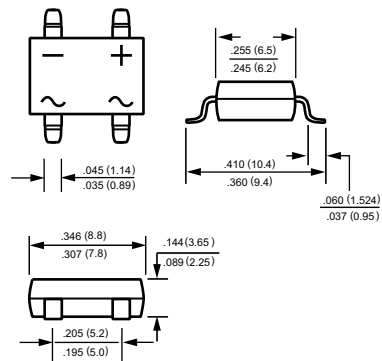

MAXIMUM RATINGS (@ TA=25 °C unless otherwise noted)

RATINGS	SYMBOL	KDB3200S	UNITS
Maximum Recurrent Peak Reverse Voltage	V_{RRM}	200	Volts
Maximum RMS Voltage	V_{RMS}	140	Volts
Maximum DC Blocking Voltage	V_{DC}	200	Volts
Max Avg Forward Rectify Current at Ambient Temp needs To be corrected to Lead Temperature, TL	I_O	3.0	Amps
Peak Forward Surge Current 8.3 ms single half sine-wave superimposed on rated load (JEDEC method)	I_{FSM}	80	Amps
Typical Current Square Time	I^2T	26.5	A ² S
Typical Thermal Resistance (Note 1)	$R_{\theta JA}$	55	°C/W
	$R_{\theta JL}$	17	
Typical Junction Capacitance (Note 2)	C_J	200	pF
Operating Temperature Range	T_J	-55 to + 150	°C
Storage Temperature Range	T_{STG}	-55 to + 150	°C

ELECTRICAL CHARACTERISTICS(@TA=25 °C unless otherwise noted)

CHARACTERISTICS	SYMBOL	KDB3200S	UNITS
Maximum Instantaneous Forward Voltage at 3.0A DC	V_F	.85	Volts
Maximum Average Reverse Current at Rated DC Blocking Voltage	I_R	@ $T_A = 25^\circ\text{C}$	20
		@ $T_A = 100^\circ\text{C}$	4
			uA
			mA

NOTES : 1. Thermal Resistance : Mounted on PCB.
2. Measured at 1 MHz and applied reverse voltage of 4.0 volts.

2022-09/97
REV:B

RATING AND CHARACTERISTICS CURVES (KDB3200S)

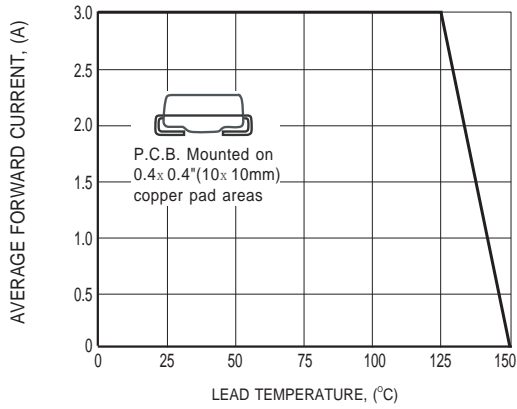

FIG.1 TYPICAL FORWARD CURRENT DERATING CURVE

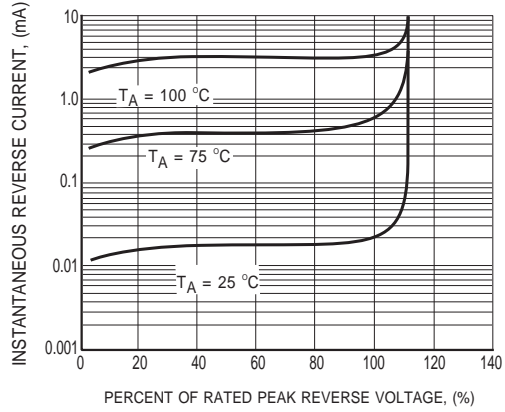

FIG.2 MAXIMUM REVERSE CHARACTERISTICS

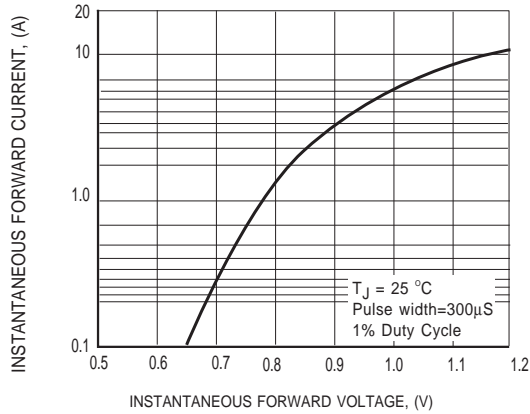

FIG.3 MAXIMUM INSTANTANEOUS FORWARD CHARACTERISTICS

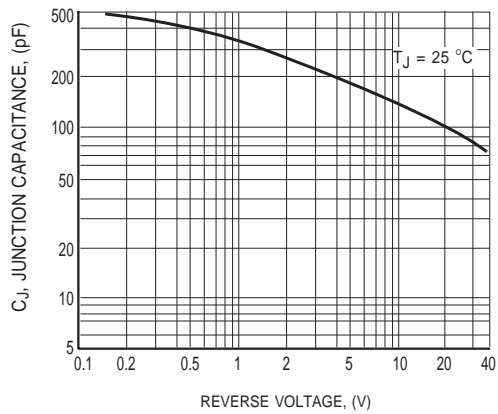

FIG.4 TYPICAL JUNCTION CAPACITANCE

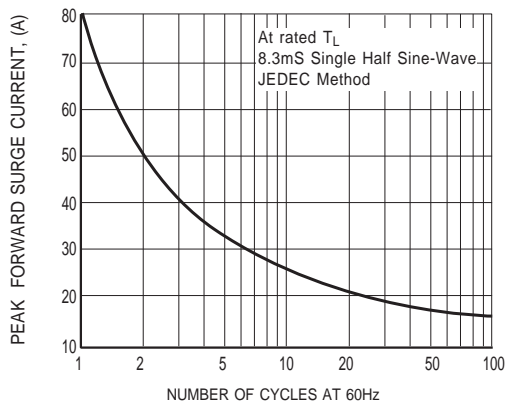
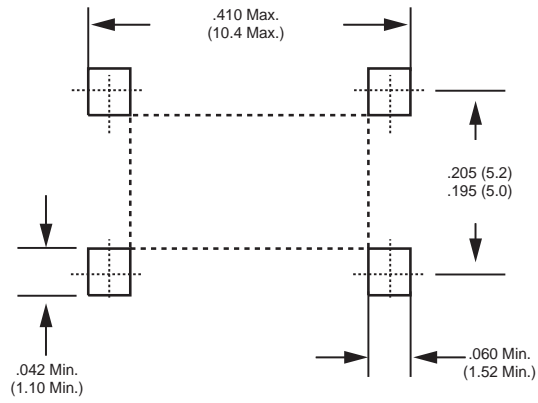

FIG.5 MAXIMUM NON-REPETITIVE FORWARD SURGE CURRENT

Mounting Pad Layout



Dimensions in inches and (millimeters)

Marking Description

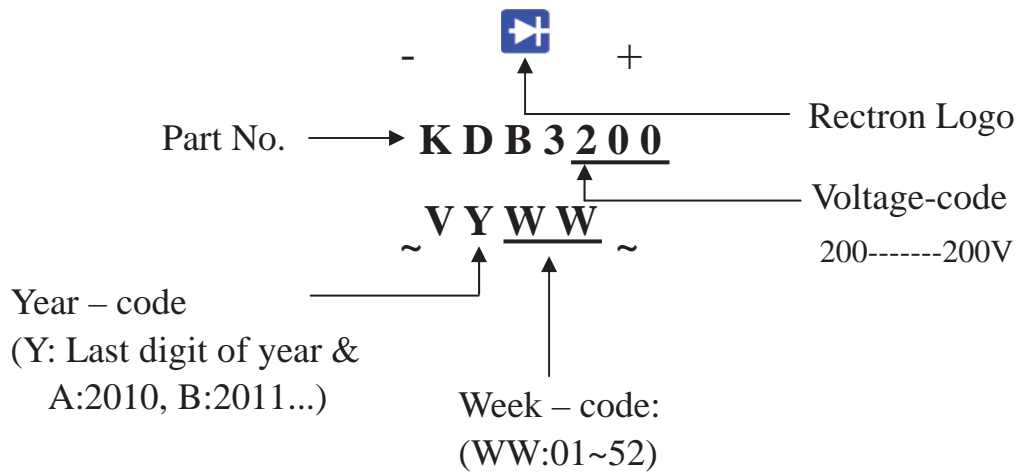

PACKAGING OF DIODE AND BRIDGE RECTIFIERS

REEL PACK

PACKAGE	PACKING CODE	EA PER REEL	EA PER INNER BOX	COMPONENT SPACE (mm)	TAPE SPACE (mm)	REEL DIA (mm)	CARTON SIZE (mm)	EA PER CARTON	GROSS WEIGHT(Kg)
DB-S	-T/W	1,000	1,000	9.5	52	330	360*355*360	8,000	9.8

DISCLAIMER NOTICE

Rectron Inc reserves the right to make changes without notice to any product specification herein, to make corrections, modifications, enhancements or other changes. Rectron Inc or anyone on its behalf assumes no responsibility or liability for any errors or inaccuracies. Data sheet specifications and its information contained are intended to provide a product description only. "Typical" parameters which may be included on RECTRON data sheets and/ or specifications can and do vary in different applications and actual performance may vary over time. Rectron Inc does not assume any liability arising out of the application or use of any product or circuit.

Rectron products are not designed, intended or authorized for use in medical, life-saving implant or other applications intended for life-sustaining or other related applications where a failure or malfunction of component or circuitry may directly or indirectly cause injury or threaten a life without expressed written approval of Rectron Inc. Customers using or selling Rectron components for use in such applications do so at their own risk and shall agree to fully indemnify Rectron Inc and its subsidiaries harmless against all claims, damages and expenditures.