



## SPECIFICATION FOR APPROVAL

Customer : \_\_\_\_\_

Description : DC FAN \_\_\_\_\_

Customer Part No. NA \_\_\_\_\_ REV. : \_\_\_\_\_

Delta Model No. : THB2048HG-01 \_\_\_\_\_ REV. : 00 \_\_\_\_\_

Sample Issue No. : \_\_\_\_\_

Sample Issue Date : OCT.27.2020 \_\_\_\_\_

PLEASE SEND ONE COPY OF THIS SPECIFICATION BACK AFTER YOU SIGNED APPROVAL FOR PRODUCTION PRE-ARRANGMENT.

APPROVED BY:

DATE :

DELTA ELECTRONICS, INC.  
TAOYUAN PLANT  
252, SHANGYING ROAD, GUIZHAN INDUSTRIAL ZONE,  
TAOYUAN CITY 33341, TAIWAN  
TEL:886-(0)3-3591968  
FAX:886-(0)3-3591991



Delta Electronics, Inc.

252, SHANGYING ROAD, GUIZHAN INDUSTRIAL ZONE, TEL : 886-(0)3-3591968

TAOYUAN CITY 33341, TAIWAN

FAX : 886-(0)3-3591991

## STATEMENT OF DEVIATION

NONE

DESCRIPTION:

Delta Electronics, Inc.  
252, SHANGYING ROAD, GUISHAN INDUSTRIAL ZONE,  
TAOYUAN CITY 33341, TAIWAN

TEL : 886-(0)3-3591968  
FAX : 886-(0)3-3591991

## Specification For Approval

Customer :

Description : DC FAN

Customer P/N :

rev. :

Delta model no. : THB2048HG-01

Delta Safety Model No.: THB2048HG-01

Sample revision. : 00

Issue no.:

Sample issue date : OCT.26.2020

Quantity :

### 1. SCOPE:

THIS SPECIFICATION DEFINES THE ELECTRICAL AND MECHANICAL CHARACTERISTICS OF THE DC BRUSHLESS AXIAL FLOW FAN.

### 2. CHARACTERS:

ITEM	DESCRIPTION
RATED VOLTAGE	48.0 VDC
OPERATION VOLTAGE	36.0-72.0 VDC
INPUT CURRENT(AVG.)	3.50 (4.20 MAX.) A (SAFETY CURRENT ON SAFETY LABEL : 8.50A)
INPUT POWER(AVG.)	168.00 (201.60 MAX.) W
INPUT POWER(TYP.) (UNDER BACK PRESSURE)	360W
SPEED	6400±10%RPM
MAX. AIR FLOW (AT ZERO STATIC PRESSURE)	22.31 (MIN. 20.08) M3 /MIN. 787.75 (MIN. 708.98) CFM
MAX. AIR PRESSURE (AT ZERO AIRFLOW)	93.08 (MIN. 75.39) mmH2O 3.665 (MIN. 2.968) inchH2O
ACOUSTICAL NOISE (AVG.)	75.5 (MAX. 79.5) dB-A
INSULATION TYPE	UL: CLASS A
INSULATION STRENGTH	10 MEG OHM MIN. AT 500 VDC (BETWEEN FRAME AND (+) TERMINAL)
DIELECTRIC STRENGTH	5 mA MAX. AT 500 VAC 50/60 Hz ONE MINUTE, (BETWEEN FRAME AND (+) TERMINAL)

(continued)

PAGE 1

PART NO:

DELTA MODEL: THB2048HG-01

LIFE EXPECTANCE (L10) AT LABEL VOLTAGE	70,000 HOURS CONTINUOUS OPERATION AT 40 °C WITH 15 ~ 65 %RH.
ROTATION	CLOCKWISE VIEW FROM NAME PLATE SIDE
LOCKED CURRENT SHUT DOWN	THE CURRENT WILL SHUT DOWN, WHEN ROTOR LOCKED AND FIXED.

NOTES:

1. ALL READINGS ARE MEASURED AFTER STABLY WARMING UP THROUGH 10 MINUTES.
2. STANDARD AIR PROPERTY IS AIR AT (Td) 25°C TEMPERATURE, (RH) 65% RELATIVE HUMIDITY , AND (Pb) 760 mmHg BAROMETRIC PRESSURE.
3. THE VALUES WRITTEN IN PARENS , ( ), ARE LIMITED SPEC.
4. ACOUSTICAL NOISE MEASURING CONDITION:

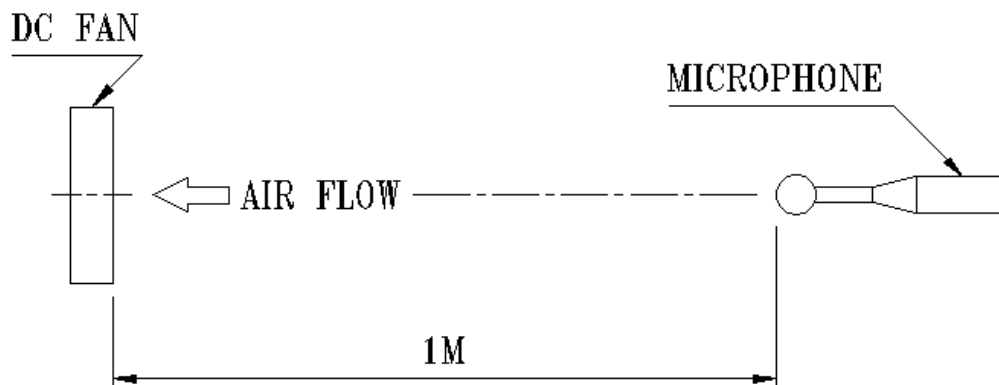

NOISE IS MEASURED AT RATED VOLTAGE IN FREE AIR IN ANECHOIC CHAMBER WITH B & K SOUND LEVEL METER WITH MICROPHONE AT A DISTANCE OF ONE METER FROM THE FAN INTAKE.

---

PART NO:

---

DELTA MODEL: THB2048HG-01

---

3. MECHANICAL:

- 3-1. DIMENSIONS----- SEE DIMENSIONS DRAWING
- 3-2. FRAME----- AL
- 3-3. IMPELLER----- PLASTIC BLACK UL: 94V-0(SECONDARY MATERIALS NOT ALLOWED)
- 3-4. BEARING SYSTEM----- TWO BALL BEARINGS
- 3-5. WEIGHT----- 911 GRAMS
- 3-6. ROTOR WEIGHT-----299 GRAMS
- 3-7. CORROSION PROTECTION-----ADD GLUE ON PAD OF PCBA

4. ENVIRONMENTAL:

- 4-1. OPERATING TEMPERATURE----- -20 TO +75 DEGREE C
- 4-2. STORAGE TEMPERATURE----- -40 TO +75 DEGREE C
- 4-3. OPERATING HUMIDITY----- 5 TO 95 % RH
- 4-4. STORAGE HUMIDITY----- 5 TO 95 % RH

5. PROTECTION:

- 5-1. LOCKED ROTOR PROTECTION  
IMPEDANCE OF MOTOR WINDING PROTECTS MOTOR FROM FIRE IN 96 HOURS OF LOCKED ROTOR CONDITION AT THE RATED VOLTAGE.
- 5-2. POLARITY PROTECTION  
BE CAPABLE OF WITHSTANDING IF REVERSE CONNECTION FOR POSITIVE AND NEGATIVE LEADS.

6. RE OZONE DEPLETING SUBSTANCES:

- 6-1. NO CONTAINING PBBs, PBBOs, CFCs, PBBEs, PBDPEs AND HCFCs.

7. PRODUCTION LOCATION

- 7-1. PRODUCTS WILL BE PRODUCED IN CHINA OR THAILAND .

PART NO:

DELTA MODEL: THB2048HG-01

8. P & Q CURVE:

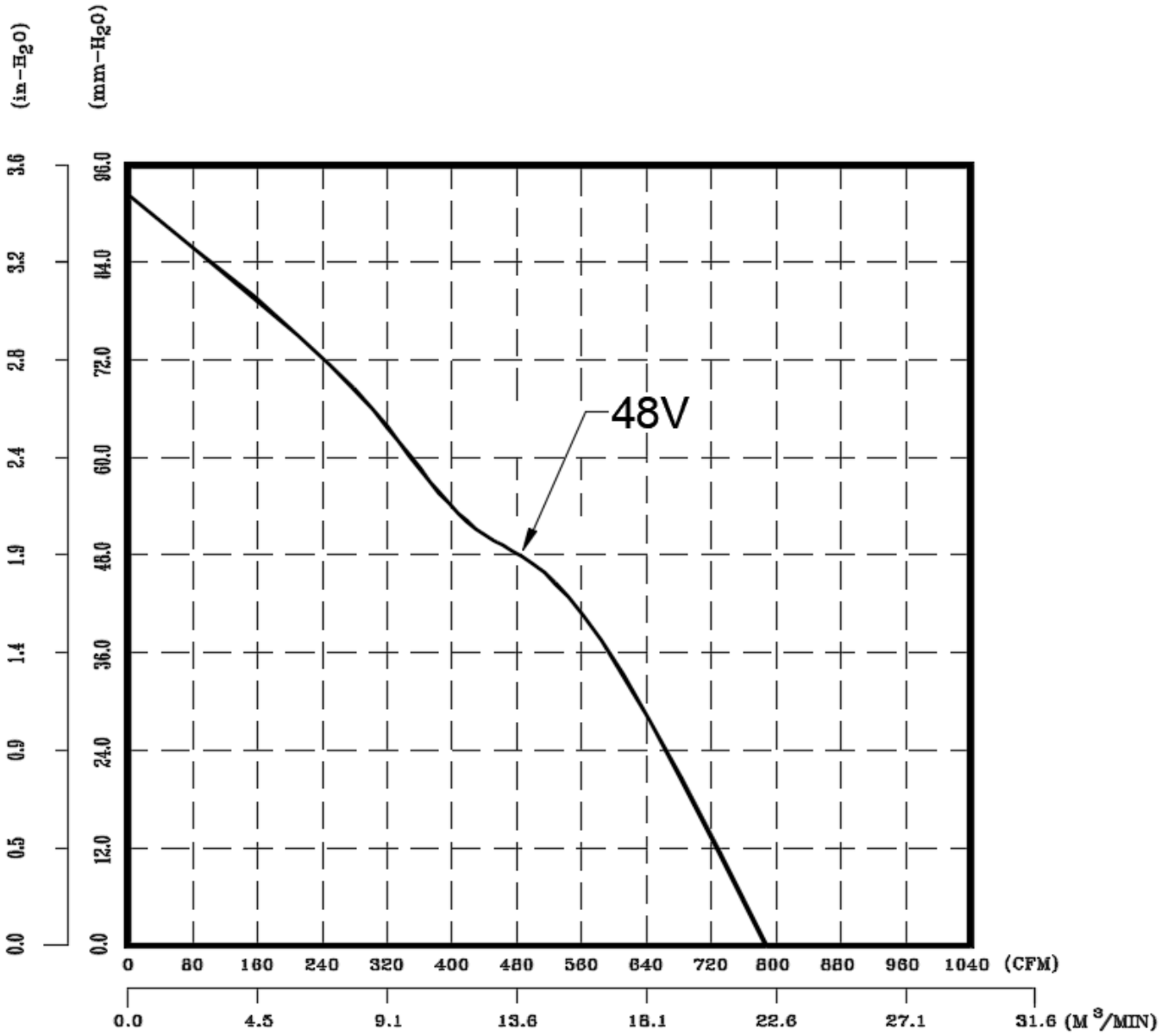

\*TEST CONDITION: INPUT VOLTAGE-----OPERATION VOLTAGE  
TEMPERATURE-----ROOM TEMPERATURE  
HUMIDITY-----65%RH

PART NO:

DELTA MODEL: THB2048HG-01

9. DIMENSION DRAWING:

LABEL:

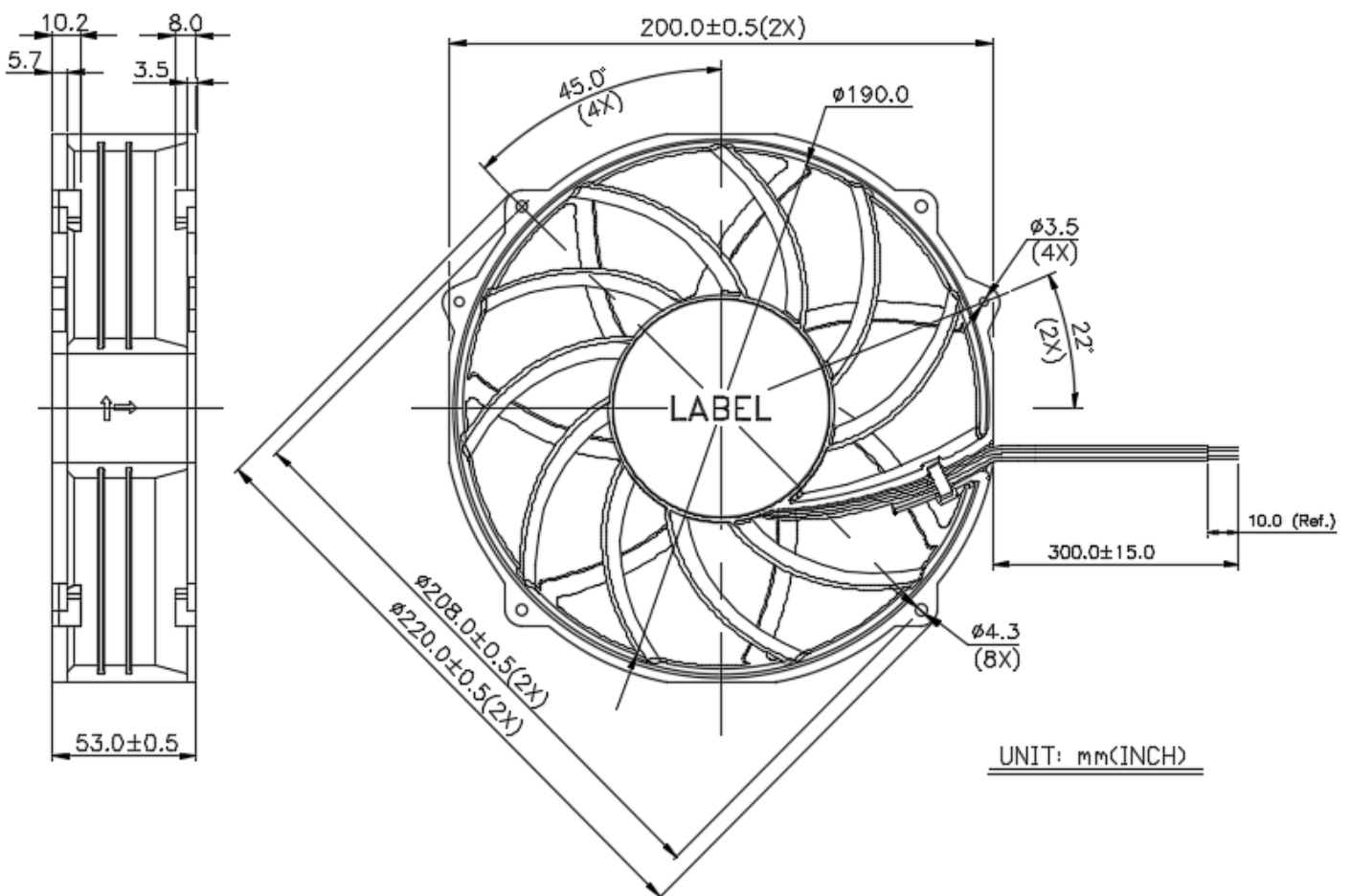

NOTE:

1.PIN ASSIGNMENT:

- PIN 1: RED WIRE----(+)
  - PIN 2: YELLOW WIRE----(PWM)
  - PIN 3: BLUE WIRE----(FOO)
  - PIN 4: BLACK WIRE----(-)
- LEAD WIRE: UL1430 AWG#16  
LEAD WIRE: UL1430 AWG#22  
LEAD WIRE: UL1430 AWG#22  
LEAD WIRE: UL1430 AWG#16

2.THIS PRODUCT IS RoHS COMPLIANT.



10. FREQUENCY GENERATOR (FG) SIGNAL:

1. OUTPUT CIRCUIT - OPEN COLLECTOR MODE:

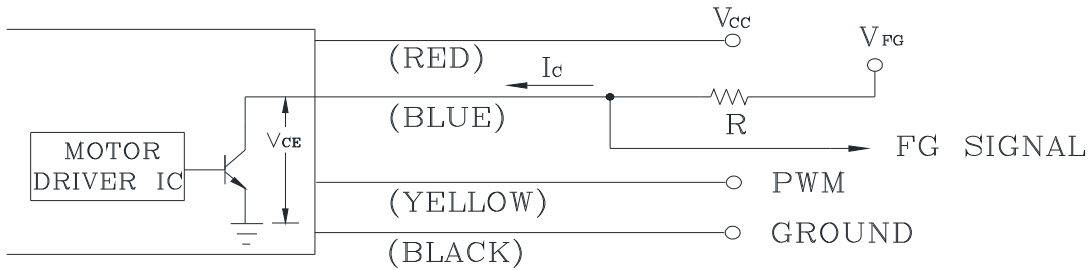

CAUTION: THE FG SIGNAL LEAD WIRE MUST BE KEPT AWAY FROM "+" LEAD WIRE & "-" LEAD WIRE.

2. SPECIFICATION:

$$V_{FG} = 72.0 \text{ V MAX.} \quad I_C = 5\text{mA MAX.}$$

$$V_{CE} (\text{sat}) = 0.5\text{V MAX.} \quad R \geq V_{FG} / I_C$$

3. FREQUENCY GENERATOR WAVEFORM:

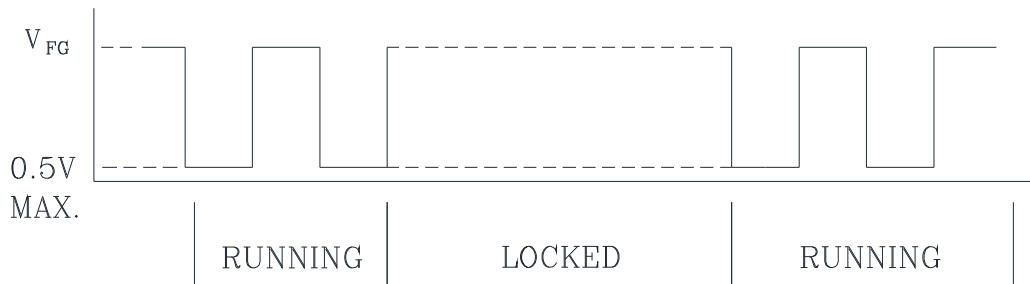

2 PULSES PER ROTATION

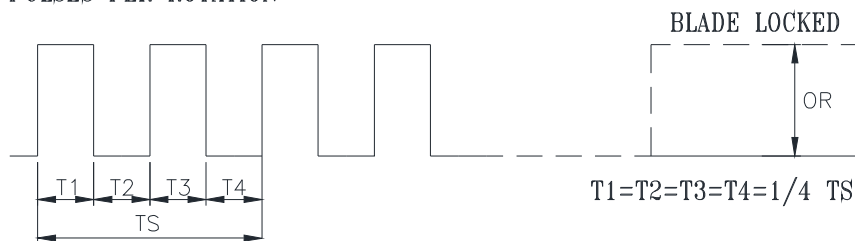

N=RPM

TS=60/N(SEC)

\*VOLTAGE LEVEL AFTER BLADE LOCKED

\*4POLES

11. PWM CONTROL SIGNAL:

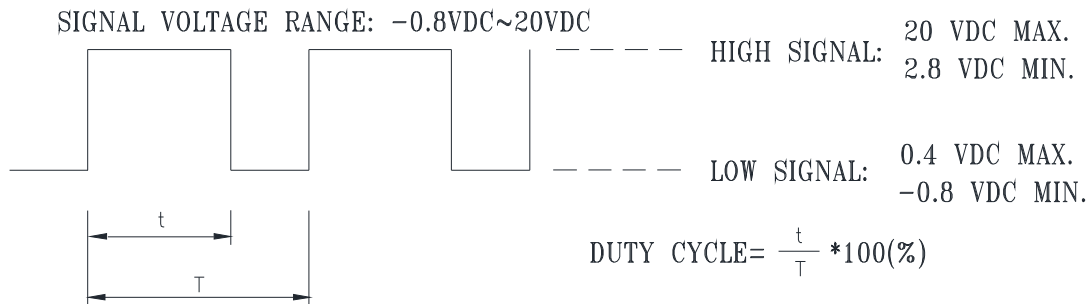

- \*THE PREFERRED OPERATING POINT FOR THE FAN IS 1KHz.
- \*THE FREQUENCY FOR CONTROL SIGNAL OF THE FAN SHALL BE ABLE TO ACCEPT A 600Hz~30KHz.
- \*AT 100% DUTY CYCLE & 48VDC, THE ROTOR WILL SPIN AT MAXIMUM SPEED.
- \*AT 0% DUTY CYCLE & 48VDC, THE ROTOR WILL STOP.
- \*WITH CONTROL SIGNAL LEAD DISCONNECTED, THE FAN WILL SPIN AT MAXIMUM SPEED.
- \*AT 48VDC 1KHz 30% DUTY CYCLE, THE FAN WILL BE ABLE TO START FROM A DEAD STOP .

12. SPEED VS PWM CONTROL SIGNAL: (AT 48VDC & PWM F=1KHz & TEMP=25 DEG.C)

DUTY CYCLE (%)	SPEED RPM (REF.)	CURRENT (A) TYP.
95-100	6400±10%	3.50
50	3300±10%	0.54
10-20	1200±300	0.09
0	0	0.02

13. PWM CONTROL LEAD WIRE INPUT IMPEDANCE:

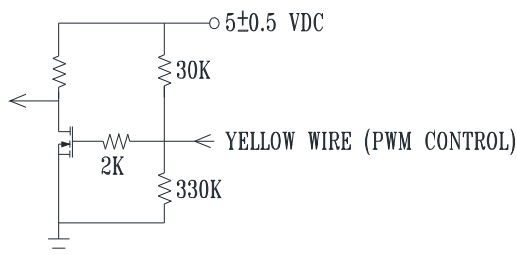

- 13-1. THE FAN SPEED WILL DEFAULT TO MAXIMUM WHEN THE SPEED CONTROL INPUT IS LEFT UNCONNECTED.

PART NO: 32030286

DELTA MODEL: THB2048HG-01CZY

Fan Characteristics Informations for Reference

1. PQ of Duty

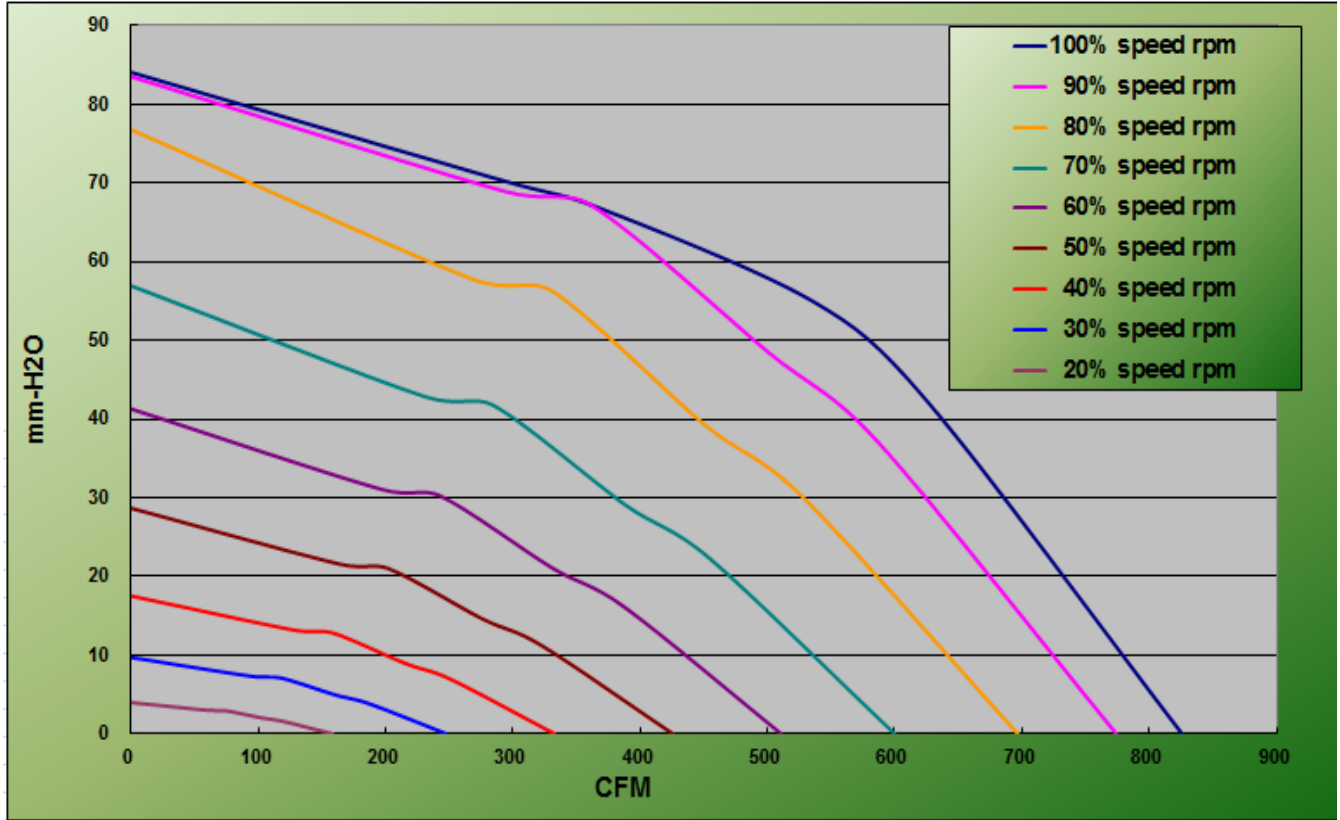

2. Duty vs RPM

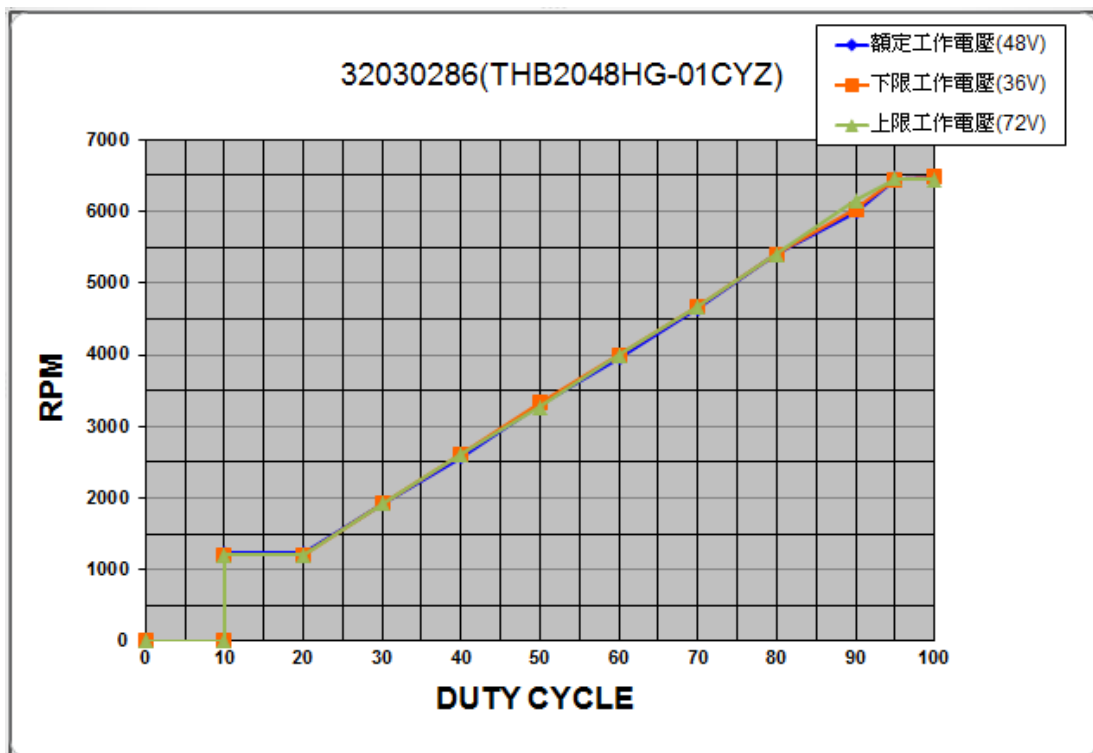

PART NO: 32030286

DELTA MODEL: THB2048HG-01CZY

Fan Characteristics Informations for Reference

3. PQ vs Watt of Voltage

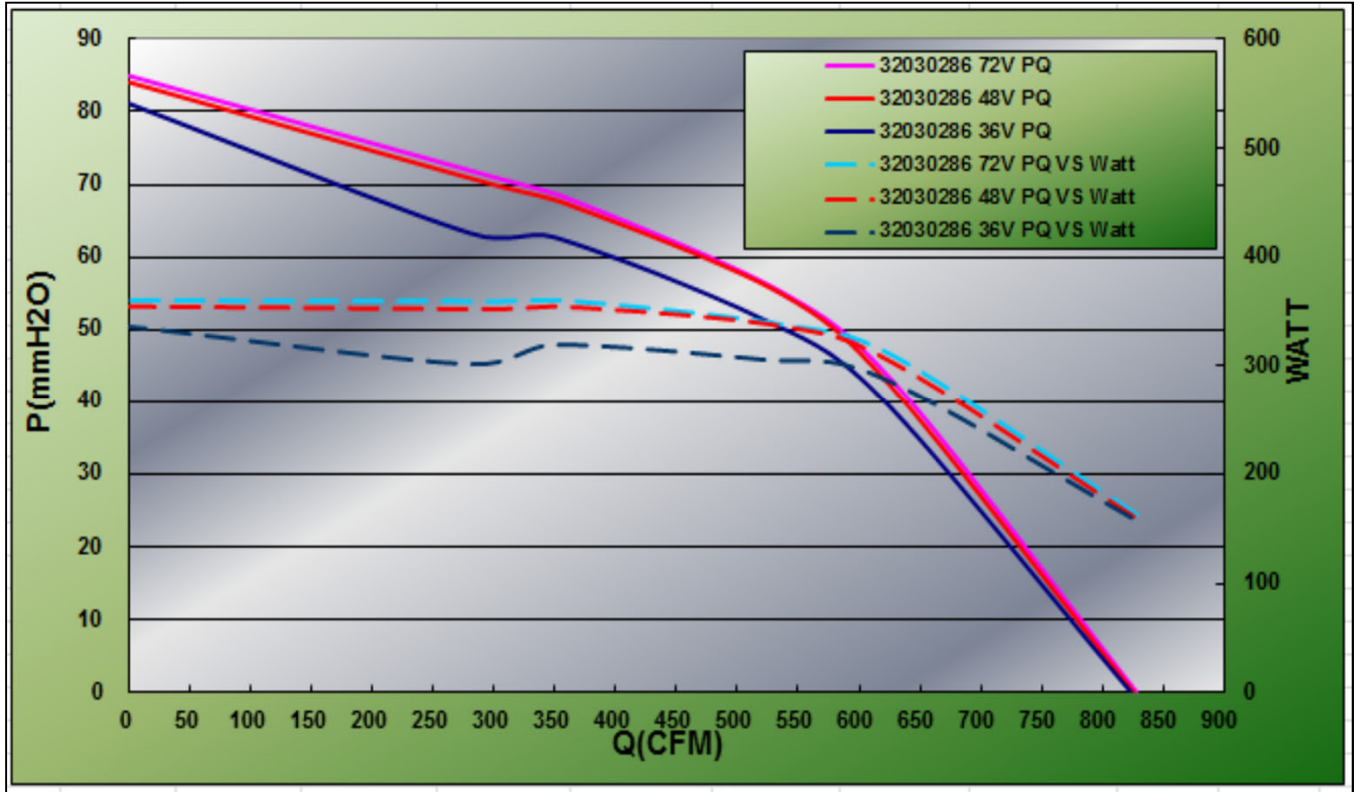

4. RPM vs Watt of Voltage

佔空比	額定工作電壓(48V)		下限工作電壓(36V)		上限工作電壓(72V)	
	轉速(RPM)	電流(A)	轉速(RPM)	電流(A)	轉速(RPM)	電流(A)
0%	0	0.02	0	0.02	0	0.02
10%	1230	0.09	1200	0.09	1200	0.09
20%	1230	0.09	1200	0.09	1200	0.09
30%	1920	0.17	1920	0.20	1920	0.15
40%	2580	0.31	2610	0.40	2610	0.24
50%	3300	0.54	3330	0.70	3270	0.40
60%	3960	0.87	3990	1.17	3990	0.65
70%	4650	1.40	4680	1.83	4680	0.98
80%	5400	2.10	5400	2.69	5403	1.44
90%	6000	2.98	6030	3.91	6150	2.08
100%	6465	3.50	6480	4.72	6450	2.42

Above the current value of 10% tolerance

---

**PART NO: 32030286**

---

**DELTA MODEL: THB2048HG-01CYZ**

---

Fan Characteristics Informations for Reference

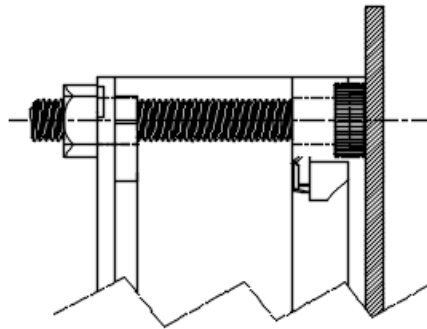
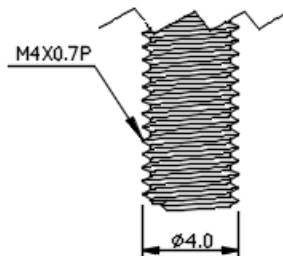
**5. FRAME TYPE OF SCREW TORQUE**MOUNTING DRAWINGMECHANICAL SCREW

<b>MOUNTING HOLE DIAMETER</b>	<b>SCREW TYPE</b>	<b>SCREW SPEC.</b>	<b>RECOMMENDED MAX. TORQUE(kgf-cm)</b>
<b>ø4.3</b>	<b>MECHANICAL</b>	<b>M4x0.7</b>	<b>10.0±10%</b>

NOTE:

1. FLANGE TYPE.
2. MECHANICAL SCREW ACCORDING TO JIS B 0205.



## ***Application Notice***

- 1. Delta will not guarantee the performance of the products if the application condition falls outside the parameters set forth in the specification.**
- 2. A written request should be submitted to Delta prior to approval if deviation from this specification is required.**
- 3. Please exercise caution when handling fans. Damage may be caused when pressure is applied to the impeller, if the fans are handled by the lead wires, or if the fan was hard-dropped to the production floor.**
- 4. Except as pertains to some special designs, there is no guarantee that the products will be free from any such safety problems or failures as caused by the introduction of powder, droplets of water or encroachment of insect into the hub.**
- 5. The above-mentioned conditions are representative of some unique examples and viewed as the first point of reference prior to all other information.**
- 6. It is very important to establish the correct polarity before connecting the fan to the power source. Positive (+) and Negative (-). Damage may be caused to the fans if connection is with reverse polarity, if there is no foolproof method to protect against such error specifically mentioned in this spec.**
- 7. Delta fans without special protection are not suitable where any corrosive fluids are introduced to their environment.**
- 8. Please ensure all fans are stored according to the storage temperature limits specified. Do not store fans in a high humidity environment. We highly recommend performance testing is conducted before shipping, if the fans have been stored over 6 months.**
- 9. Not all fans are provided with the Lock Rotor Protection feature. If you impair the rotation of the impeller for the fans that do not have this function, the performance of those fans will lead to failure.**
- 10. Please be cautious when mounting the fan. Incorrect mounting of fans may cause excess resonance, vibration and subsequent noise.**
- 11. It is important to consider safety when testing the fans. A suitable fan guard should be fitted to the fan to guard against any potential for personal injury.**
- 12. Except where specifically stated, all tests are carried out at room (ambient) temperature and relative humidity conditions of 25°C, 65% RH. The test value is only for fan performance itself.**
- 13. Be certain to connect an “ 4.7μF or greater” capacitor to the fan externally when the application calls for using multiple fans in parallel, to avoid any unstable power.**