

**SM4F10A-MS THRU SM4F170A-MS
SM4F10CA-MS THRU SM4F85CA-MS**

List

List..... 1

Package outline..... 2

Features..... 2

Mechanical data..... 2

Maximum ratings 2

Electrical characteristics..... 3

Rating and characteristic curves..... 4

Pinning information..... 5

Marking..... 5

Suggested solder pad layout..... 5

Packing information..... 6

Reel packing..... 7

Suggested thermal profiles for soldering processes..... 7

High reliability test capabilities..... 8

SM4F10A-MS THRU SM4F170A-MS SM4F10CA-MS THRU SM4F85CA-MS

400W Surface Mount Unidirectional and Bidirectional Transient Voltage Suppressors Diodes 10V-170V

Features

- Unidirectional and Bidirectional
- Stand-off voltage range: from 10V to 170V
- 400W peak pulse power capability with a 10/1000µs waveform, repetition rate (duty cycle): 0.01%
- Low profile surface mounted application in order to optimize board space
- Excellent clamping capability
- Low incremental surge resistance
- Glass passivated chip junction
- Lead-free parts meet RoHS requirements
- Suffix "-H" indicates Halogen-free part, ex. SM4F10A-MS-H

Mechanical data

- Epoxy : UL94-V0 rated flame retardant
- Case : Molded plastic, SOD-123S/MINI SMA
- Terminals :Plated terminals, solderable per MIL-STD-750, Method 2026
- Polarity : Color band denoted cathode except bidirectional
- Mounting Position : Any
- Weight : Approximated 0.0155 gram

Package outline

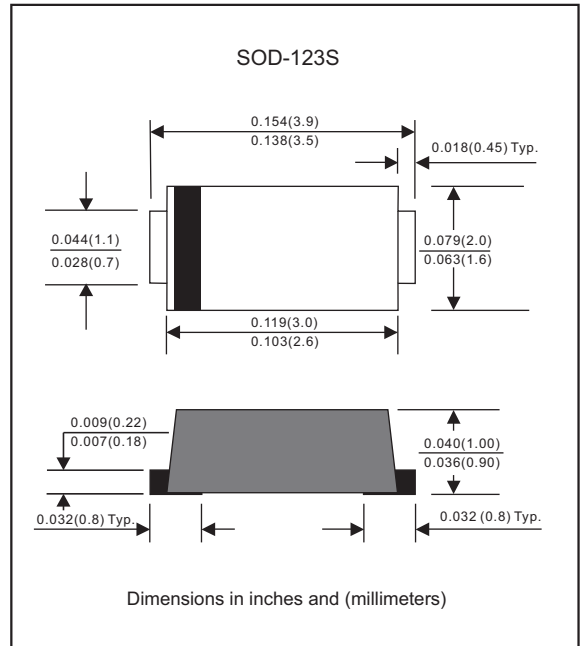

Maximum ratings (AT T_A=25°C unless otherwise noted)

Parameter	Conditions	Symbol	Value	Unit
Peak power dissipation	Peak pulse power dissipation at T _A =25°C by 10x1000µs (Note 1)	P _{PPM}	400	W
Steady state power dissipation	at T _L =75°C (Note 2)	P _{M(AV)}	1.0	W
Peak forward surge current	8.3ms single half sine-wave (Note 3)	I _{FSM}	40	A
Maximum instantaneous forward voltage	at I _F =12A For uni-directional types only	V _F	3.5	V
Typical thermal resistance	Junction to ambient	R _{θJA}	65	°C/W
Typical thermal resistance	Junction to case	R _{θJC}	35	°C/W
Typical thermal resistance	Junction to lead	R _{θJL}	24	°C/W
Operating junction temperature range		T _J	-55 to +150	°C
Storage temperature range		T _{STG}	-65 to +175	°C

Notes 1: Non-repetitive current pulse, per Fig. 2 and derated above T_A=25°C per Fig. 1

2: Mounted on copper pad area of 0.2"x0.2" (5.0x5.0 mm) per Fig. 5

3. Measured on 8.3 ms single half sine-wave or equivalent square wave, duty cycle=4 pulses per minute maximum

Electrical characteristics (at $T_A=25^\circ\text{C}$ unless otherwise noted)

Part No. (Uni)	Part No. (Bi)	Reverse Stand-off Voltage	Breakdown Voltage VBR @ IT		Test Current IT	Maximum Clamping Voltage @ IPP		Maximum Reverse Leakage Current IR@VRWM	Marking Code		
			VRWM	VBR Min		VBR Max	VC		IPP	Uni	Bi
			Volts	Volts		Volts	Volts		A		
SM4F10A-MS	SM4F10CA-MS	10	11.1	12.3	1.0	17.0	23.5	5	4KX	4AX	
SM4F11A-MS	SM4F11CA-MS	11	12.2	13.5	1.0	18.2	21.9	5	4KZ	4AZ	
SM4F12A-MS	SM4F12CA-MS	12	13.3	14.7	1.0	19.9	20.1	5	4LE	4BE	
SM4F13A-MS	SM4F13CA-MS	13	14.4	15.9	1.0	21.5	18.6	5	4LG	4BG	
SM4F14A-MS	SM4F14CA-MS	14	15.6	17.2	1.0	23.2	17.2	5	4LK	4BK	
SM4F15A-MS	SM4F15CA-MS	15	16.7	18.5	1.0	24.4	16.3	5	4LM	4BM	
SM4F16A-MS	SM4F16CA-MS	16	17.8	19.7	1.0	26.0	15.3	5	4LP	4BP	
SM4F17A-MS	SM4F17CA-MS	17	18.9	20.9	1.0	27.6	14.4	5	4LR	4BR	
SM4F18A-MS	SM4F18CA-MS	18	20.0	22.1	1.0	29.2	13.6	5	4LT	4BT	
SM4F20A-MS	SM4F20CA-MS	20	22.2	24.5	1.0	32.4	12.3	5	4LV	4BV	
SM4F22A-MS	SM4F22CA-MS	22	24.4	26.9	1.0	35.5	11.2	5	4LX	4BX	
SM4F24A-MS	SM4F24CA-MS	24	26.7	29.5	1.0	38.9	10.2	5	4LZ	4BZ	
SM4F26A-MS	SM4F26CA-MS	26	28.9	31.9	1.0	42.1	9.5	5	4ME	4CE	
SM4F28A-MS	SM4F28CA-MS	28	31.1	34.4	1.0	45.4	8.8	5	4MG	4CG	
SM4F30A-MS	SM4F30CA-MS	30	33.3	36.8	1.0	48.4	8.2	5	4MK	4CK	
SM4F33A-MS	SM4F33CA-MS	33	36.7	40.6	1.0	53.3	7.5	5	4MM	4CM	
SM4F36A-MS	SM4F36CA-MS	36	40.0	44.2	1.0	58.1	6.8	5	4MP	4CP	
SM4F40A-MS	SM4F40CA-MS	40	44.4	49.1	1.0	64.5	6.2	5	4MR	4CR	
SM4F43A-MS	SM4F43CA-MS	43	47.8	52.8	1.0	69.4	5.7	5	4MT	4CT	
SM4F45A-MS	SM4F45CA-MS	45	50.0	55.3	1.0	72.7	5.5	5	4MV	4CV	
SM4F48A-MS	SM4F48CA-MS	48	53.3	58.9	1.0	77.4	5.1	5	4MX	4CX	
SM4F51A-MS	SM4F51CA-MS	51	56.7	62.7	1.0	82.4	4.8	5	4MZ	4CZ	
SM4F54A-MS	SM4F54CA-MS	54	60.0	66.3	1.0	87.1	4.5	5	4NE	4DE	
SM4F58A-MS	SM4F58CA-MS	58	64.4	71.2	1.0	93.6	4.2	5	4NG	4DG	
SM4F60A-MS	SM4F60CA-MS	60	66.7	73.7	1.0	96.8	4.1	5	4NK	4DK	
SM4F64A-MS	SM4F64CA-MS	64	71.1	78.6	1.0	103.0	3.8	5	4NM	4DM	
SM4F70A-MS	SM4F70CA-MS	70	77.8	86.0	1.0	113.0	3.5	5	4NP	4DP	
SM4F75A-MS	SM4F75CA-MS	75	83.3	92.1	1.0	121.0	3.3	5	4NR	4DR	
SM4F78A-MS	SM4F78CA-MS	78	86.7	95.8	1.0	126.0	3.1	5	4NT	4DT	
SM4F85A-MS	SM4F85CA-MS	85	94.4	104.0	1.0	137.0	2.9	5	4NV	4DV	
SM4F90A-MS		90	100.0	111.0	1.0	146.0	2.7	5	4NX		
SM4F100A-MS		100	111.0	123.0	1.0	162.0	2.4	5	4NZ		
SM4F110A-MS		110	122.0	135.0	1.0	177.0	2.2	5	4PE		
SM4F120A-MS		120	133.0	147.0	1.0	193.0	2.0	5	4PG		
SM4F130A-MS		130	144.0	159.0	1.0	209.0	1.9	5	4PK		
SM4F150A-MS		150	167.0	185.0	1.0	243.0	1.6	5	4PM		
SM4F160A-MS		160	178.0	197.0	1.0	259.0	1.5	5	4PP		
SM4F170A-MS		170	189.0	209.0	1.0	275.0	1.4	5	4PR		

Notes:

1. VBR measured after IT applied for 300 μs , IT= square wave pulse or equivalent
2. Surge current waveform per 10 x 1000 μs exponential wave and derated per Fig.2
3. All terms and symbols are consistent with ANSI/IEEE C62.35

Rating and characteristic curves (SM4F SERIES)

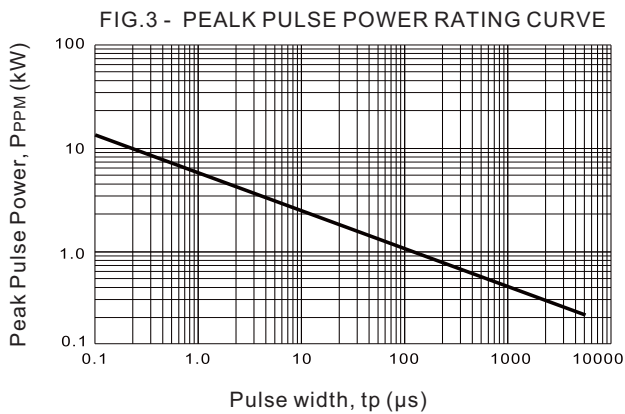
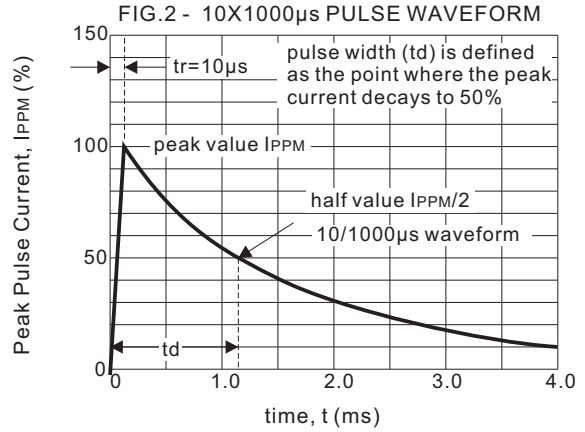
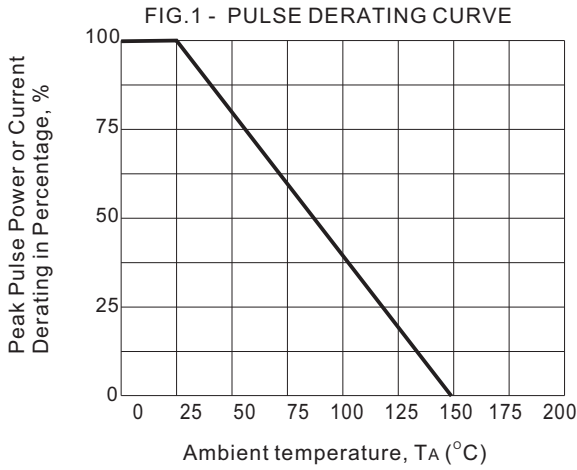
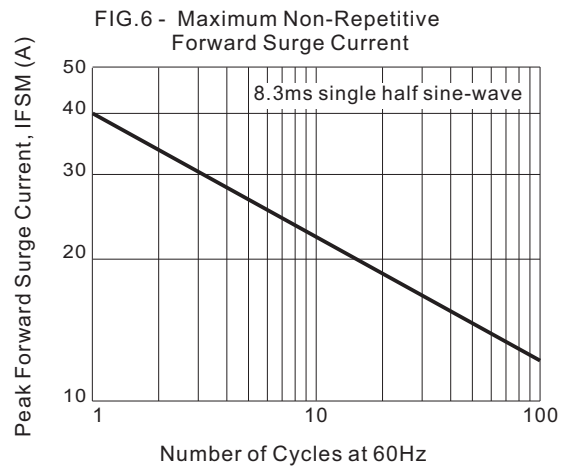
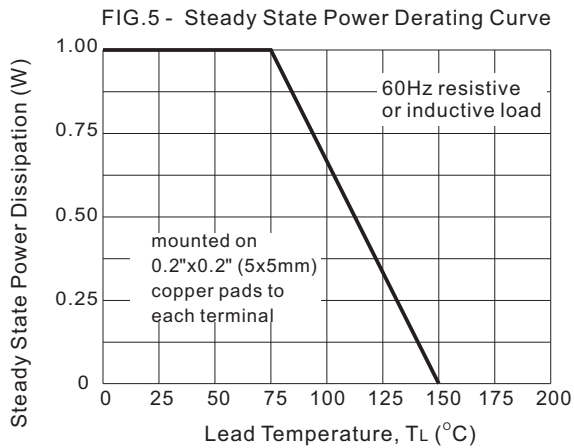
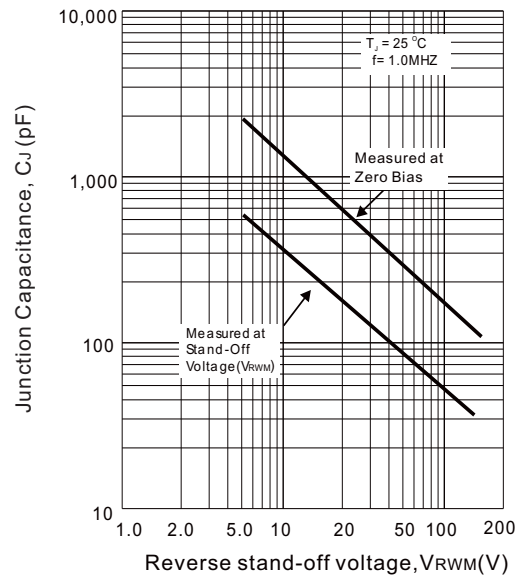





FIG.4 - TYPICAL JUNCTION CAPACITANCE



SM4F10A-MS THRU SM4F170A-MS SM4F10CA-MS THRU SM4F85CA-MS

Pinning information

Pin	Simplified outline	Symbol
Uni-Directional Pin1 cathode Pin2 anode		
Bi-Directional		

Marking

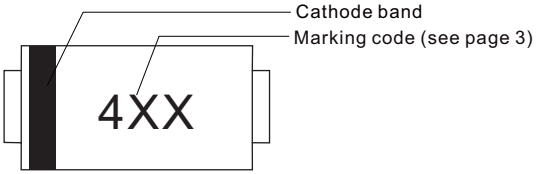
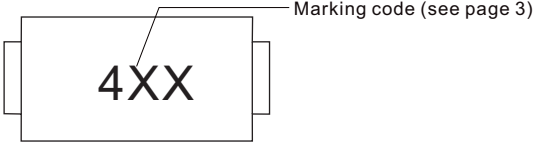
Type number	Example
Uni-Directional	
Bi-Directional	

Suggested solder pad layout

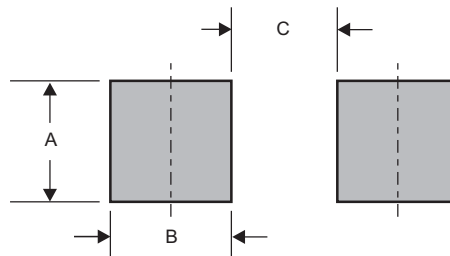

Dimensions in inches and (millimeters)

PACKAGE	A	B	C
SOD-123S	0.044 (1.10)	0.040 (1.00)	0.079 (2.00)

SM4F10A-MS THRU SM4F170A-MS
SM4F10CA-MS THRU SM4F85CA-MS

Packing information

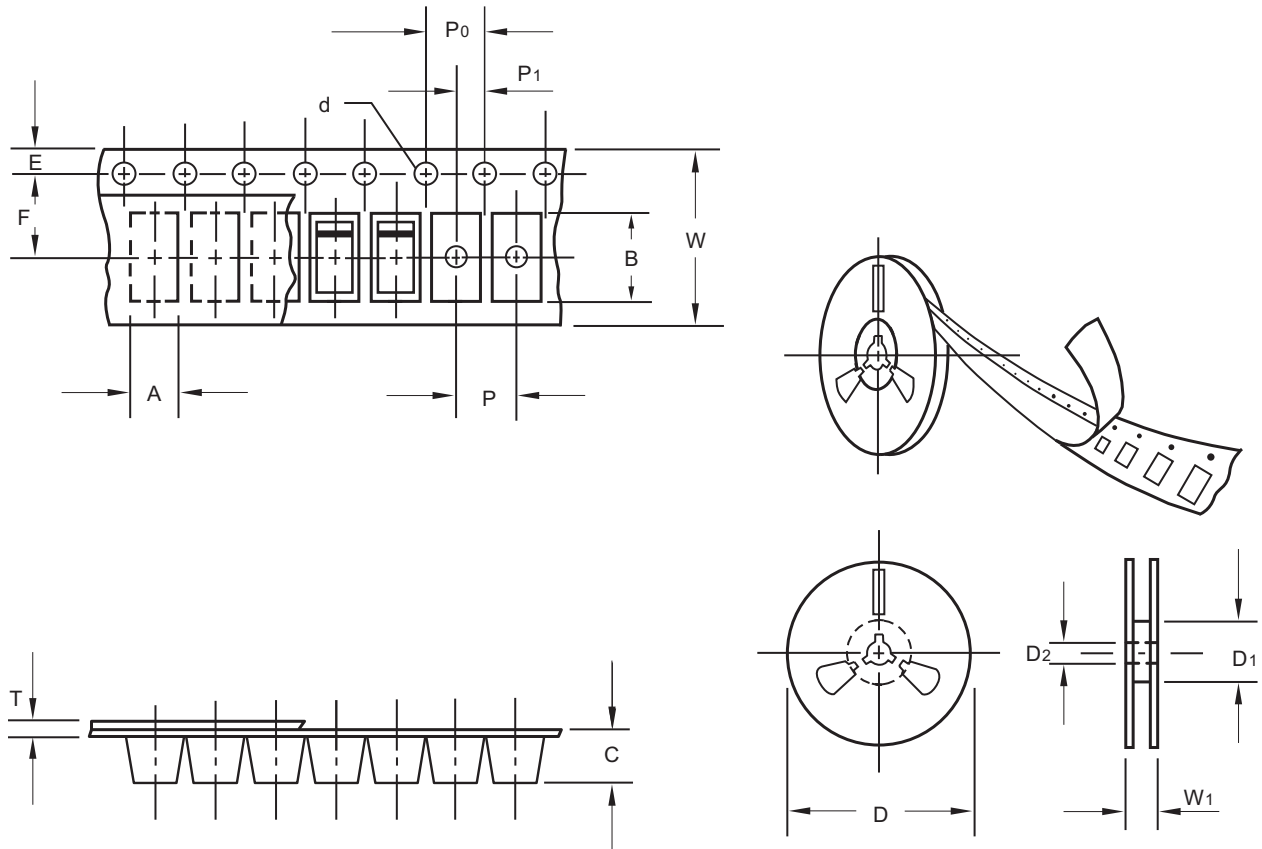

unit:mm

Item	Symbol	Tolerance	SOD-123S
Carrier width	A	0.1	2.00
Carrier length	B	0.1	3.85
Carrier depth	C	0.1	1.10
Sprocket hole	d	0.1	1.50
13" Reel outside diameter	D	2.0	-
13" Reel inner diameter	D1	min	-
7" Reel outside diameter	D	2.0	178.00
7" Reel inner diameter	D1	min	62.00
Feed hole diameter	D2	0.5	13.00
Sprocket hole position	E	0.1	1.75
Punch hole position	F	0.1	3.50
Punch hole pitch	P	0.1	4.00
Sprocket hole pitch	P0	0.1	4.00
Embossment center	P1	0.1	2.00
Overall tape thickness	T	0.1	0.23
Tape width	W	0.3	8.00
Reel width	W1	1.0	11.40

Note: Devices are packed in accordance with EIA standard RS-481-A and specifications listed above.

SM4F10A-MS THRU SM4F170A-MS SM4F10CA-MS THRU SM4F85CA-MS

Reel packing

PACKAGE	REEL SIZE	REEL (pcs)	COMPONENT SPACING (m/m)	BOX (pcs)	INNER BOX (m/m)	REEL DIA, (m/m)	CARTON SIZE (m/m)	CARTON (pcs)	APPROX. GROSS WEIGHT (kg)
SOD-123S	7"	3,000	4.0	30,000	183*123*183	178	382*257*387	240,000	9.5

Suggested thermal profiles for soldering processes

- 1.Storage environment: Temperature=5°C~40°C Humidity=55%±25%
- 2.Reflow soldering of surface-mount devices

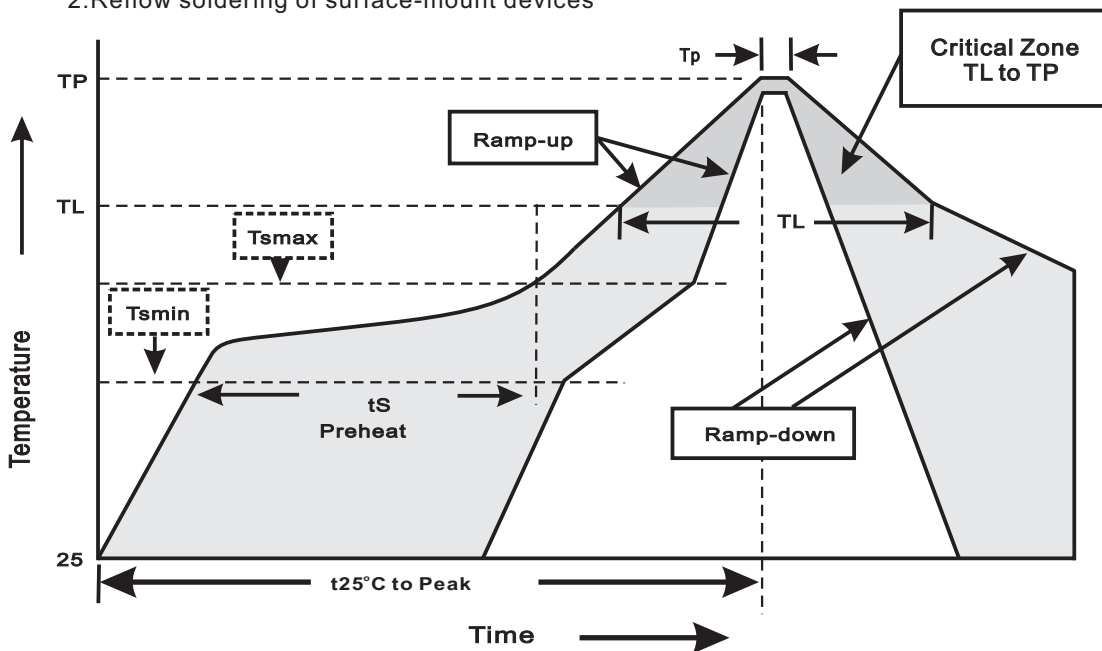

3.Reflow soldering

Profile Feature	Soldering Condition
Average ramp-up rate(T _L to T _P)	<3°C/sec
Preheat -Temperature Min(T _{smmin}) -Temperature Max(T _{smmax}) -Time(min to max)(t _s)	150°C 200°C 60~120sec
T _{smmax} to T _L -Ramp-upRate	<3°C/sec
Time maintained above: -Temperature(T _L) -Time(t _L)	217°C 60~260sec
Peak Temperature(T _P)	255°C-0/+5°C
Time within 5°C of actual Peak Temperature(t _P)	10~30sec
Ramp-down Rate	<6°C/sec
Time 25°C to Peak Temperature	<6minutes

SM4F10A-MS THRU SM4F170A-MS SM4F10CA-MS THRU SM4F85CA-MS

High reliability test capabilities

Item Test	Conditions	Reference
1. Solder Resistance	at 260±5°C for 10±2sec.	MIL-STD-750D METHOD-2031
2. Solderability	at 245±5°C for 5 sec.	MIL-STD-202F METHOD-208
3. High Temperature Reverse Bias	$V_{BR}=V_{BR\ N_{OM}}*80\%$ $T_J=150^\circ\text{C}$ for 168 hrs.	MIL-STD-750D METHOD-1038
4. Pressure Cooker	15P _{SIG} at $T_A=121^\circ\text{C}$ for 4 hrs.	JESD22-A102
5. Temperature Cycling	-55°C to +125°C dwelled for 30 min. and transferred for 5min. total 10 cycles.	MIL-STD-750D METHOD-1051
6. Humidity	at $T_A=85^\circ\text{C}$, RH=85% for 1000hrs.	MIL-STD-750D METHOD-1021
7. High Temperature Storage Life	at 175°C for 1000 hrs.	MIL-STD-750D METHOD-1031